

Prysmian
Group

We are with you, down to the core.

Prysmian mining cables – stronger, faster, safer.



 **PRYSMIAN**
 **Draka**
 **General Cable**



Linking the future

As the worldwide leader in the cable industry, Prysmian Group believes in the effective, efficient and sustainable supply of energy and information as a primary driver in the development of communities.

With this in mind, we provide major global organisations in many industries with best-in-class cable solutions, based on state-of-the-art technology. Through three renowned commercial brands – Prysmian, Draka and General Cable – based in almost 50 countries, we're constantly close to our customers, enabling them to further develop the world's energy and telecoms infrastructures, and achieve sustainable, profitable growth.

In our energy business, we design, produce, distribute and install cables and systems for the transmission and distribution of power at low, medium, high and extra-high voltage.

In telecoms, the Group is a leading manufacturer of all types of copper and fibre cables, systems and accessories – covering voice, video and data transmission.

Drawing on over 130 years' experience and continuously investing in R&D, we apply excellence, understanding and integrity to everything we do, meeting and exceeding the precise needs of our customers across all continents, at the same time shaping the evolution of our industry.

Contents

Linking the future	3
What links global expertise to the wheels of industry?	4
Mining cables	5
Made locally	6
What we offer	7
Our products and brands	8
TENAX-LUMEN	9
Applications – overview	10
<hr/>	
Opencast	17
Index	17
Product overview	18
Underground	95
Index	95
Product overview	96
Tunnelling	137
Index	137
Product overview	138
<hr/>	
Technical appendix	169



What links global expertise to the wheels of industry?

High-performing cable solutions to keep the wheels of industry turning

On every continent, in applications that range from air and rail transport infrastructure to heavy duty and renewable industries such as on- and offshore wind turbines, Prysmian's specialist cable solutions sit at the heart of significant international projects; supporting the work of major customers, with high-performing, durable and safe technology.

As the world leader in cabling, we draw on global expertise and local presence to work in close proximity with our customers, delivering products and service platforms built on easy contact, bespoke solutions and effective supply chain, meeting their specialised requirements, to help them drive the wheels of industry and achieve sustainable growth and profitability.

Mining cables

Introduction

The development of elastomeric power cables for safe and reliable mining and industrial applications has paralleled the development of the electric motor and power generation since the 19th century.

Elastomeric cables are the natural choice for applications where durability, flexibility, and safe operation under extreme environmental conditions are important. The Prysmian Group's elastomeric cables have been "field proven" in thousands of operations, and with continuous development, utilise the best features of cables offered around the world.

In Germany, as elsewhere, there are many established guidelines governing manufacture of mining and industrial cables.

Innovation in work practices, with more equipment operating at higher voltages, has required the continued development of new elastomeric cable designs. Ongoing development programs have also been required to continually improve the reliability and safety of current designs. The major design responsibility for the Prysmian Group is to ensure that cables supplied will operate reliably and safely under a wide range of conditions. Personnel often work close to energised cables, especially in underground mines. The cable construction and materials must be selected to provide maximum safety during both normal operation and in the case of cable failure.

Application

Opencast and underground mining requires ever-increasing performance of machines and methods. This has led to the large machines in use today. On bucket wheel and dragline excavators for instance, installed power of more than 15 MW and voltages up to 35 kV are no longer unusual.

These large, movable machines require medium voltage flexible reeling and trailing cables for power supply and are suitable for operation under the most extreme conditions.

Prysmian and Draka branded reeling and trailing cables for opencast and underground mining have been field-proven worldwide for decades.

In these mining applications, particular requirements such as mechanical strength and safety have led to the use of high-grade mechanically resistant rubber.

Prysmian Group has developed extensive know-how over many years about the special operational conditions of opencast and underground mining. The decisive factor was close cooperation with many significant mining companies.

The experience we gain every day contributes to the design of our mining cables. The high operational reliability and service life of Prysmian's reeling and trailing cables for mining is based on this experience.



Made locally

We've been making cables in Germany since 1858. Today we have 2000 skilled co-workers developing state-of-the-art cables in seven plants all over the country. We can offer a complete range of cables covering everything from the deep blue sea, mines and tunnels to skyscrapers and satellites.

Two of our facilities are Centres of Excellence including R&D departments in which we develop new solutions to meet your specific needs as well as the common challenges of tomorrow.

When that is not enough, we have the largest cable manufacturer in the world to our disposal, Prysmian Group. That includes 50 countries, 112 plants, 25 R&D centres and about 30,000 skilled professionals doing nothing but developing and producing cable solutions that will solve your current and future needs.





What we offer

Prysmian Group's Mining & Tunnelling cables offer significant benefits to a broad variety of specialized mining professionals such as OEMs, specifiers, contractors, installers, mining companies and more. These benefits include:

- **Unique mechanical performance**

Prysmian Group's Mining and Tunnelling cables have been designed to withstand extreme conditions in terms of:

- Tensile loads
- Torsional stresses occurring during misalignment of cable guidance systems and oblique pay out
- Minimum bending radius at any ambient temperature range and stress conditions
- High travel speeds and acceleration

- **Chemical and climate resistance**

Prysmian Group's Mining and Tunnelling cables have been designed to withstand the most severe conditions. For these applications Prysmian has developed the high performance compounds that are used in Mining and Tunnelling cables to guarantee resistance to extreme conditions (such as high-speed, oil and fuel, mud, moisture, and acids and basis), as well as to harsh environments (for instance, extreme low/hot temperature, UV irradiation and ozone).

- **Miniaturised**

Prysmian Group's Mining and Tunnelling cables have the smallest possible dimensions. For instance, in MV cables:

- Dimension – up to 30 % less and yet in strict compliance with the existing standards
- Weight – higher cable performance allow up to a 40 % reduction in the cable weight
- Robustness – higher physical/mechanical resistance, exceeding standard requirements in terms of abrasion, cut-through and repeated bending

- **Customised and multifunctional engineering**

Prysmian designs, compounds and builds cables according to specific customer needs. This allows us to have an exhaustive product range covering all functionalities (MV/LV, Instrumentation and Control, Optical fibres). Prysmian designs multifunctional cables from the simplest to the most sophisticated.

- **Longer lifetime**

Prysmian Group's Mining and Tunnelling cables guarantee an extended working lifetime (lower failure rate) in comparison with standard and traditional mining and tunneling cables. As a consequence the total cost of ownership is lower.

Our products and brands

Flexible cables

CORDAFLEX®

LHD cable for scoop operations 1 kV tough rubber-sheathed reeling cable.

OPTOFLEX®

Rubber-sheathed flexible fibre-optic cable.

PROTOLON®

Medium-voltage reeling cable, trailing cables, medium-voltage flexible cables.

PROTOMONT®

Heavy tough rubber-sheathed flexible cables.

SUPROMONT®

Medium-voltage mining-type cables for fixed installation.

TENAX®

Low- and medium-voltage flexible cables for underground and opencast application.

FELTOFLEX®

Medium-voltage flexible single core cables.

Special compounds

PROTODUR®

Insulating compound PVC used in SUPROMONT® cables.

PROTOFIRM®

Sheathing compound PCP used in CORDAFLEX®, PROTOLON®, PROTOMONT®, compound with special resistance to abrasion and tearing, 5GM5 quality.

PROTOLON®

Insulating compound EPR used in CORDAFLEX®, PROTOLON®, PROTOMONT®. Rubber compound with excellent electrical properties, resistant to heat and weather.

TENAX-LUMEN

- A luminescent mining cable.



MAIN FEATURES

- ✓ Brightly self-luminous in dark areas
- ✓ Exceptional cold resistance down to -50 °C
- ✓ Excellent impact and abrasion resistant
- ✓ Resistant to oil, ozone and moisture

“A security guarantee for personnel and equipment.”

Applications – overview

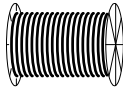

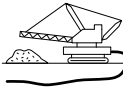
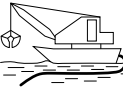
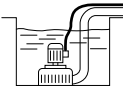
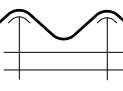
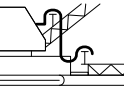
Opencast

Application groups:							
	Stacker/ Reclaimer	Bunker, Drills	Trailing	Dredge	Submersible pump	Semi-fixed	Semi-fixed
MEDIUM VOLTAGE REELING CABLES							
PROTOLON(M)-R	●	●	●	●	●	●	●
PROTOLON(M)-R FO	●	●	●	●	●	●	●
MEDIUM VOLTAGE TRAILING CABLES							
TENAX-SAS	●	●	●	●	●	●	●
PROTOLON(SB)	●	●	●	●	●	●	●
PROTOLON(SB-SAM)	●	●	●	●	●	●	●
TENAX-LUMEN	●	●	●	●	●	●	●
MEDIUM VOLTAGE DREDGING CABLES							
PROTOLON(ST).../3E	●	●	●	●	●	●	●
PROTOLON(ST)	●	●	●	●	●	●	●
PROTOLON(M)-F	●	●	●	●	●	●	●
CABLES FOR SEMI-FLEXIBLE INSTALLATION							
PROTOLON(M)-F	●	●	●	●	●	●	●
PROTOMONT NSSHOEU	●	●	●	●	●	●	●
PROTOMONT NSHXOEU	●	●	●	●	●	●	●
PROTOMONT(MT)	●	●	●	●	●	●	●
PROTOMONT EMV-FC	●	●	●	●	●	●	●
MEDIUM VOLTAGE SINGLE CORE CABLES							
FELTOFLEX NTMCW0EU	●	●	●	●	●	●	●
PROTOLON NTMCGCW0EU	●	●	●	●	●	●	●
PROTOLON(M) (N)TM..	●	●	●	●	●	●	●
CONTROL AND SIGNALING CABLES							
OPTOFLEX(M)	●	●	●	●	●	●	●
PROTOMONT(MSR)	●	●	●	●	●	●	●

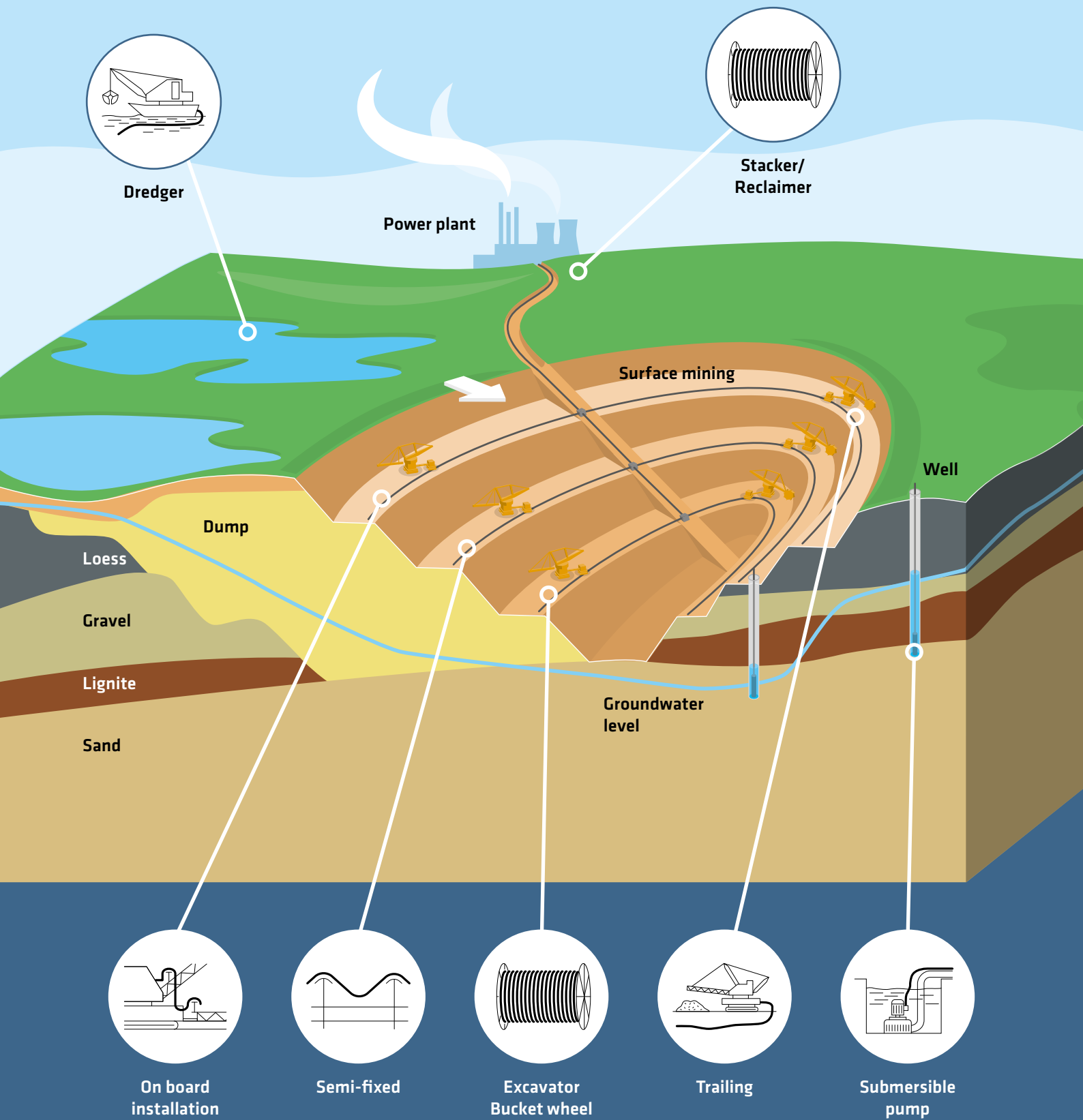
● Main application	● Suitable	● Not suitable
--------------------	------------	----------------

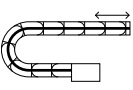
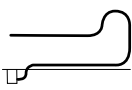
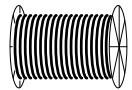

Underground

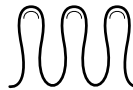
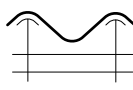
Application groups:						
	Shearer/ Chain	Shearer/ trailing	Reeling	Reeling	Festoon	Semi-fixed
SHEARER CABLES FOR CHAIN APPLICATION						
PROTOMONT(V) NSS...	●	●	●	●	●	●
PROTOMONT(V) NTS...	●	●	●	●	●	●
PROTOMONT(V0)	●	●	●	●	●	●
TENAX-CTE	●	●	●	●	●	●
SHEARER CABLES FOR FREE TRAILING						
PROTOMONT(Z)	●	●	●	●	●	●
UNDERGROUND REELING CABLES						
TENAX-LK	●	●	●	●	●	●
PROTOMONT(S)	●	●	●	●	●	●
CORDAFLEX(S)	●	●	●	●	●	●
PROTOMONT(M+)	●	●	●	●	●	●
CABLES FOR SEMI-FIXED INSTALLATION						
PROTOMONT Festoon	●	●	●	●	●	●
SUPROMONT (N)3GHSSYCY	●	●	●	●	●	●
SUPROMONT (N)3GHSSHCH	●	●	●	●	●	●
PROTOMONT(MT)	●	●	●	●	●	●
PROTOMONT NSSH../3E	●	●	●	●	●	●
PROTOMONT EMV-FC	●	●	●	●	●	●

● Main application	● Suitable	● Not suitable
--------------------	------------	----------------

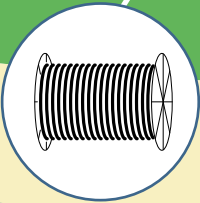
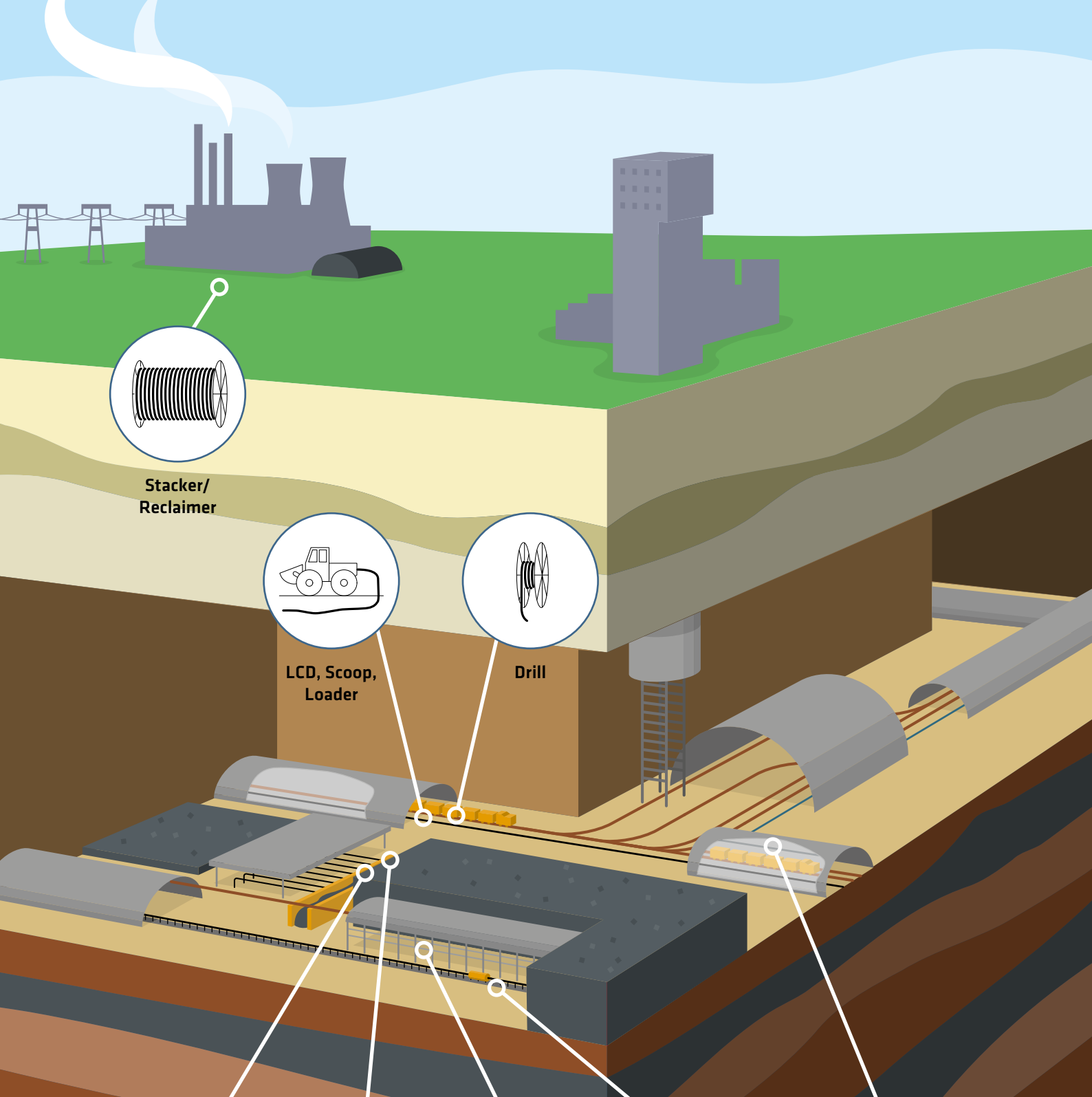

**Stacker/
Reclaimer**

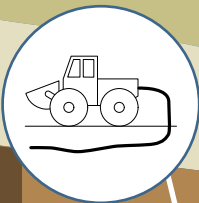

**LCD, Scoop,
Loader**

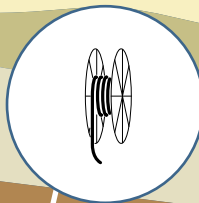

Drill



**Coal cutter -
free trailing**

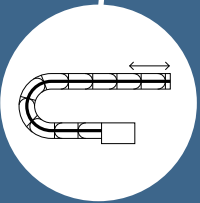

**Coal cutter -
chain application**

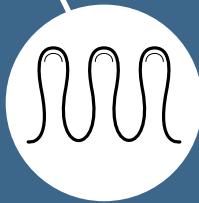

Festoon

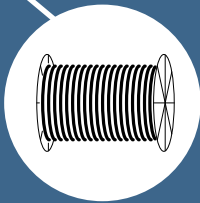

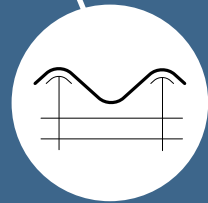

Shuttle car

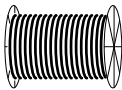

**Fixed
installation**

Tunnelling

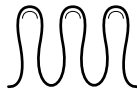
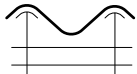
Application groups:				
	Reeling	Reeling	Festoon	Semi-fixed
TBM REELING				
PROTOMONT TBM (N)TSCGECW0EU	●	●	●	●
PROTOMONT TBM (N)TSCGECWHX0EU	●	●	●	●
TENAX-HTT	●	●	●	●
CABLES FOR SEMI-FIXED INSTALLATION				
PROTOMONT Festoon	●	●	●	●
SUPROMONT (N)3GHSSYCY	●	●	●	●
SUPROMONT (N)3GHSSHCH	●	●	●	●
PROTOMONT(MT)	●	●	●	●
PROTOMONT NSSH../3E	●	●	●	●
PROTOMONT EMV-FC	●	●	●	●

● Main application	● Suitable	● Not suitable
--------------------	------------	----------------

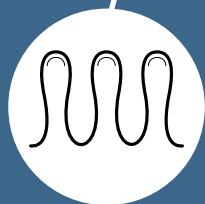
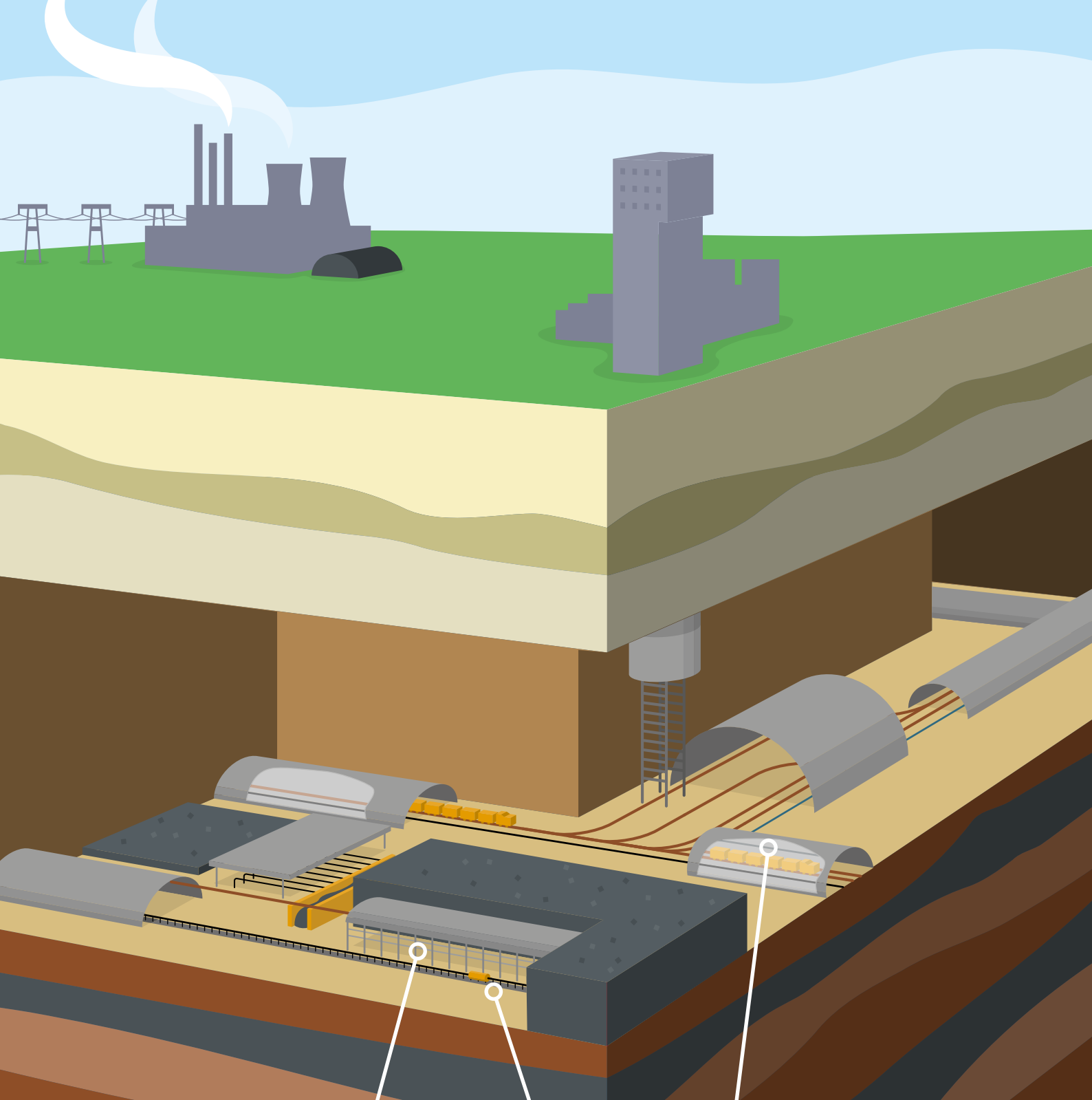

Festoon

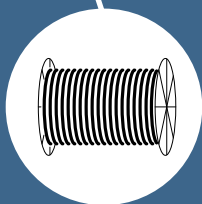

TBM Reeling

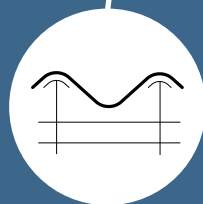

Fixed
installation



Opencast

Index

Product overview	18
MEDIUM VOLTAGE REELING CABLES	20
PROTOLON(M) R-(N)TSCGEW0EU 6 kV – 35 kV	20
PROTOLON(M) R-(N)TSCGEW0EU F0 6 kV – 35 kV	26
MEDIUM VOLTAGE TRAILING CABLES	32
TENAX-SAS NTSCGEW0EU 6 kV – 20 kV	32
PROTOLON(SB) NTSCGEW0EU 6 kV – 20 kV	36
PROTOLON(SB-SAM) (N)TSCGEW0EU 6 kV – 20 kV	40
TENAX-LUMEN (N)TSCGEH3S 6 kV – 10 kV	44
MEDIUM VOLTAGE DREDGING CABLES	46
PROTOLON(ST) .../3E NTSCGEW0EU 3 kV – 30 kV	46
PROTOLON(ST) NTSCGEW0EU 3 kV – 30 kV	50
PROTOLON(M) F (N)TSCGEW0EU 3 kV – 30 kV	54
CABLES FOR SEMI-FLEXIBLE INSTALLATION	58
PROTOLON(M) F (N)TSCGEW0EU 3 kV – 30 kV	58
PROTOMONT NSSHOEU 1 kV	62
PROTOMONT NSHXOEU 1 kV	66
PROTOMONT(MT) (N)SHOEU 1 kV	68
PROTOMONT EMV-FC (N)SSHC0EU 1 kV	72
PROTOMONT EMV-FC (N)SSHC0EU (-45°C) 1 kV	74
MEDIUM VOLTAGE SINGLE CORE CABLES	76
FELTOFLEX NTMCW0EU 6 kV – 30 kV	76
PROTOLON NTMCGCW0EU 6 kV – 30 kV	80
PROTOLON(M) (N)TMCWCW0EU 6 kV – 30 kV	84
CONTROL AND SIGNALING CABLES	88
OPTOFLEX(M) E9/125	88
OPTOFLEX(M) G50/125	89
OPTOFLEX(M) G62,5/125	90
PROTOMONT(MSR) 2YSLGCG0EU 250V	92

Product overview

MEDIUM VOLTAGE REELING CABLES

	PROTOLON(M) R-	PROTOLON(M) R-FO
Travel speed max. (m/min)	120	120
Permissible tensile force (N/mm ²)	20	20
Stability against torsion (°/m)	+/- 100	+/- 100
Sheath quality	5GM5	5GM5
Reversed bending stability	+++	+++
Flexibility	+++	+++
Resistance against water	+++	+++
S-bendings in operation	Multiple planes	Multiple planes
Temperature range in fully flexible operation (°C)	-35 to +60	-35 to +60
Approvals	Fire certificate, Gost -R/-K/-B	Fire certificate, Gost -R/-K/-B



MEDIUM VOLTAGE TRAILING CABLES

	TENAX-SAS	PROTOLON(SB)	PROTOLON (SB-SAM)	TENAX-LUMEN
Application	Trailing & Reeling	Trailing	Trailing	Trailing
Cable design	Acc. to VDE	Based on VDE	Based on VDE	Based on VDE
Permissible tensile force (N/mm ²)	25	15	20	25
Sheath quality	5GM5+	5GM5	5GM5	PUR
Sheath abrasion against surface	++++	+++	+++	+++
Reversed bending stability	+++	+++	+++	+++
Temperature range in fully flexible operation (°C)	-50 to +60	-20 to +60	-30 to +60	-50 to +60
Approvals	Fire certificate, Gost -R/-K/-B	DIN VDE 0250-813, MSHA P-189-4, Gost -R/-K/-B	Fire certificate, Gost -R/-K/-B	-

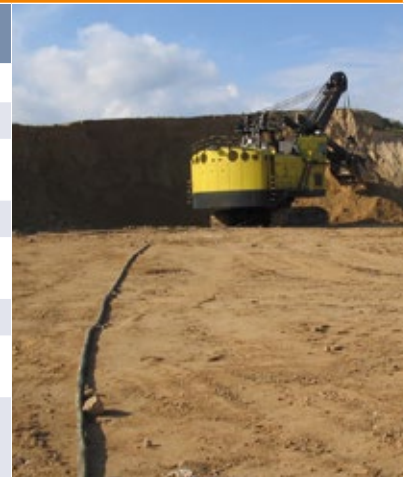

MEDIUM VOLTAGE DREDGING CABLES

	PROTOLON(ST) .../3E	PROTOLON(ST)	PROTOLON(M) F
Cable design	Acc. to VDE	Acc. to VDE	Based on VDE
Permissible tensile force N/mm ²	15	15	15
Stability against torsion (°/m)	+/- 25	+/- 100	+/- 100
Sheath quality	5GM3	5GM3	5GM3
Water compatibility acc. to VDE 0282 part 16	Excellent	Excellent	Very good
Stability against water penetration	+++	+++	++
Approvals	Fire certificate, Gost -R/-K/-B	Fire certificate, Gost -R/-K/-B	Fire certificate, Gost -R/-K/-B

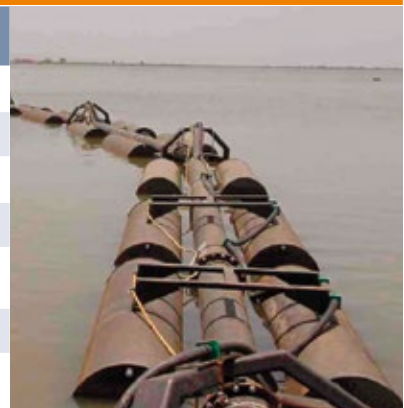

CABLES FOR SEMI-FLEXIBLE INSTALLATION

	PROTOLON(M) F	PROTOMONT NSSH0EU	PROTOMONT NSHX0EU	PROTOMONT (MT) (N)SH0EU	PROTOMONT EMV-FC
Application	MV semi-fixed	LV semi-fixed	LV semi-fixed	LV semi-fixed	LV frequency converter cable
Cable design	Based on VDE	Acc. to VDE	Based on VDE	Based on VDE	Based on VDE
Permissible tensile force (N/mm ²)	15	15	15	15	15
Sheath quality	5GM3	5GM5	5GM3 (halogen-free)	5GM5	5GM5
Sheath abrasion	++	+++	++	+++	+++
Reversed bending stability	++	++	++	++	++
Stability against water penetration	++	+++	+++	+++	+++
Temperature range in fully flexible operation (°C)	-25 to +60	-25 to +60	-25 to +60	-25 to +60	-25 to +60 special version: -45 to +60
Approvals	Fire certificate, Gost -R/-K/-B	MA - China, MSHA P-189-3, EAC certificate	-	VDE certificate with factory surveillance	MSHA P-189-3, EAC certificate

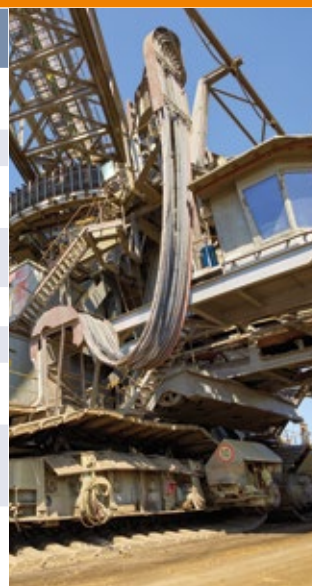

MEDIUM VOLTAGE SINGLE CORE CABLES

	FELTOFLEX NTMCW0EU	PROTOLON NTMCCW0EU	PROTOLON(M) (N)TMCCW0EU
Application	Flexible/semi-fixed	Flexible/semi-fixed	Flexible/semi-fixed
Voltage range (kV)	up to 35	up to 30	up to 30
Cable design	Acc. to VDE	Acc. to VDE	Based on VDE
Permissible tensile force (N/mm ²)	15	15	15
Sheath quality	5GM5	5GM3	5GM3
Outer semi-conductive layer	Cold removable	Warm removable	Cold removable
Stability against torsion (°/m)	+/- 25	+/- 25	+/- 25
Temperature range in fully flexible operation (°C)	-25 to +80	-25 to +60	-25 to +60
Approvals	Fire certificate, Gost -R/-K/-B	Fire certificate, Gost -R/-K/-B	Fire certificate, Gost -R/-K/-B



CONTROL AND SIGNALING CABLES

	OPTOFLEX(M)	PROTOMONT(MSR)
Application	Semi-fixed	Semi-fixed
Cable design	Flexible fibre optic cable	Rubber sheathed data cable
Special design features	Glass fibres in jelly filled tubes	Twisted pairs, overall screen
Permissible tensile force (N/mm ²)	max. 2000N	max. 15
Sheath quality	5GM5	EM2
Reversed bending stability	++	++
Temperature range in fully flexible operation (°C)	-30 to +60	-25 to +60
Approvals	-	EAC certificate



PROTOLON(M) R-(N)TSCGEW0EU 6 kV – 35 kV

Medium voltage reeling cable



Application

For connection of large material handling machines such as excavators, dumpers, mobile crusher in open-cast mines. Flexible MV reeling cable suitable for high mechanical stresses in conjunction with mono spiral reels and cylindrical reels.

Global data

Brand	PROTOLON(M)
Type designation	R-(N)TSCGEW0EU
Standard	Based on DIN VDE 0250-813
Certifications / Approvals	Fire Certificate of Russian Federation GOST -R/-K/-B

Design features

Conductor	Bare electrolytic copper, very finely stranded (class FS)
Insulation	High grade lead-free special compound based on HEPR (better than 3GI3) with improved mechanical and electrical characteristics (DIN VDE 0207-21)
Electrical field control	Inner and outer layer of semi-conductive rubber compound, cold strippable
Core identification	Natural colored with black semiconductive rubber and white numbers (1-3)
Core arrangement	Three-core design, with split earth conductor in the interstices
Inner sheath	Basic material EPR, compound type 5GM3
Torsion protection	Braid of polyester threads in a vulcanized bond between inner and outer sheath
Outer sheath	High grade chloroprene compound CR/PCP (better than 5GM5). Color: red (other colors available on request).

Electrical parameters

Rated voltage	3.6/6 kV	6/10 kV	8.7/15 kV	12/20 kV
Max. permissible operating voltage AC	4.2/7.2 kV	6,9/12 kV	10.4/18 kV	13.9/24 kV
Max. permissible operating voltage DC	5.4/10.8 kV	9/18 kV	13.5/27 kV	18/36 kV
AC test voltage - main cores	11 kV (5 Min.)	17 kV (5 Min.)	24 kV (5 Min.)	29 kV (5 Min.)
AC test voltage - control cores	2 kV	2 kV	2 kV	2 kV
	14/25 kV	18/30 kV	20/35 kV	
	17.3/30 kV	20.8/36 kV	24.2/42 kV	
	22.5/45 kV	27/54 kV	31.5/63 kV	
	36 kV (5 Min.)	43 kV (5 Min.)	50 kV (5 Min.)	
	2 kV	2 kV	2 kV	

Chemical parameters

Performance against fire	IEC 60332-1-2
Resistance to oil	IEC 60811-404
Weather resistance	Unrestricted use outdoors and indoors, resistant to ozone, UV and moisture
Water resistance	EN 50525-2-21 (HD 22.16)

Thermal parameters

Max. operating temperature of the conductor	90 °C
Max. short circuit temperature of the conductor	250 °C
Ambient temperature for fixed installation	min -40 °C ; max +80 °C
Ambient temperature in fully flexible operation	min -35 °C ; max +80 °C

Mechanical parameters

Max. tensile load on the conductor	20 N/mm ²
Max. tensile load on the conductor during acceleration	25 N/mm ²
Torsional stress +/-	100 °/m
Bending radii min.	Acc. to DIN VDE 0298 part 3
Min. distance with S-type directional changes	20 x D
Travel speed	On rewinding: up to 100 m/min Reeling operation: up to 120 m/min
Additional tests	Reversed bending test, torsional stress test, roller bending test (type C)

PROTOLON(M) R-(N)TSCGEW0EU 3.6/6 kV

Number of cores x cross section	Part number	MLFB Number	Conductor diameter max. mm	Outer diameter min. mm	Outer diameter max. mm	Weight (approx.) kg/km	Permissible tensile force max. N	Conductor resistance at 20°C max. Ω/km	Nominal operating capacitance μF/km	Inductance nom. mH/km	Current carrying capacity (1) A	Short Circuit Current (conductor) kA
3x25+3x25/3	20007613	5DK3923	7.1	35.5	38.5	2300	1500	0.7839	0.37	0.31	131	3.58
3x25+3x50/3	20171877	5DK3924	7.1	39.9	42.9	2760	1500	0.7839	0.37	0.35	131	3.58
3x35+3x25/3	20007426	5DK3900	8.4	39.3	42.3	2870	2100	0.554	0.43	0.3	162	5.01
3x35+3x50/3	20167803	5DK3926	8.4	42.2	45.2	3190	2100	0.554	0.43	0.32	162	5.01
3x50+3x25/3	20007893	5DK3915	10.1	42.8	45.8	3550	3000	0.386	0.49	0.28	202	7.15
3x50+3x50/3	20171416	5DK3908	10.1	42.8	45.8	3620	3000	0.386	0.49	0.3	202	7.15
3x70+3x35/3	20156763	5DK3914	11.8	46.4	49.4	4340	4200	0.272	0.55	0.27	250	10.01
3x70+3x50/3	20216565	5DK3913	11.8	46.6	49.6	4450	4200	0.272	0.55	0.27	250	10.01
3x95+3x50/3	20004527	5DK3916	13.8	51.5	55.5	5790	5700	0.206	0.63	0.26	301	13.59
3x120+3x70/3	20004525	5DK3907	15.5	55.2	59.2	6950	7200	0.161	0.7	0.25	352	17.16
3x150+3x70/3	20004528	5DK3917	17.4	59.2	63.2	8200	9000	0.129	0.76	0.25	404	21.45
3x150+3x95/3			17.4	59.2	63.2	7983	9000	0.129	0.76	0.25	404	21.45
3x185+3x95/3	20007425	5DK3918	19.2	64.4	68.4	9800	11100	0.106	0.82	0.24	461	26.46
3x185+3x120/3			19.2	64.4	68.4	9591	11100	0.106	0.82	0.24	461	26.46
3x240+3x120/3	20014799	5DK3883	22.1	70.6	74.6	12490	14400	0.0801	0.93	0.24	540	34.32
3x300+3x150/3	20014797	5DK3885	24.7	77.5	81.5	15270	18000	0.0641	1.03	0.23	620	42.9

PROTOLON(M) R-(N)TSCGEW0EU 6/10 kV

Number of cores x cross section	Part number	MLFB Number	Conductor diameter max. mm	Outer diameter min. mm	Outer diameter max. mm	Weight (approx.) kg/km	Permissible tensile force max. N	Conductor resistance at 20°C max. Ω/km	Nominal operating capacitance μF/km	Inductance nom. mH/km	Current carrying capacity (1) A	Short Circuit Current (conductor) kA
3x25+3x25/3	20007429	5DK4310	7.1	36.8	39.8	2360	1500	0.7839	0.33	0.32	131	3.58
3x25+3x50/3			7.1	41.3	44.3	2880	1500	0.7839	0.33	0.32	131	3.58
3x35+3x25/3	20006949	5DK4309	8.4	40.5	43.5	2960	2100	0.554	0.38	0.31	162	5.01
3x35+3x50/3	20018359	5DK4312	8.4	42.9	45.9	3350	2100	0.554	0.38	0.31	162	5.01
3x50+3x25/3	20008746	5DK4314	10.1	44.1	47.1	3610	3000	0.386	0.43	0.29	202	7.15
3x50+3x50/3	20031763	5DK4316	10.1	44.1	47.1	3820	3000	0.386	0.43	0.29	202	7.15
3x70+3x35/3	20004607	5DK4317	11.8	47.9	50.9	4510	4200	0.272	0.49	0.28	250	10.01
3x70+3x50/3	20004608	5DK4318	11.8	47.9	50.9	4730	4200	0.272	0.49	0.28	250	10.01
3x95+3x50/3	20004611	5DK4321	13.8	52.8	56.8	5810	5700	0.206	0.56	0.27	301	13.59
3x120+3x70/3	20001446	5DK4322	15.5	56.4	60.4	7110	7200	0.161	0.62	0.26	352	17.16
3x150+3x70/3	20007824	5DK4323	17.4	61.9	65.9	8380	9000	0.129	0.67	0.25	404	21.45
3x185+3x95/3	20008329		19.2	65.7	69.7	10030	11100	0.106	0.73	0.25	461	26.46
3x240+3x120/3	20170681		22.1	73.3	77.3	12570	14400	0.0801	0.82	0.24	540	34.32
3x300+3x150/3	20233807	5DK4326	24.7	78.7	82.7	15060	18000	0.0641	0.91	0.24	620	42.9

(1) Nominal current carrying capacity for rubber cables laid on a surface, at 30°C ambient temperature (see also VDE 0298-4, Table 15). For derating-factors see tables in Technical Appendix.

Special designs available upon request, e.g.:

- different outer sheath colors
- special types for cold regions (-45°C reeling)
- halogen-free version with 5GM3 outer sheath
- integration of additional control cores in the interstices

PROTOLON(M) R-(N)TSCGEW0EU 8.7/15 kV

Number of cores x cross section	Part number	MLFB Number	Conductor diameter max. mm	Outer diameter min. mm	Outer diameter max. mm	Weight (approx.) kg/km	Permissible tensile force max. N	Conductor resistance at 20°C max. Ω/km	Nominal operating capacitance μF/km	Inductance nom. mH/km	Current carrying capacity (1) A	Short Circuit Current (conductor) kA
3x25+3x25/3	20174026		7.1	41.4	44.4	2700	1500	0.7839	0.34	0.26	139	3.58
3x25+3x50/3		5DK5122	7.1	43.6	46.6	3080	1500	0.7839	0.34	0.26	139	3.58
3x35+3x25/3	20153602		8.4	43.9	46.9	3190	2100	0.554	0.29	0.33	172	5.01
3x35+3x50/3			8.4	43.9	46.9	3380	2100	0.554	0.29	0.33	172	5.01
3x50+3x25/3	20175507		10.1	44.1	47.1	3890	3000	0.386	0.33	0.31	215	7.15
3x50+3x50/3	20004682	5DK5132	10.1	57	60	5790	3000	0.386	0.33	0.31	215	7.15
3x70+3x35/3	20233253		11.8	52	56	5010	4200	0.272	0.38	0.3	265	10.01
3x70+3x50/3			11.8	52	56	5130	4200	0.272	0.38	0.3	265	10.01
3x95+3x50/3	20004683	5DK5135	13.8	66.2	70.2	8220	5700	0.206	0.41	0.29	319	13.59
3x120+3x70/3			15.5	61.3	65.3	7580	7200	0.161	0.45	0.28	371	17.16
3x150+3x70/3			17.4	65.3	69.3	8980	9000	0.129	0.5	0.27	428	21.45
3x185+3x95/3	20163255		19.2	69.1	73.1	10280	11100	0.106	0.54	0.26	488	26.46
3x240+3x120/3			22.1	76.6	80.6	13110	14400	0.0801	0.6	0.26	574	34.32
3x300+3x150/3			24.7	83.5	88.5	16010	18000	0.0641	0.66	0.25	660	42.9

PROTOLON(M) R-(N)TSCGEW0EU 12/20 kV

Number of cores x cross section	Part number	MLFB Number	Conductor diameter max. mm	Outer diameter min. mm	Outer diameter max. mm	Weight (approx.) kg/km	Permissible tensile force max. N	Conductor resistance at 20°C max. Ω/km	Nominal operating capacitance μF/km	Inductance nom. mH/km	Current carrying capacity (1) A	Short Circuit Current (conductor) kA
3x25+3x25/3	20008326	5DK5866	7.1	44.1	47.1	3110	1500	0.7839	0.23	0.36	139	3.58
3x25+3x50/3			7.1	44.1	47.1	3160	1500	0.7839	0.23	0.36	139	3.58
3x35+3x25/3	20025024	5DK5868	8.4	46.8	49.8	3620	2100	0.554	0.26	0.34	172	5.01
3x35+3x50/3			8.4	46.8	49.8	3660	2100	0.554	0.26	0.34	172	5.01
3x50+3x25/3	20142156	5DK5870	10.1	51.3	55.3	4490	3000	0.386	0.29	0.32	215	7.15
3x50+3x50/3	20015893	5DK5872	10.1	51.3	55.3	4720	3000	0.386	0.29	0.32	215	7.15
3x70+3x35/3	20151773		11.8	55	59	5360	4200	0.272	0.33	0.31	265	10.01
3x70+3x50/3	20269483		11.8	55	59	5480	4200	0.272	0.33	0.31	265	10.01
3x95+3x50/3	20004728	5DK5875	13.8	61.8	65.8	6800	5700	0.206	0.37	0.3	319	13.59
3x95+3x70/3	20015538	5DK5876	13.8	59.2	63.2	7090	5700	0.206	0.37	0.3	319	13.59
3x120+3x70/3			15.5	64.2	68.2	7980	7200	0.161	0.4	0.29	371	17.16
3x150+3x70/3			17.4	68.2	72.2	9380	9000	0.129	0.44	0.28	428	21.45
3x185+3x95/3	20161593		19.2	73.4	77.4	10990	11100	0.106	0.48	0.27	488	26.46
3x240+3x120/3	20157265		22.1	78.3	82.3	14200	14400	0.0801	0.54	0.26	574	34.32
3x300+3x150/3			24.7	86.4	91.4	16560	18000	0.0641	0.59	0.26	660	42.9

(1) Nominal current carrying capacity for rubber cables laid on a surface, at 30°C ambient temperature (see also VDE 0298-4, Table 15). For derating-factors see tables in Technical Appendix.

Special designs available upon request, e.g.:

- different outer sheath colors
- special types for cold regions (-45°C reeling)
- halogen-free version with 5GM3 outer sheath
- integration of additional control cores in the interstices

PROTOLON(M) R-(N)TSCGEWUEU 14/25 kV

Number of cores x cross section	Part number	MLFB Number	Conductor diameter max. mm	Outer diameter min. mm	Outer diameter max. mm	Weight (approx.) kg/km	Permissible tensile force max. N	Conductor resistance at 20°C max. Ω/km	Nominal operating capacitance μF/km	Inductance nom. mH/km	Current carrying capacity (1) A	Short Circuit Current (conductor) kA
3x25+3x25/3	20258099		7.1	47.9	50.9	3360	1500	0.7839	0.2	0.38	139	3.58
3x25+3x50/3			7.1	47.9	50.9	3540	1500	0.7839	0.2	0.38	139	3.58
3x35+3x25/3	20193175		8.4	51.5	55.5	4050	2100	0.554	0.22	0.36	172	5.01
3x35+3x50/3			8.4	51.5	55.5	4240	2100	0.554	0.22	0.36	172	5.01
3x50+3x25/3			10.1	55.2	59.2	4820	3000	0.386	0.25	0.34	215	7.15
3x50+3x50/3	20009369		10.1	51.2	55.2	5010	3000	0.386	0.25	0.34	215	7.15
3x70+3x35/3	20069172	5DK6125	11.8	58.8	62.8	6030	4200	0.272	0.28	0.33	265	10.01
3x70+3x50/3	20008713	5DK6124	11.8	58.8	62.8	6180	4200	0.272	0.28	0.33	265	10.01
3x95+3x50/3	20182413	5DK6127	13.8	64.4	68.4	7280	5700	0.206	0.31	0.31	319	13.59
3x120+3x70/3	20257651		15.8	68	72	8850	7200	0.161	0.34	0.3	371	17.16
3x150+3x70/3			17.4	73.4	77.4	10230	9000	0.129	0.37	0.29	428	21.45
3x185+3x95/3			19.2	77.3	81.3	11610	11100	0.106	0.4	0.28	488	26.46
3x240+3x120/3		5DK6132	22.1	84.7	89.7	14660	14400	0.0801	0.45	0.27	574	34.32
3x300+3x150/3	20233808		24.7	91.8	96.8	17330	18000	0.0641	0.49	0.27	660	42.9

PROTOLON(M) R-(N)TSCGEWUEU 18/30 kV

Number of cores x cross section	Part number	MLFB Number	Conductor diameter max. mm	Outer diameter min. mm	Outer diameter max. mm	Weight (approx.) kg/km	Permissible tensile force max. N	Conductor resistance at 20°C max. Ω/km	Nominal operating capacitance μF/km	Inductance nom. mH/km	Current carrying capacity (1) A	Short Circuit Current (conductor) kA
3x25+3x25/3			7.1	52.2	56.2	3900	1500	0.7839	0.18	0.4	139	3.58
3x25+3x50/3			7.1	52.2	56.2	4090	1500	0.7839	0.18	0.4	139	3.58
3x35+3x25/3			8.4	55	59	4450	2100	0.554	0.19	0.38	172	5.01
3x35+3x50/3			8.4	55	59	4640	2100	0.554	0.19	0.38	172	5.01
3x50+3x25/3	20181197		10.1	58.6	62.6	5250	3000	0.386	0.22	0.36	215	7.15
3x50+3x50/3	20136772		10.1	58.6	62.6	5430	3000	0.386	0.22	0.36	215	7.15
3x70+3x35/3	20159423		11.8	62.5	66.5	6500	4200	0.272	0.24	0.34	265	10.01
3x70+3x50/3	20004740	5DK6603	11.8	63.6	67.6	6840	4200	0.272	0.24	0.34	265	10.01
3x95+3x50/3	20143262	5DK6613	13.8	67.9	71.9	8160	5700	0.206	0.27	0.33	319	13.59
3x120+3x70/3	20006962	5DK6607	15.5	72.8	76.8	9630	7200	0.161	0.29	0.31	371	17.16
3x150+3x70/3			17.4	76.9	80.9	10780	9000	0.129	0.32	0.3	428	21.45
3x185+3x95/3			19.2	80.6	84.6	12170	11100	0.106	0.34	0.3	488	26.46
3x240+3x120/3	20261692		22.1	88.1	93.1	15280	14400	0.0801	0.38	0.28	574	34.32
3x300+3x150/3			24.7	94.6	99.6	18200	18000	0.0641	0.42	0.28	660	42.9

(1) Nominal current carrying capacity for rubber cables laid on a surface, at 30°C ambient temperature (see also VDE 0298-4, Table 15). For derating-factors see tables in Technical Appendix.

Special designs available upon request, e.g.:

- different outer sheath colors
- special types for cold regions (-45°C reeling)
- halogen-free version with 5GM3 outer sheath
- integration of additional control cores in the interstices

PROTOLON(M) R-(N)TSCGEW0EU 20/35 kV

Number of cores x cross section	Part number	MLFB Number	Conductor diameter max. mm	Outer diameter min. mm	Outer diameter max. mm	Weight (approx.) kg/km	Permissible tensile force max. N	Conductor resistance at 20°C max. Ω/km	Nominal operating capacitance μF/km	Inductance nom. mH/km	Current carrying capacity (1) A	Short Circuit Current (conductor) kA
3x25+3x25/3			7.1	56.8	60.8	4450	1500	0.7839	0.16	0.42	139	3.58
3x35+3x25/3	20218424	5DK7***	8.4	61.1	65.1	5260	2100	0.554	0.18	0.4	172	5.01
3x50+3x25/3			10.1	64.6	68.6	6080	3000	0.386	0.2	0.37	215	7.15
3x50+3x50/3	20226377		10.1	63.2	67.2	6500	3000	0.386	0.2	0.37	215	7.15
3x70+3x35/3			11.8	68.2	72.2	7160	4200	0.272	0.23	0.36	265	10.01
3x70+3x50/3	20004750	5DK7304	11.8	68.2	72.2	7590	4200	0.272	0.25	0.36	265	10.01
3x120+3x70/3	20171878		15.5	76.4	81.4	9850	7200	0.161	0.28	0.34	371	17.16

(1) Nominal current carrying capacity for rubber cables laid on a surface, at 30°C ambient temperature (see also VDE 0298-4, Table 15). For derating-factors see tables in Technical Appendix.

Special designs available upon request, e.g.:

- different outer sheath colors
- special types for cold regions (-45°C reeling)
- halogen-free version with 5GM3 outer sheath
- integration of additional control cores in the interstices

PROTOLON(M) R-(N)TSCGEWOU FO 6 kV – 35 kV

Medium voltage reeling cable with integrated fiber-optics



Application

For connection of large material handling machines such as excavators, dumpers, mobile crushers in open-cast mines. Flexible MV reeling cable suitable for high mechanical stresses in conjunction with mono-spiral reels and cylindrical reels.

Global data

Brand	PROTOLON(M)
Type designation	R-(N)TSCGEWOU
Standard	Based on DIN VDE 0250-813
Certifications / Approvals	Fire Certificate of Russian Federation GOST -R/-K/-B

Design features

Conductor	Bare electrolytic copper, very finely stranded (class FS)
Insulation	High grade lead-free special compound based on HEPR (better than 3GI3) with improved mechanical and electrical characteristics (DIN VDE 0207-21)
Electrical field control	Inner and outer layer of semi-conductive rubber compound, cold strippable
Core identification	Natural colored with black semi conductive rubber and white numbers (1-3)
Optical fiber	Inner core diameter of fiber 9 µm, 62.5 µm or 50 µm; Diameter over cladding 125 µm; Diameter over coating 250 µm; Designs up to 24 fibers available.
	Fiber G50/125 Attenuation at 850 nm: <2.8 dB/km Attenuation at 1310 nm: <0.8 dB/km Bandwith at 850 nm: >400 MHz Bandwith at 1300 nm: >1200 MHz Numerical aperture: 0.20 +/- 0.02
	Fiber G62.5/125 Attenuation at 850 nm: <3.3 dB/km Attenuation at 1310 nm: <0.9 dB/km Bandwith at 850 nm: >400 MHz Bandwith at 1300 nm: >600 MHz Numerical aperture: 0.275 +/- 0.02
	Fiber E9/125 Attenuation at 1310 nm: <0.4 dB/km Attenuation at 1550 nm: <0.3 dB/km Numerical aperture: 0.14 +/- 0.02 Chromatic dispersion at 1310 nm: <3.5 ps/nm km Chromatic dispersion at 1550 nm: <18 ps/nm km
Fiber coding	Color coding of the fibers and buffering tube for identification of the fiber type
Fiber covering	Loose tube with filling compound, Basic material: ETFE, Compound: 7YI 1, Natural color
Arrangement of fiber optic elements	Six tubes laid-up around a central support element, with up to 4 fibers in each tube.
Core arrangement	Three-core design, with split earth conductor and fiber-optic element in the interstices
Inner sheath	Basic material EPR, compound type 5GM3
Torsion protection	Braid of polyester threads in a vulcanized bond between inner and outer sheath
Outer sheath	High grade chloroprene compound CR/PCP (better than 5GM5). Color: red (other colors available on request).

Electrical parameters

Rated voltage	3.6/6 kV	6/10 kV	8.7/15 kV	12/20 kV
Max. permissible operating voltage AC	4.2/7.2 kV	6,9/12 kV	10.4/18 kV	13.9/24 kV
Max. permissible operating voltage DC	5.4/10.8 kV	9/18 kV	13.5/27 kV	18/36 kV
AC test voltage - main cores	11 kV (5 Min.)	17 kV (5 Min.)	24 kV (5 Min.)	29 kV (5 Min.)
AC test voltage - control cores	2 kV	2 kV	2 kV	2 kV
	18/30 kV	14/25 kV	20/35 kV	
	20.8/36 kV	17.3/30 kV	24.2/42 kV	
	27/54 kV	22.5/45 kV	31.5/63 kV	
	43 kV (5 Min.)	36 kV (5 Min.)	50 kV (5 Min.)	
	2 kV	2 kV	2 kV	

Chemical parameters

Performance against fire	IEC 60332-1-2
Resistance to oil	IEC 60811-404
Weather resistance	Unrestricted use outdoors and indoors, resistant to ozone, UV and moisture
Water resistance	EN 50525-2-21 (HD 22.16)

Thermal parameters

Max. operating temperature of the conductor	90 °C
Max. short circuit temperature of the conductor	250 °C
Ambient temperature for fixed installation	min -40 °C ; max +80 °C
Ambient temperature in fully flexible operation	min -35 °C ; max +80 °C

Mechanical parameters

Max. tensile load on the conductor	20 N/mm ²
Max. tensile load on the conductor during acceleration	25 N/mm ²
Torsional stress +/-	100 °/m
Bending radii min.	Acc. to DIN VDE 0298 part 3
Min. distance with S-type directional changes	20 x OD (OD = outer diameter)
Travel speed	On rewinding: up to 100 m/min Reeling operation: up to 120 m/min
Additional tests	Reversed bending test, torsional stress test, roller bending test (type C)

PROTOLON(M) R-(N)TSCGEWOEU 3.6/6 kV

Number of cores x cross section	Conductor diameter max. mm	Outer diameter min. mm	Outer diameter max. mm	Weight (approx.) kg/km	Permissible tensile force max. N	Conductor resistance at 20°C max. Ω/km	Nominal operating capacitance μF/km	Inductance nom. mH/km	Current carrying capacity (1) A	Short Circuit Current (conductor) kA
3x25+2x25/2+FO	7.1	40	43	2590	1500	0.7839	0.37	0.35	131	3.58
3x25+2x50/2+FO	7.1	42.6	45.6	2900	1500	0.7839	0.37	0.38	131	3.58
3x35+2x25/2+FO	8.4	41.6	44.6	2960	2100	0.554	0.43	0.32	162	5.01
3x35+2x50/2+FO	8.4	44.5	47.5	3300	2100	0.554	0.43	0.35	162	5.01
3x50+2x25/2+FO	10.1	42.8	45.8	3430	3000	0.386	0.49	0.28	202	7.15
3x50+2x50/2+FO	10.1	46.4	49.4	3950	3000	0.386	0.49	0.31	202	7.15
3x70+2x35/2+FO	11.8	46.4	49.4	4350	4200	0.272	0.55	0.27	250	10.01
3x70+2x50/2+FO	11.8	49.8	53.8	4700	4200	0.272	0.55	0.29	250	10.01
3x95+2x50/2+FO	13.8	51.5	55.5	5630	5700	0.206	0.63	0.26	301	13.59
3x120+2x70/2+FO	15.5	55.2	59.2	6800	7200	0.161	0.7	0.25	352	17.16
3x150+2x70/2+FO	17.4	59.2	63.2	7970	9000	0.129	0.76	0.25	404	21.45
3x185+2x95/2+FO	19.2	64.4	68.4	9630	11100	0.106	0.82	0.24	461	26.46
3x240+2x120/2+FO	22.1	70.6	74.6	12160	14400	0.0801	0.93	0.24	540	34.32
3x300+2x150/2+FO	24.7	77.5	81.5	14880	18000	0.0641	1.03	0.23	620	42.9

PROTOLON(M) R-(N)TSCGEWOEU 6/10 kV

Number of cores x cross section	Conductor diameter max. mm	Outer diameter min. mm	Outer diameter max. mm	Weight (approx.) kg/km	Permissible tensile force max. N	Conductor resistance at 20°C max. Ω/km	Nominal operating capacitance μF/km	Inductance nom. mH/km	Current carrying capacity (1) A	Short Circuit Current (conductor) kA
3x25+2x25/2+FO	7.1	41.3	44.3	2660	1500	0.7839	0.33	0.35	131	3.58
3x25+2x50/2+FO	7.1	43.6	46.6	2900	1500	0.7839	0.33	0.38	131	3.58
3x35+2x25/2+FO	8.4	42.9	45.9	3070	2100	0.554	0.38	0.33	162	5.01
3x35+2x50/2+FO	8.4	45.2	48.2	3500	2100	0.554	0.38	0.35	162	5.01
3x50+2x25/2+FO	10.1	44.1	47.1	3560	3000	0.386	0.43	0.29	202	7.15
3x50+2x50/2+FO	10.1	47.8	50.8	3900	3000	0.386	0.43	0.32	202	7.15
3x70+2x35/2+FO	11.8	47.7	50.7	4480	4200	0.272	0.49	0.28	250	10.01
3x70+2x50/2+FO	11.8	51.2	55.2	5010	4200	0.272	0.49	0.3	250	10.01
3x95+2x50/2+FO	13.8	52.8	56.8	5770	5700	0.206	0.56	0.27	301	13.59
3x120+2x70/2+FO	15.5	56.4	60.4	6950	7200	0.161	0.62	0.25	352	17.16
3x150+2x70/2+FO	17.4	61.9	65.9	8350	9000	0.129	0.67	0.25	404	21.45
3x185+2x95/2+FO	19.2	65.7	69.7	9810	11100	0.106	0.73	0.24	461	26.46
3x240+2x120/2+FO	22.1	73.3	77.3	12600	14400	0.0801	0.82	0.24	540	34.32
3x300+2x150/2+FO	24.7	78.7	82.7	15090	18000	0.0641	0.91	0.23	620	42.9

(1) Nominal current carrying capacity for rubber cables laid on a surface, at 30°C ambient temperature (see also VDE 0298-4, Table 15). For derating-factors see tables in Technical Appendix.

Special designs available upon request, e.g.:

- different outer sheath colors
- special types for cold regions (-45°C reeling)
- halogen-free version with 5GM3 outer sheath
- integration of additional control cores in the interstices

Design with 6, 12, 18 or 24 fibers, in G62,5, G50 and E9 available upon request. Further combination with different fiber types is also possible

PROTOLON(M) R-(N)TSCGEW0EU 8.7/15 kV

Number of cores x cross section	Conductor diameter max. mm	Outer diameter min. mm	Outer diameter max. mm	Weight (approx.) kg/km	Permissible tensile force max. N	Conductor resistance at 20°C max. Ω/km	Nominal operating capacitance μF/km	Inductance nom. mH/km	Current carrying capacity (1) A	Short Circuit Current (conductor) kA
3x25+2x25/2+FO	7.1	43.6	46.6	2910	1500	0.7839	0.26	0.36	139	3.58
3x25+2x50/2+FO	7.1	45.9	48.9	3250	1500	0.7839	0.26	0.38	139	3.58
3x35+2x25/2+FO	8.4	43.9	46.9	3180	2100	0.554	0.29	0.33	172	5.01
3x35+2x50/2+FO	8.4	47.5	50.5	3600	2100	0.554	0.29	0.35	172	5.01
3x50+2x25/2+FO	10.1	47.5	50.5	3900	3000	0.386	0.33	0.31	215	7.15
3x50+2x50/2+FO	10.1	51	55	4500	3000	0.386	0.33	0.32	215	7.15
3x70+2x35/2+FO	11.8	52	56	5020	4200	0.272	0.37	0.3	265	10.01
3x70+2x50/2+FO	11.8	52	56	5130	4200	0.272	0.37	0.3	265	10.01
3x95+2x50/2+FO	13.8	56.2	60.2	6180	5700	0.206	0.41	0.28	319	13.59
3x120+2x70/2+FO	15.5	61.3	65.3	7600	7200	0.161	0.45	0.27	371	17.16
3x150+2x70/2+FO	17.4	65.3	69.3	8820	9000	0.129	0.5	0.27	428	21.45
3x185+2x95/2+FO	19.2	69.1	73.1	10300	11100	0.106	0.54	0.26	488	26.46
3x240+2x120/2+FO	22.1	76.6	80.6	13140	14400	0.0801	0.6	0.25	574	34.32
3x300+2x150/2+FO	24.7	83.5	88.5	16040	18000	0.0641	0.66	0.25	660	42.9

PROTOLON(M) R-(N)TSCGEW0EU 12/20 kV

Number of cores x cross section	Conductor diameter max. mm	Outer diameter min. mm	Outer diameter max. mm	Weight (approx.) kg/km	Permissible tensile force max. N	Conductor resistance at 20°C max. Ω/km	Nominal operating capacitance μF/km	Inductance nom. mH/km	Current carrying capacity (1) A	Short Circuit Current (conductor) kA
3x25+2x25/2+FO	7.1	44.1	47.1	2980	1500	0.7839	0.23	0.36	139	3.58
3x25+2x50/2+FO	7.1	47	50	3300	1500	0.7839	0.23	0.39	139	3.58
3x35+2x25/2+FO	8.4	46.8	49.8	3480	2100	0.554	0.26	0.34	172	5.01
3x35+2x50/2+FO	8.4	50.3	54.3	4000	2100	0.554	0.26	0.36	172	5.01
3x50+2x25/2+FO	10.1	51.3	55.3	4370	3000	0.386	0.3	0.32	215	7.15
3x50+2x50/2+FO	10.1	51.3	55.3	4450	3000	0.386	0.3	0.32	215	7.15
3x70+2x35/2+FO	11.8	55	59	5370	4200	0.272	0.33	0.31	265	10.01
3x70+2x50/2+FO	11.8	55	59	5480	4200	0.272	0.33	0.31	265	10.01
3x95+2x50/2+FO	13.8	59.2	63.2	6550	5700	0.206	0.37	0.3	319	13.59
3x120+2x70/2+FO	15.5	64.2	68.2	8000	7200	0.161	0.41	0.29	371	17.16
3x150+2x70/2+FO	17.4	68.2	72.2	9240	9000	0.129	0.44	0.28	428	21.45
3x185+2x95/2+FO	19.2	73.4	77.4	11010	11100	0.106	0.48	0.27	488	26.46
3x240+2x120/2+FO	22.1	79.6	83.6	13650	14400	0.0801	0.54	0.26	574	34.32
3x300+2x150/2+FO	24.7	86.4	91.4	16590	18000	0.0641	0.59	0.26	660	42.9

(1) Nominal current carrying capacity for rubber cables laid on a surface, at 30°C ambient temperature (see also VDE 0298-4, Table 15). For derating-factors see tables in Technical Appendix.

Special designs available upon request, e.g.:

- different outer sheath colors
- special types for cold regions (-45°C reeling)
- halogen-free version with 5GM3 outer sheath
- integration of additional control cores in the interstices

Design with 6, 12, 18 or 24 fibers, in G62,5, G50 and E9 available upon request. Further combination with different fiber types is also possible

PROTOLON(M) R-(N)TSCGEW0EU 14/25 kV

Number of cores x cross section	Conductor diameter max. mm	Outer diameter min. mm	Outer diameter max. mm	Weight (approx.) kg/km	Permissible tensile force max. N	Conductor resistance at 20°C max. Ω/km	Nominal operating capacitance μF/km	Inductance nom. mH/km	Current carrying capacity (1) A	Short Circuit Current (conductor) kA
3x25+2x25/2+FO	7.1	47.9	50.9	3360	1500	0.7839	0.2	0.38	139	3.58
3x25+2x50/2+FO	7.1	47.9	50.9	3440	1500	0.7839	0.2	0.4	139	3.58
3x35+2x25/2+FO	8.4	51.5	55.5	4050	2100	0.554	0.22	0.36	172	5.01
3x35+2x50/2+FO	8.4	51.5	55.5	4130	2100	0.554	0.22	0.36	172	5.01
3x50+2x25/2+FO	10.1	55.2	59.2	4830	3000	0.386	0.26	0.34	215	7.15
3x50+2x50/2+FO	10.1	55.2	59.2	4900	3000	0.386	0.26	0.34	215	7.15
3x70+2x35/2+FO	11.8	58.8	62.8	5840	4200	0.272	0.28	0.32	265	10.01
3x70+2x50/2+FO	11.8	58.8	62.8	5950	4200	0.272	0.28	0.32	265	10.01
3x95+2x50/2+FO	13.8	64.4	68.4	7280	5700	0.206	0.31	0.31	319	13.59
3x120+2x70/2+FO	15.5	68	72	8530	7200	0.161	0.35	0.3	371	17.16
3x150+2x70/2+FO	17.4	73.4	77.4	10080	9000	0.129	0.37	0.29	428	21.45
3x185+2x95/2+FO	19.2	77.3	81.3	11630	11100	0.106	0.4	0.28	488	26.46
3x240+2x120/2+FO	22.1	84.7	89.7	14690	14400	0.0801	0.45	0.27	574	34.32
3x300+2x150/2+FO	24.7	90.2	95.2	17310	18000	0.0641	0.5	0.26	660	42.9

PROTOLON(M) R-(N)TSCGEW0EU 18/30 kV

Number of cores x cross section	Conductor diameter max. mm	Outer diameter min. mm	Outer diameter max. mm	Weight (approx.) kg/km	Permissible tensile force max. N	Conductor resistance at 20°C max. Ω/km	Nominal operating capacitance μF/km	Inductance nom. mH/km	Current carrying capacity (1) A	Short Circuit Current (conductor) kA
3x25+2x25/2+FO	7.1	52.2	56.2	3900	1500	0.7839	0.18	0.4	139	3.58
3x25+2x50/2+FO	7.1	52.2	56.2	3980	1500	0.7839	0.18	0.4	139	3.58
3x35+2x25/2+FO	8.4	55	59	4450	2100	0.554	0.2	0.38	172	5.01
3x35+2x50/2+FO	8.4	55	59	4530	2100	0.554	0.2	0.38	172	5.01
3x50+2x25/2+FO	10.1	58.6	62.6	5250	3000	0.386	0.22	0.35	215	7.15
3x50+2x50/2+FO	10.1	58.6	62.6	5320	3000	0.386	0.22	0.35	215	7.15
3x70+2x35/2+FO	11.8	63.6	67.6	6510	4200	0.272	0.25	0.34	265	10.01
3x70+2x50/2+FO	11.8	63.6	67.6	6610	4200	0.272	0.25	0.34	265	10.01
3x95+2x50/2+FO	13.8	67.8	71.8	7770	5700	0.206	0.27	0.33	319	13.59
3x120+2x70/2+FO	15.5	72.8	76.8	9230	7200	0.161	0.29	0.31	371	17.16
3x150+2x70/2+FO	17.4	76.9	80.9	10630	9000	0.129	0.32	0.3	428	21.45
3x185+2x95/2+FO	19.2	80.6	84.6	12190	11100	0.106	0.34	0.3	488	26.46
3x240+2x120/2+FO	22.1	88.1	93.1	15310	14400	0.0801	0.38	0.28	574	34.32
3x300+2x150/2+FO	24.7	94.6	99.6	18220	18000	0.0641	0.42	0.28	660	42.9

(1) Nominal current carrying capacity for rubber cables laid on a surface, at 30°C ambient temperature (see also VDE 0298-4, Table 15). For derating-factors see tables in Technical Appendix.

Special designs available upon request, e.g.:

- different outer sheath colors
- special types for cold regions (-45°C reeling)
- halogen-free version with 5GM3 outer sheath
- integration of additional control cores in the interstices

Design with 6, 12, 18 or 24 fibers, in G62,5, G50 and E9 available upon request. Further combination with different fiber types is also possible

 PROTOLON(M) R-(N)TSCGEW0EU 20/35 kV

Number of cores x cross section	Conductor diameter max. mm	Outer diameter min. mm	Outer diameter max. mm	Weight (approx.) kg/km	Permissible tensile force max. N	Conductor resistance at 20°C max. Ω/km	Nominal operating capacitance μF/km	Inductance nom. mH/km	Current carrying capacity (1) A	Short Circuit Current (conductor) kA
3x25+2x25/2+FO	7.1	56.8	60.8	4450	1500	0.7839	0.16	0.42	139	3.58
3x35+2x25/2+FO	8.4	61.1	65.1	5250	2100	0.554	0.18	0.4	172	5.01
3x50+2x25/2+FO	10.1	64.6	68.6	6080	3000	0.386	0.2	0.37	215	7.15
3x50+2x35/2+FO	10.1	64.6	68.6	6160	3000	0.386	0.2	0.37	215	7.15
3x70+2x35/2+FO	11.8	68.2	72.2	7160	4200	0.272	0.23	0.36	265	10.01

(1) Nominal current carrying capacity for rubber cables laid on a surface, at 30°C ambient temperature (see also VDE 0298-4, Table 15). For derating-factors see tables in Technical Appendix.

Special designs available upon request, e.g.:

- different outer sheath colors
- special types for cold regions (-45°C reeling)
- halogen-free version with 5GM3 outer sheath
- integration of additional control cores in the interstices

Design with 6, 12, 18 or 24 fibers, in G62,5, G50 and E9 available upon request. Further combination with different fiber types is also possible

TENAX-SAS NTSCGEWOU 6 kV – 20 kV

MV cable for trailing applications cold flexible to -50 °C

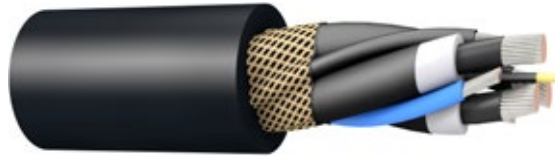

Application

As power supply cable to large mobile equipment in mines. Trailing cable for use with shovels and draglines in trailing and reeling applications. The outer sheath is extremely robust and tough against abrasion and tearing, fully flexible operation down to -50°C,

Global data

Brand	TENAX-SAS
Type designation	NTSCGEWOU
Standard	DIN VDE 0250-813
Certifications / Approvals	Fire Certificate of Russian Federation GOST -R/-K/-B

Design features

Conductor	Tinned copper, finely stranded (class 5), according to DIN VDE 0295
PE-Conductor	Tinned copper, finely stranded (class 5) with semi conductive special rubber compound
Insulation	Rubber, Compound type: EPR 3GI3
Electrical field control	Inner and outer layer of semiconductive rubber compound, cold strippable outer layer
Pilot conductor	Tinned copper, finely stranded (class 5), EPR-Insulation
Core arrangement	Cores laid up around conductive central cradle separator with aramid rope in the centre
Inner sheath	Rubber sheath, Special compound: 5GM3 (mechanical properties)
Outer sheath	Rubber, compound type: better 5GM5, acc. to DIN VDE 0207 part 21; Sheath color: Black

Electrical parameters

Rated voltage	3.6/6 kV	6/10 kV	8.7/15 kV	12/20 kV
Max. permissible operating voltage AC	4.2/7.2 kV	6,9/12 kV	10.4/18 kV	13.9/24 kV
Max. permissible operating voltage DC	5.4/10.8 kV	9/18 kV	13.5/27 kV	18/36 kV
AC test voltage - main cores	11 kV (5 Min.)	17 kV (5 Min.)	24 kV (5 Min.)	29 kV (5 Min.)
AC test voltage - control cores	2 kV	2 kV	2 kV	2 kV

Chemical parameters

Performance against fire	IEC 60322-1-2
Resistance to oil	IEC 60811-404
Weather resistance	Unrestricted use outdoors and indoors, resistant to ozone and moisture
Water resistance	EN 50525-2-21 (HD 22.16)

Thermal parameters

Max. operating temperature of the conductor	90 °C
Max. short circuit temperature of the conductor	250 °C
Ambient temperature for fixed installation	min -50 °C ; max +80 °C
Ambient temperature in fully flexible operation	min -50 °C ; max +60 °C

Mechanical parameters

Max. tensile load on the conductor	25 N/mm ²
Bending radii min.	Acc. to DIN VDE 0298 part 3
Min. distance with S-type directional changes	20 x D

TENAX-SAS NTSCGEW0EU 3.6/6 kV

Number of cores x cross section	Part number	Conductor diameter max. mm	Outer diameter min. mm	Outer diameter max. mm	Weight (approx.) kg/km	Permissible tensile force max. N	Conductor resistance at 20°C max. Ω/km	Nominal operating capacitance μF/km	Inductance nom. mH/km	Current carrying capacity (1) A	Short Circuit Current (conductor) kA
3x16+2x10+10	20095522	5	41	45	2270	1200	1.24	0.2	0.39	99	2.29
3x16+2x16+16		5	40.5	44.5	2469	1200	1.24	0.2	0.39	99	2.29
3x25+2x16+16	20092078	6.2	43.5	47.5	2790	1875	0.795	0.23	0.36	131	3.58
3x35+2x16+16	20076465	7.5	46.5	50	3280	2625	0.565	0.26	0.34	162	5.01
3x50+2x16+16	20114035	9	49.5	54	3900	3750	0.393	0.29	0.32	202	7.15
3x70+2x25+16	20076466	10.6	55	59.5	5020	5250	0.277	0.34	0.3	250	10.01
3x95+2x25+16	20173155	12.6	58.5	63	5860	7125	0.21	0.37	0.29	301	13.59
3x120+2x35+16	20087396	14.8	65.5	70	7410	9000	0.164	0.41	0.28	352	17.16
3x150+2x35+16		16	69.8	73.4	8456	11250	0.132	0.44	0.27	404	21.45
3x185+2x50+16		17.7	72.7	77.2	9955	13875	0.108	0.48	0.27	461	26.46
3x240+2x70+16		20.3	80.1	84.6	12618	18000	0.0817	0.54	0.26	540	34.32
3x300+2x95+16		31.3	84	89	15075	22500	0.0654	0.78	0.24	620	42.9

TENAX-SAS NTSCGEW0EU 6/10 kV

Number of cores x cross section	Part number	Conductor diameter max. mm	Outer diameter min. mm	Outer diameter max. mm	Weight (approx.) kg/km	Permissible tensile force max. N	Conductor resistance at 20°C max. Ω/km	Nominal operating capacitance μF/km	Inductance nom. mH/km	Current carrying capacity (1) A	Short Circuit Current (conductor) kA
3x16+2x16+16		5	42.5	46.5	2613	1200	1.24	0.19	0.4	99	2.29
3x25+2x16+16		6.2	46.1	49.6	3041	1875	0.795	0.21	0.37	131	3.58
3x35+2x16+16	20258100	7.5	52.5	56.5	3470	2625	0.565	0.24	0.35	162	5.01
3x50+2x16+16	20197175	9	52	56.5	4080	3750	0.393	0.27	0.33	202	7.15
3x70+2x25+16	20091980	10.6	57	61.5	5240	5250	0.277	0.31	0.31	250	10.01
3x95+2x25+16		12.6	61.6	66.1	6503	7125	0.21	0.34	0.3	301	13.59
3x120+2x35+16	20117521	14.8	64.2	68.7	7630	9000	0.164	0.38	0.29	352	17.16
3x150+2x35+16		16	70.6	75.1	8694	11250	0.132	0.41	0.28	404	21.45
3x185+2x50+16		17.7	74.4	78.9	10467	13875	0.108	0.44	0.27	461	26.46
3x240+2x70+16		20.3	81.8	86.3	12895	18000	0.0817	0.49	0.26	540	34.32
3x300+2x95+16		31.3	87.5	92.5	15693	22500	0.0654	0.71	0.24	620	42.9

(1) Nominal current carrying capacity for rubber cables laid on a surface, at 30°C ambient temperature (see also VDE 0298-4, Table 15). For derating-factors see tables in Technical Appendix

TENAX-SAS NTSCGEW0EU 8.7/15 kV

Number of cores x cross section	Conductor diameter max. mm	Outer diameter min. mm	Outer diameter max. mm	Weight (approx.) kg/km	Permissible tensile force max. N	Conductor resistance at 20°C max. Ω/km	Nominal operating capacitance μF/km	Inductance nom. mH/km	Current carrying capacity (1) A	Short Circuit Current (conductor) kA
3x16+2x16+16	5	47	51	3041	1200	1.24	0.16	0.43	105	2.29
3x25+2x16+16	6.2	52	56	3677	1875	0.795	0.18	0.4	139	3.58
3x35+2x16+16	7.5	55.4	59.9	4138	2625	0.565	0.2	0.37	172	5.01
3x50+2x16+16	9	57.5	61.5	4813	3750	0.393	0.22	0.35	215	7.15
3x70+2x25+16	10.6	64	68	6159	5250	0.277	0.26	0.33	265	10.01
3x95+2x25+16	12.6	68.2	72.7	7123	7125	0.21	0.28	0.32	319	13.59
3x120+2x35+16	14.8	72.9	77.4	8322	9000	0.164	0.31	0.31	371	17.16
3x150+2x35+16	16	75.4	79.9	9645	11250	0.132	0.33	0.3	428	21.45
3x185+2x50+16	17.7	80.9	85.4	11208	13875	0.108	0.36	0.29	488	26.46
3x240+2x70+16	20.3	86.5	91	13991	18000	0.0817	0.4	0.28	574	34.32
3x300+2x95+16	31.3	92	97	16533	22500	0.0654	0.57	0.25	660	42.9

TENAX-SAS NTSCGEW0EU 12/20 kV

Number of cores x cross section	Part number	Conductor diameter max. mm	Outer diameter min. mm	Outer diameter max. mm	Weight (approx.) kg/km	Permissible tensile force max. N	Conductor resistance at 20°C max. Ω/km	Nominal operating capacitance μF/km	Inductance nom. mH/km	Current carrying capacity (1) A	Short Circuit Current (conductor) kA
3x16+2x16+16		5	53.5	57.5	3655	1200	1.24	0.14	0.45	105	2.29
3x25+2x16+16		6.2	56.9	61.4	4145	1875	0.795	0.16	0.42	139	3.58
3x35+2x16+16		7.5	59.7	64.2	4628	2625	0.565	0.18	0.39	172	5.01
3x50+2x16+16		9	62.8	67.3	5552	3750	0.393	0.2	0.37	215	7.15
3x95+2x25+16		12.6	72.5	77	7727	7125	0.21	0.25	0.33	319	13.59
3x120+2x35+16		14.8	79	83.5	9224	9000	0.164	0.27	0.32	371	17.16
3x150+2x35+16		16	81.5	86	10324	11250	0.132	0.29	0.31	428	21.45
3x185+2x50+16		17.7	85.5	90.5	12218	13875	0.108	0.31	0.3	488	26.46
3x240+2x70+16		20.3	92.6	97.1	14768	18000	0.0817	0.35	0.29	574	34.32
3x300+2x95+16		31.3	98.5	103.5	17694	22500	0.0654	0.49	0.26	660	42.9

(1) Nominal current carrying capacity for rubber cables laid on a surface, at 30°C ambient temperature (see also VDE 0298-4, Table 15). For derating-factors see tables in Technical Appendix

PROTOLON(SB) NTSCGEWOU 6 kV – 20 kV

Medium Voltage flexible trailing cables



Application

As power supply or connection cables for large material handling machines, e.g. excavators in open-cast mines subject to extremely high mechanical stresses in which abrasion and chaffing stresses are to be expected in trailing operation.

Global data

Brand	PROTOLON(SB)
Type designation	NTSCGEWOU
Standard	DIN VDE 0250-813
Certifications / Approvals	Fire Certificate of Russian Federation GOST -R/-K/-B MSHA P-189-4

Design features

Conductor	Electrolytic copper, tinned, finely stranded (class 5)
PE-Conductor	Electrolytic copper, tinned, very finely stranded (class FS)
Insulation	basic material EPR, compound type 3GI3
Electrical field control	Inner and outer layer of semiconductive rubber compound
Core identification	Natural colored with black semi conductive rubber and white numbers (1-3)
Core arrangement	Three-core design, with split earth conductor in the interstices
Inner sheath	Special chloroprene rubber compound, type 5GM5. Color: natural
Torsion protection	Extremely tear-resistant reinforcing tape which prevents sheath movement
Outer sheath	Special extremely abrasion-resistant and tearproof chloroprene rubber compound, bonded to inner sheath, type 5GM5. Color: black (other colors available upon request)

Electrical parameters

Rated voltage	3.6/6 kV	6/10 kV	8.7/15 kV	12/20 kV
Max. permissible operating voltage AC	4.2/7.2 kV	6,9/12 kV	10.4/18 kV	13.9/24 kV
Max. permissible operating voltage DC	5.4/10.8 kV	9/18 kV	13.5/27 kV	18/36 kV
AC test voltage - main cores	11 kV (5 Min.)	17 kV (5 Min.)	24 kV (5 Min.)	29 kV (5 Min.)
AC test voltage - control cores	2 kV	2 kV	2 kV	2 kV

Chemical parameters

Performance against fire	IEC 60322-1-2
Resistance to oil	IEC 60811-2-1
Weather resistance	Unrestricted use outdoors and indoors, resistant to ozone, UV and moisture
Water resistance	EN 50525-2-21 (HD 22.16)

Thermal parameters

Max. operating temperature of the conductor	90 °C
Max. short circuit temperature of the conductor	250 °C
Ambient temperature for fixed installation	min -40 °C ; max +80 °C
Ambient temperature in fully flexible operation	min -20 °C ; max +60 °C

Mechanical parameters

Max. tensile load on the conductor	15 N/mm ²
Torsional stress +/-	100 %/m
Bending radii min.	Acc. to DIN VDE 0298 part 3

PROTOLON(SB) NTSCGEWOU 3.6/6 kV

Number of cores x cross section	Part number	MLFB Number	Conductor diameter max. mm	Outer diameter min. mm	Outer diameter max. mm	Weight (approx.) kg/km	Permissible tensile force max. N	Conductor resistance at 20°C max. Ω/km	Nominal operating capacitance μF/km	Inductance nom. mH/km	Current carrying capacity (1) A	Short Circuit Current (conductor) kA
3x25+3x25/3	20141997	5DK3239	6.4	43.1	46.1	2910	1125	0.795	0.34	0.36	131	3.58
3x35+3x25/3	20004488	5DK3241	7.6	42.5	45.5	3180	1575	0.565	0.39	0.34	162	5.01
3x50+3x25/3	20004489	5DK3243	9.1	45.7	48.7	3860	2250	0.393	0.43	0.32	202	7.15
3x70+3x35/3	20007566	5DK3244	10.9	51.7	55.7	5080	3150	0.277	0.49	0.3	250	10.01
3x95+3x50/3	20196345	5DK3***	12.6	59.9	63.9	6580	4275	0.21	0.54	0.29	301	13.59
3x120+3x70/3	20141998	5DK3***	14.2	59	63	8110	5400	0.164	0.6	0.28	352	17.16
3x150+3x70/3			15.9	64.4	68.4	8610	6750	0.132	0.65	0.27	404	21.45
3x185+3x95/3			17.7	68.3	72.3	10020	8325	0.108	0.7	0.27	461	26.46

PROTOLON(SB) NTSCGEWOU 6/10 kV

Number of cores x cross section	Part number	MLFB Number	Conductor diameter max. mm	Outer diameter min. mm	Outer diameter max. mm	Weight (approx.) kg/km	Permissible tensile force max. N	Conductor resistance at 20°C max. Ω/km	Nominal operating capacitance μF/km	Inductance nom. mH/km	Current carrying capacity (1) A	Short Circuit Current (conductor) kA
3x25+3x25/3	20004569	5DK4159	6.4	41.6	44.6	2880	1125	0.795	0.31	0.37	131	3.58
3x35+3x25/3	20042608	5DK4160	7.6	44.2	47.2	3340	1575	0.565	0.35	0.34	162	5.01
3x50+3x25/3	20007120	5DK4148	9.1	47.3	50.3	4020	2250	0.393	0.39	0.33	202	7.15
3x70+3x35/3	20214092	5DK4743	10.9	53.4	57.4	5610	3150	0.277	0.44	0.31	250	10.01
3x95+3x50/3			12.6	57.4	61.4	6140	4275	0.21	0.49	0.3	301	13.59
3x120+3x70/3	20001445	5DK4151	14.2	62.6	66.6	8010	5400	0.164	0.54	0.29	352	17.16
3x150+3x70/3	20001444	5DK4147	15.9	66.1	70.1	9170	6750	0.132	0.58	0.28	404	21.45
3x185+3x95/3	20161680		17.7	69.6	73.6	10280	8325	0.108	0.63	0.27	461	26.46

(1) Nominal current carrying capacity for rubber cables laid on a surface, at 30°C ambient temperature (see also VDE 0298-4, Table 15). For derating-factors see tables in Technical Appendix.

Special designs available upon request, e.g.:

- with metallic screen over main cores (type designation: NTSCGEWOU)
- up to 3x70... with 50/3 earth conductor for applications according to DIN VDE 0168
- different outer sheath colors
- special types for cold regions (-45°C)
- integration of additional control cores or pilots in the interstices

PROTOLON(SB) NTSCGEWOU 8.7/15 kV

Number of cores x cross section	Part number	MLFB Number	Conductor diameter max. mm	Outer diameter min. mm	Outer diameter max. mm	Weight (approx.) kg/km	Permissible tensile force max. N	Conductor resistance at 20°C max. Ω/km	Nominal operating capacitance μF/km	Inductance nom. mH/km	Current carrying capacity (1) A	Short Circuit Current (conductor) kA
3x25+3x25/3			6.4	46.3	49.3	3230	1125	0.795	0.25	0.39	139	3.58
3x35+3x25/3			7.6	50.2	54.2	3920	1575	0.565	0.28	0.37	172	5.01
3x50+3x25/3			9.1	53.3	57.3	4610	2250	0.393	0.31	0.35	215	7.15
3x70+3x35/3	20271483	5DK5***	10.9	58	62	6000	3150	0.277	0.35	0.33	265	10.01
3x95+3x50/3	20111952	5DK5***	12.6	68.2	72.2	7850	4275	0.21	0.39	0.32	319	13.59
3x120+3x70/3			14.2	67.2	71.2	8440	5400	0.164	0.42	0.031	371	17.16
3x150+3x70/3			15.9	70.8	74.8	9640	6750	0.132	0.46	0.3	428	21.45
3x185+3x95/3			17.7	76.4	80.4	11440	8325	0.108	0.5	0.29	488	26.46

PROTOLON(SB) NTSCGEWOU 12/20 kV

Number of cores x cross section	Part number	MLFB Number	Conductor diameter max. mm	Outer diameter min. mm	Outer diameter max. mm	Weight (approx.) kg/km	Permissible tensile force max. N	Conductor resistance at 20°C max. Ω/km	Nominal operating capacitance μF/km	Inductance nom. mH/km	Current carrying capacity (1) A	Short Circuit Current (conductor) kA
3x25+3x25/3	20231823	5DK5***	6.4	51.9	55.9	3920	1125	0.795	0.22	0.41	139	3.58
3x35+3x25/3	20004723	5DK5743	7.6	54.4	58.4	4450	1575	0.565	0.25	0.39	172	5.01
3x50+3x25/3	20227351	5DK5***	9.1	65	69	6300	2250	0.393	0.27	0.37	215	7.15
3x70+3x35/3	20165211	5DK5***	10.9	68.9	72.9	7410	3150	0.277	0.3	0.35	265	10.01
3x95+3x50/3			12.6	68.1	72.1	7950	4275	0.21	0.33	0.33	319	13.59
3x120+3x70/3			14.2	71.4	75.4	9160	5400	0.164	0.36	0.32	371	17.16
3x150+3x70/3			15.9	76.8	80.8	10720	6750	0.132	0.39	0.31	428	21.45
3x185+3x95/3	20227352	5DK5***	17.7	88.4	92.4	13530	8325	0.108	0.42	0.3	488	26.46

(1) Nominal current carrying capacity for rubber cables laid on a surface, at 30°C ambient temperature (see also VDE 0298-4, Table 15). For derating-factors see tables in Technical Appendix.

Special designs available upon request, e.g.:

- with metallic screen over main cores (type designation: NTSCGEWOU)
- up to 3x70... with 50/3 earth conductor for applications according to DIN VDE 0168
- different outer sheath colors
- special types for cold regions (-45°C)
- integration of additional control cores or pilots in the interstices

PROTOLON(SB-SAM) (N)TSCGEWUEU 6 kV – 20 kV

Medium Voltage flexible trailing cable with optimized wall-thickness



Application

As power supply or connection cables for large material handling machines, e.g. excavators in opencast mines subject to extremely high mechanical stresses in which abrasion and chaffing stresses are to be expected in trailing operation.

Global data

Brand	PROTOLON(SB-SAM)
Type designation	(N)TSCGEWUEU
Standard	Based on DIN VDE 0250-813
Certifications / Approvals	Fire Certificate of Russian Federation GOST -R/-K/-B

Design features

Conductor	Bare electrolytic copper, finely stranded (class 5)
PE-Conductor	Bare electrolytic copper, very finely stranded (class FS)
Insulation	PROTOLON, Basic material: EPR, Compound type: Special compound, better 3G13
Electrical field control	Inner and outer layer of semiconductive rubber compound
Core identification	Natural coloring with black semiconductive rubber on which white digits 1 to 3 are printed
Pilot conductor	EPR insulated copper conductor (class FS), Color: Yellow
Core arrangement	Three-core design, with split earth conductor and pilot in the interstices
Inner sheath	Special chloroprene rubber compound, type 5GM5. Color: natural
Torsion protection	Extremely tear-resistant reinforcing tape, which prevents sheath movement
Outer sheath	Special extremely abrasion-resistant and tearproof chloroprene rubber compound, bonded to inner sheath, type 5GM5. Color: black (other colors available upon request)

Electrical parameters

Rated voltage	3.6/6 kV	6/10 kV	8.7/15 kV	12/20 kV
Max. permissible operating voltage AC	4.2/7.2 kV	6,9/12 kV	10.4/18 kV	13.9/24 kV
Max. permissible operating voltage DC	5.4/10.8 kV	9/18 kV	13.5/27 kV	18/36 kV
AC test voltage	11 kV	17 kV	24 kV	29 kV
AC test voltage - control cores	2 kV	2 kV	2 kV	2 kV

Chemical parameters

Performance against fire	IEC 60332-1-2
Resistance to oil	IEC 60811-404
Weather resistance	Unrestricted use outdoors and indoors, resistant to ozone, UV and moisture
Water resistance	HD 22.16 (EN 50525-2-21)

Thermal parameters

Max. operating temperature of the conductor	90 °C
Max. short circuit temperature of the conductor	250 °C
Ambient temperature for fixed installation	min -40 °C ; max +80 °C
Ambient temperature in fully flexible operation	min -30 °C ; max +60 °C

Mechanical parameters

Max. tensile load on the conductor	20 N/mm ²
Torsional stress +/-	100 °/m
Bending radii min.	Acc. to DIN VDE 0298 part 3

PROTOLON(SB-SAM) (N)TSCGEWOU 3.6/6 kV

Number of cores x cross section	Part number	MLFB Number	Conductor diameter max. mm	Outer diameter min. mm	Outer diameter max. mm	Weight (approx.) kg/km	Permissible tensile force max. N	Conductor resistance at 20°C max. Ω/km	Nominal operating capacitance μF/km	Inductance nom. mH/km	Current carrying capacity (1) A	Short Circuit Current (conductor) kA
3x25+2x25/2 + 1x10ST	20203078	5DK3246	6.5	35.5	42.5	2670	1500	0.78	0.35	0.32	131	3.58
3x35+2x25/2 + 1x10ST	20181804	5DK3249	7.6	41.9	44.9	3020	2100	0.554	0.39	0.31	162	5.01
3x50+2x25/2 + 1x10ST	20183832	5DK3***	9.1	42.8	45.8	3510	3000	0.386	0.45	0.29	202	7.15
3x70+2x35/2 + 1x10ST			10.9	46.5	49.5	4300	4200	0.272	0.52	0.28	250	10.01
3x95+2x50/2 + 1x10ST			12.7	52.9	56.9	5600	5700	0.206	0.58	0.27	301	13.59
3x120+2x70/2 + 1x10ST			14.4	56.5	60.5	6750	7200	0.161	0.65	0.26	352	17.16
3x150+2x70/2 + 1x10ST			16.2	63	67	8100	9000	0.129	0.71	0.25	404	21.45
3x185+2x95/2 + 1x10ST			17.8	66.4	70.4	9400	11100	0.106	0.77	0.25	461	26.46
3x240+2x120/2 + 1x10ST			20.6	72.3	76.3	11700	14400	0.08	0.88	0.24	540	34.32

PROTOLON(SB-SAM) (N)TSCGEWOU 6/10 kV

Number of cores x cross section	Part number	MLFB Number	Conductor diameter max. mm	Outer diameter min. mm	Outer diameter max. mm	Weight (approx.) kg/km	Permissible tensile force max. N	Conductor resistance at 20°C max. Ω/km	Nominal operating capacitance μF/km	Inductance nom. mH/km	Current carrying capacity (1) A	Short Circuit Current (conductor) kA
3x25+2x25/2 + 1x10ST			6.5	40.8	43.8	2700	1500	0.78	0.3	0.34	131	3.58
3x35+2x25/2 + 1x10ST	20036708	5DK4548	7.6	41.1	44.1	3030	2100	0.554	0.33	0.32	162	5.01
3x50+2x25/2 + 1x10ST			9.1	45.3	48.3	3600	3000	0.386	0.38	0.31	202	7.15
3x70+2x35/2 + 1x10ST	20079290	5DK4459	10.9	47.7	50.7	4540	4200	0.272	0.43	0.29	250	10.01
3x95+2x50/2 + 1x10ST			12.7	54.2	58.2	5700	5700	0.206	0.48	0.28	301	13.59
3x120+2x70/2 + 1x10ST	20006948	5DK4243	14.4	57.7	61.7	7130	7200	0.161	0.54	0.27	352	17.16
3x150+2x70/2 + 1x10ST			16.2	64.2	68.2	8300	9000	0.129	0.59	0.26	404	21.45
3x185+2x95/2 + 1x10ST			17.8	67.6	71.6	9600	11100	0.106	0.64	0.26	461	26.46
3x240+2x120/2 + 1x10ST	20008103	5DK4246	20.6	72.3	76.3	12060	14400	0.08	0.72	0.25	540	34.32

(1) Nominal current carrying capacity for rubber cables laid on a surface, at 30°C ambient temperature (see also VDE 0298-4, Table 15).

For derating-factors see tables in Technical Appendix

Special designs available upon request, e.g.:

- with metallic screen over main cores (type designation: (N)TSCGECEWOU)
- different outer sheath colors
- special types for cold regions (-45°C)
- integration of additional control cores or pilots in the interstices

PROTOLON(SB-SAM) (N)TSCGEW0EU 8.7/15 kV

Number of cores x cross section	Part number	MLFB Number	Conductor diameter max. mm	Outer diameter min. mm	Outer diameter max. mm	Weight (approx.) kg/km	Permissible tensile force max. N	Conductor resistance at 20°C max. Ω/km	Nominal operating capacitance μF/km	Inductance nom. mH/km	Current carrying capacity (1) A	Short Circuit Current (conductor) kA
3x25+2x25/2 + 1x10ST			6.5	41.9	44.9	2600	1500	0.78	0.22	0.37	139	3.58
3x35+2x25/2 + 1x10ST	20069641	5DK5412	7.6	45.5	48.5	3440	2100	0.554	0.25	0.35	172	5.01
3x50+2x25/2 + 1x10ST			9.1	47.4	50.4	3700	3000	0.386	0.28	0.33	215	7.15
3x70+2x35/2 + 1x10ST	20069640	5DK5414	10.9	53.7	57.7	5380	4200	0.272	0.32	0.31	265	10.01
3x95+2x50/2 + 1x10ST			12.7	57.6	61.6	6150	5700	0.206	0.35	0.3	319	13.59
3x120+2x70/2 + 1x10ST	20088941	5DK5416	14.4	63	67	7840	7200	0.161	0.39	0.29	371	17.16
3x150+2x70/2 + 1x10ST	20088942	5DK5417	16.2	66.8	70.8	8990	9000	0.129	0.43	0.28	428	21.45
3x185+2x95/2 + 1x10ST			17.8	71	75	10100	11100	0.106	0.46	0.27	488	26.46
3x240+2x120/2 + 1x10ST	20216531	5DK5***	20.6	78.3	83.3	12800	14400	0.08	0.52	0.27	574	34.32

PROTOLON(SB-SAM) (N)TSCGEW0EU 12/20 kV

Number of cores x cross section	Part number	MLFB Number	Conductor diameter max. mm	Outer diameter min. mm	Outer diameter max. mm	Weight (approx.) kg/km	Permissible tensile force max. N	Conductor resistance at 20°C max. Ω/km	Nominal operating capacitance μF/km	Inductance nom. mH/km	Current carrying capacity (1) A	Short Circuit Current (conductor) kA
3x25+2x25/2 + 1x10ST			6.5	44.9	47.9	3000	1500	0.78	0.22	0.37	139	3.58
3x35+2x25/2 + 1x10ST	20203799	5DK6***	7.6	47.2	50.2	3500	2100	0.554	0.24	0.35	172	5.01
3x50+2x25/2 + 1x10ST			9.1	51.7	55.7	4350	3000	0.386	0.27	0.33	215	7.15
3x70+2x35/2 + 1x10ST			10.9	55.5	59.5	5400	4200	0.272	0.31	0.32	265	10.01
3x95+2x50/2 + 1x10ST			12.7	60.5	64.5	6500	5700	0.206	0.35	0.3	319	13.59
3x120+2x70/2 + 1x10ST			14.4	65.9	69.9	8000	7200	0.161	0.38	0.29	371	17.16
3x150+2x70/2 + 1x10ST			16.2	70.6	74.6	9200	9000	0.129	0.42	0.28	428	21.45
3x185+2x95/2 + 1x10ST			17.8	75.8	79.8	10850	11100	0.106	0.45	0.28	488	26.46
3x240+2x120/2 + 1x10ST			20.6	81.2	86.2	13300	14400	0.08	0.51	0.27	574	34.32

(1) Nominal current carrying capacity for rubber cables laid on a surface, at 30°C ambient temperature (see also VDE 0298-4, Table 15).

For derating-factors see tables in Technical Appendix

Special designs available upon request, e.g.:

- with metallic screen over main cores (type designation: (N)TSCGECEW0EU)
- different outer sheath colors
- special types for cold regions (-45°C)
- integration of additional control cores or pilots in the interstices

TENAX-LUMEN (N)TSCGEH3S 6 kV – 10 kV

Luminescent power cable for trailing application



Application

The TENAX-LUMEN is intended as trailing cable for the power supply to large mobile equipment in mines, such as shovels and draglines. Especially intended for application where, to guarantee the safety of personnel and equipment, the cable must be visible in the dark. The outer sheath is extremely robust and tough against abrasion and tearing, suitable for fully flexible operation down to -50°C.

Global data

Brand	TENAX-LUMEN
Type designation	(N)TSCGEH3S
Standard	Based on DIN VDE 0250-813
Certifications / Approvals	in preparation

Design features

Conductor	Tinned copper, finely stranded (claas 5), according to IEC 60228 / DIN VDE 0295
PE-Conductor	Tinned copper, finely stranded (claas 5) with semi conductive special rubber compound
Insulation	Rubber, compound type EPR 3GI3
Electrical field control	Inner and outer layer of semiconductive rubber compound, cold strippable outer layer
Pilot conductor	Tinned copper, finely stranded (claas 5), EPR-Insulation
Illuminating element	Special electroluminescent string designed for high visibility and low power consumption
Core arrangement	Cores laid up around semiconductive central filler with armid yarns
Outer sheath	PUR compound, transparent
Outer sheath colour	Orange

Electrical parameters

Rated voltage	3.6/6 kV	6/10 kV
Max. permissible operating voltage AC	4.2/7.2 kV	6,9/12 kV
Max. permissible operating voltage DC	5,4/10,8 kV	9/18 kV
AC test voltage - main cores	11 kV (5 Min.)	17 kV (5 Min.)
Luminescent voltage max.	125 V AC	125 V AC
Luminescent frequency max.	2000 Hz	2000 Hz
Luminescent current absorption	~ 15 A/km	~ 15 A/km
Luminescent heat development	none	none
Luminescent light homogeneity	> 95%	> 95%
Luminescent irradiation	360°	360°

Chemical parameters

Performance against fire	EN 60332-1-2; IEC 60332-1-2
Resistance to oil	EN 60811-404; IEC 60811-404
Weather resistance	Unrestricted use outdoors, resistant to ozone and moisture

Thermal parameters

Max. operating temperature of the conductor	90 °C
Max. short circuit temperature of the conductor	250 °C
Ambient temperature for fixed installation	min -50°C; max +80°C
Ambient temperature in fully flexible operation	min -50°C; max +60°C

Mechanical parameters

Max. tensile load on the conductor	25 N/mm ²
Bending radii min.	Acc. to DIN VDE 0298 part 3
Min. distance with S-type directional changes	20 x OD

TENAX-LUMEN (N)TSCGEH3S 3.6/6 kV

Number of cores x cross section	Conductor diameter max. mm	Outer diameter min. mm	Outer diameter max. mm	Bending radius free moving min. mm	Weight (approx.) kg/km	Permissible tensile force max. N	Conductor resistance at 20°C max. Ω/km	Inductance nom. mH/km	Current carrying capacity (1) A	Short Circuit Current (conductor) kA
3x35+2x16+16	7.5	46.2	49.7	746	3200	2625	0.565	0.34	162	5.01
3x50+2x16+16	9	49.3	53.8	807	3800	3750	0.393	0.32	202	7.15
3x70+2x25+16	10.6	54.6	59.1	887	4900	5250	0.277	0.3	250	10.01
3x95+2x25+16	12.6	58.9	63.4	951	5750	7125	0.21	0.29	301	13.59
3x120+2x35+16	14.8	65.5	70	1050	7250	9000	0.164	0.28	352	17.16
3x150+2x35+16	16	68.8	72.4	1086	8350	11250	0.132	0.27	404	21.45
3x185+2x50+16	17.7	71.7	76.2	1143	9850	13875	0.108	0.27	461	26.46
3x240+2x70+16	20.3	79.1	83.6	1254	12500	18000	0.0817	0.26	540	34.32

TENAX-LUMEN (N)TSCGEH3S 6/10 kV

Number of cores x cross section	Conductor diameter max. mm	Outer diameter min. mm	Outer diameter max. mm	Bending radius free moving min. mm	Weight (approx.) kg/km	Permissible tensile force max. N	Conductor resistance at 20°C max. Ω/km	Inductance nom. mH/km	Current carrying capacity (1) A	Short Circuit Current (conductor) kA
3x35+2x16+16	7.5	51	55.5	833	3465	2625	0.565	0.35	162	5.01
3x50+2x16+16	9	52	56	840	4280	3750	0.393	0.33	202	7.15
3x70+2x25+16	10.6	56.3	60.8	912	5360	5250	0.277	0.31	250	10.01
3x95+2x25+16	12.6	60.6	65.1	977	6495	7125	0.21	0.3	301	13.59
3x120+2x35+16	14.8	67.2	71.7	1076	7660	9000	0.164	0.29	352	17.16
3x150+2x35+16	16	69.6	74.1	1112	8685	11250	0.132	0.28	404	21.45
3x185+2x50+16	17.7	73.4	77.9	1169	10460	13875	0.108	0.27	461	26.46
3x240+2x70+16	20.3	80.8	85.3	1280	12890	18000	0.0817	0.26	540	34.32

(1) Nominal current carrying capacity for rubber cables laid on a surface, at 30°C ambient temperature (see also VDE 0298-4, Table 15). For derating-factors see tables in Technical Appendix

PROTOLON(ST) .../3E NTSCGEWUEU 3 kV – 30 kV

Medium voltage flexible cables for use in water with copper core shield



Application

Power supply cable for use in water, e.g. for connection to dredgers, floating docks, pumps, etc., in applications where high mechanical stresses are to be expected. Also suitable for use in sewage, salt water and brackish water at water depths of up to 500 m. This screened cable design is suitable for the use with dredging equipment acc. VDE 0168.

Global data

Brand	PROTOLON(ST)
Type designation	NTSCGEWUEU
Standard	DIN VDE 0250-813
Certifications / Approvals	MSHA P-189-4 Fire Certificate of Russian Federation GOST -R/-K/-B

Design features

Conductor	Electrolytic copper, tinned, finely stranded (class 5)
Insulation	Basic material EPR, Compound type: 3GI3
Electrical field control	Inner and outer layer of semiconductive rubber compound and metallic concentric screen on each core
Core identification	Natural coloring with black semiconductive rubber
Core arrangement	Three main conductor laid-up with individual concentric protective-earth conductors distributed over the insulation of the three main cores
Inner sheath	EPR inner sheath with special water-proof characteristics for prevention of formation of water bubbles, Compound type: GM1B
Outer sheath	Basic material: synthetic elastomer compound e.g. CM (particularly water-proof), Compound type: 5GM3, Color: Red

Electrical parameters

Rated voltage	1.8/3 kV	3.6/6 kV	6/10 kV	8.7/15 kV
Max. permissible operating voltage AC	2.1/3.6 kV	4.2/7.2 kV	6.9/12 kV	10.4/18 kV
Max. permissible operating voltage DC	2.7/5.4 kV	5.4/10.8 kV	9/18 kV	13.5/27 kV
AC test voltage - main cores	6 kV (5 Min.)	11 kV (5 Min.)	17 kV (5 Min.)	24 kV (5 Min.)
	12/20 kV	14/25 kV	18/30 kV	
	13.9/24 kV	17.3/30 kV	20.8/36 kV	
	18/36 kV	22.5/45 kV	27/54 kV	
	29 kV (5 Min.)	36 kV (5 Min.)	43 kV (5 Min.)	

Chemical parameters

Performance against fire	IEC 60332-1-2
Resistance to oil	IEC 60811-404
Weather resistance	Unrestricted use outdoors and indoors, resistant to ozone, UV and moisture
Water resistance	EN50525-2-21

Thermal parameters

Max. operating temperature of the conductor	90 °C
Max. short circuit temperature of the conductor	250 °C
Ambient temperature for fixed installation	min -40 °C ; max +80 °C
Ambient temperature in fully flexible operation	min -25 °C ; max +60 °C

Mechanical parameters

Max. tensile load on the conductor	15 N/mm ²
Torsional stress +/-	25 °/m
Bending radii min.	Acc. to DIN VDE 0298 part 3

PROTOLON(ST) .../3E NTSCGEW0EU 1.8/3 kV

Number of cores x cross section	Part number	MLFB Number	Conductor diameter max. mm	Outer diameter min. mm	Outer diameter max. mm	Weight (approx.) kg/km	Permissible tensile force max. N	Conductor resistance at 20°C max. Ω/km	Nominal operating capacitance μF/km	Inductance nom. mH/km	Current carrying capacity (1) A	Short Circuit Current (conductor) kA
3x25+3x25/3E			6.4	37.5	40.5	2400	1125	0.795	0.33	0.33	131	3.58
3x35+3x25/3E			7.6	40.9	43.9	3000	1575	0.565	0.38	0.31	162	5.01
3x50+3x25/3E	20218322	5DK2***	9	45.4	48.4	3600	2250	0.393	0.43	0.3	202	7.15
3x70+3x35/3E	20218323	5DK2***	10.9	50.8	54.8	4800	3150	0.277	0.5	0.28	250	10.01
3x95+3x50/3E			12.6	57.1	61.1	6200	4275	0.21	0.52	0.27	301	13.59
3x120+3x70/3E	20008063	5DK2435	14.1	59.7	63.7	7540	5400	0.164	0.56	0.27	352	17.16
3x150+3x70/3E			16	67.6	71.6	8700	6750	0.132	0.63	0.26	404	21.45
3x185+3x95/3E	20161198	5DK2***	17.8	69.3	73.3	10160	8325	0.108	0.69	0.25	461	26.46

PROTOLON(ST) .../3E NTSCGEW0EU 3.6/6 kV

Number of cores x cross section	Part number	MLFB Number	Conductor diameter max. mm	Outer diameter min. mm	Outer diameter max. mm	Weight (approx.) kg/km	Permissible tensile force max. N	Conductor resistance at 20°C max. Ω/km	Nominal operating capacitance μF/km	Inductance nom. mH/km	Current carrying capacity (1) A	Short Circuit Current (conductor) kA
3x16+3x16/3E	20004508	5DK3779	5.7	37.5	40.5	2250	720	1.24	0.24	0.35	99	2.29
3x25+3x25/3E	20233752	5DK3***	6.4	42.4	45.4	2800	1125	0.795	0.26	0.35	131	3.58
3x35+3x16/3E	20004509	5DK3782	7.6	43.9	46.9	3310	1575	0.565	0.29	0.33	162	5.01
3x35+3x25/3E	20004510	5DK3783	7.6	44.3	47.3	3420	1575	0.565	0.29	0.33	162	5.01
3x50+3x25/3E	20004511	5DK3784	9	48.1	51.1	4160	2250	0.393	0.33	0.32	202	7.15
3x70+3x35/3E	20004512	5DK3786	10.9	54.3	58.3	5440	3150	0.277	0.38	0.3	250	10.01
3x95+3x50/3E	20165442	5DK3787	12.6	63.8	67.8	6610	4275	0.21	0.43	0.29	301	13.59
3x120+3x70/3E	20061120	5DK3785	14.1	64	68	8240	5400	0.164	0.47	0.28	352	17.16
3x150+3x70/3E	20160411	5DK3778	16	69.9	73.9	9520	6750	0.132	0.52	0.27	404	21.45
3x185+3x95/3E			17.8	75.8	79.8	11000	8325	0.108	0.56	0.26	461	26.46

PROTOLON(ST) .../3E NTSCGEW0EU 6/10 kV

Number of cores x cross section	Part number	MLFB Number	Conductor diameter max. mm	Outer diameter min. mm	Outer diameter max. mm	Weight (approx.) kg/km	Permissible tensile force max. N	Conductor resistance at 20°C max. Ω/km	Nominal operating capacitance μF/km	Inductance nom. mH/km	Current carrying capacity (1) A	Short Circuit Current (conductor) kA
3x25+3x16/3E	20007441	5DK4300	6.4	43.9	46.9	3100	1125	0.795	0.24	0.36	131	3.58
3x25+3x25/3E			6.4	44.1	47.1	3100	1125	0.795	0.24	0.36	131	3.58
3x35+3x16/3E	20004604	5DK4301	7.6	49.8	52.8	3850	1575	0.565	0.27	0.34	162	5.01
3x35+3x25/3E	20230975	5DK4893	7.6	46.7	49.7	3740	1575	0.565	0.27	0.34	162	5.01
3x50+3x25/3E	20004597	5DK4206	9	52.4	56.4	4460	2250	0.393	0.3	0.32	202	7.15
3x70+3x35/3E	20004598	5DK4207	10.9	57.3	61.3	5840	3150	0.277	0.34	0.31	250	10.01
3x95+3x50/3E	20035932	5DK4209	12.6	63.2	67.2	7250	4275	0.21	0.38	0.29	301	13.59
3x120+3x70/3E	20164605	5DK4897	14.1	67.1	71.1	8560	5400	0.164	0.42	0.29	352	17.16
3x150+3x70/3E			16	71.9	75.9	9400	6750	0.132	0.46	0.28	404	21.45
3x185+3x95/3E			17.8	77.6	81.6	11300	8325	0.108	0.5	0.27	461	26.46

(1) Nominal current carrying capacity for rubber cables laid on a surface, at 30°C ambient temperature (see also VDE 0298-4, Table 15). For derating-factors see tables in Technical Appendix
Special designs with control-cores and fiber optics available on request

PROTOLON(ST) .../3E NTSCGEW0EU 8.7/15 kV

Number of cores x cross section	Conductor diameter max. mm	Outer diameter min. mm	Outer diameter max. mm	Weight (approx.) kg/km	Permissible tensile force max. N	Conductor resistance at 20°C max. Ω/km	Nominal operating capacitance μF/km	Inductance nom. mH/km	Current carrying capacity (1) A	Short Circuit Current (conductor) kA
3x25+3x25/3E	6.4	48.4	52.4	3700	1125	0.795	0.2	0.39	139	3.58
3x35+3x25/3E	7.6	52.8	56.8	4300	1575	0.565	0.22	0.37	172	5.01
3x50+3x25/3E	9	56.6	60.6	5000	2250	0.393	0.24	0.35	215	7.15
3x70+3x35/3E	10.9	60.8	64.8	6300	3150	0.277	0.28	0.33	265	10.01
3x95+3x50/3E	12.6	68	72	7700	4275	0.21	0.31	0.31	319	13.59
3x120+3x70/3E	14.1	71.7	75.7	8950	5400	0.164	0.33	0.3	371	17.16
3x150+3x70/3E	16	77.9	82.9	10500	6750	0.132	0.37	0.29	428	21.45
3x185+3x95/3E	17.8	81.8	86.8	12100	8325	0.108	0.4	0.28	488	26.46

PROTOLON(ST) .../3E NTSCGEW0EU 12/20 kV

Number of cores x cross section	Part number	MLFB Number	Conductor diameter max. mm	Outer diameter min. mm	Outer diameter max. mm	Weight (approx.) kg/km	Permissible tensile force max. N	Conductor resistance at 20°C max. Ω/km	Nominal operating capacitance μF/km	Inductance nom. mH/km	Current carrying capacity (1) A	Short Circuit Current (conductor) kA
3x25+3x16/3E	20004727	5DK5834	6.4	55.3	59.3	4580	1125	0.795	0.17	0.41	139	3.58
3x35+3x16/3E	20001449	5DK5760	7.6	56.6	60.6	4940	1575	0.565	0.19	0.39	172	5.01
3x25+3x25/3E			6.4	55.3	59.3	4350	1125	0.795	0.17	0.41	139	3.58
3x35+3x25/3E	20167511	5DK5***	7.6	57	61	4930	1575	0.565	0.19	0.39	172	5.01
3x50+3x25/3E	20087015	5DK5764	9	59.9	63.9	5790	2250	0.393	0.21	0.37	215	7.15
3x70+3x35/3E	20170540	5DK5763	10.9	67.1	71.1	7090	3150	0.277	0.24	0.35	265	10.01
3x95+3x50/3E	20137463	5DK5***	12.6	71	75	8280	4275	0.21	0.26	0.33	319	13.59
3x120+3x70/3E			14.1	77.8	81.8	10000	5400	0.164	0.28	0.32	371	17.16
3x150+3x70/3E			16	82.3	87.3	11400	6750	0.132	0.31	0.31	428	21.45
3x185+3x95/3E			17.8	87.9	92.9	13300	8325	0.108	0.34	0.3	488	26.46

PROTOLON(ST) .../3E NTSCGEW0EU 14/25 kV

Number of cores x cross section	Part number	MLFB Number	Conductor diameter max. mm	Outer diameter min. mm	Outer diameter max. mm	Weight (approx.) kg/km	Permissible tensile force max. N	Conductor resistance at 20°C max. Ω/km	Nominal operating capacitance μF/km	Inductance nom. mH/km	Current carrying capacity (1) A	Short Circuit Current (conductor) kA
3x25+3x25/3E	20008730	5DK6231	6.4	63	67	5790	1125	0.795	0.15	0.44	139	3.58
3x35+3x25/3E			7.6	64.5	68.5	5900	1575	0.565	0.16	0.41	172	5.01
3x50+3x25/3E	20235304	5DK6***	9	68.4	72.4	6700	2250	0.393	0.18	0.39	215	7.15
3x70+3x35/3E			10.9	72.5	76.5	8000	3150	0.277	0.2	0.37	265	10.01
3x95+3x50/3E			12.6	79.2	84.2	9700	4275	0.21	0.22	0.35	319	13.59
3x120+3x70/3E			14.1	82.9	87.9	11000	5400	0.164	0.24	0.34	371	17.16
3x150+3x70/3E			16	89.7	94.7	13000	6750	0.132	0.27	0.32	428	21.45
3x185+3x95/3E			17.8	93.6	98.6	15000	8325	0.108	0.29	0.31	488	26.46

(1) Nominal current carrying capacity for rubber cables laid on a surface, at 30°C ambient temperature (see also VDE 0298-4, Table 15).
For derating-factors see tables in Technical Appendix
Special designs with control-cores and fiber optics available on request

PROTOLON(ST) .../3E NTSCGEW0EU 18/30 kV

Number of cores x cross section	Part number	MLFB Number	Conductor diameter max. mm	Outer diameter min. mm	Outer diameter max. mm	Weight (approx.) kg/km	Permissible tensile force max. N	Conductor resistance at 20°C max. Ω/km	Nominal operating capacitance μF/km	Inductance nom. mH/km	Current carrying capacity (1) A	Short Circuit Current (conductor) kA
3x25+3x25/3E			6.4	67.1	71.1	6300	1125	0.795	0.14	0.46	139	3.58
3x35+3x25/3E	20154158	5DK6***	7.6	70.3	74.3	6720	1575	0.565	0.15	0.43	172	5.01
3x50+3x25/3E			9	75.4	79.4	7900	2250	0.393	0.16	0.41	215	7.15
3x70+3x35/3E			10.9	79	84	9200	3150	0.277	0.18	0.38	265	10.01
3x95+3x50/3E			12.6	86.2	91.2	10950	4275	0.21	0.2	0.37	319	13.59
3x120+3x70/3E			14.1	89.9	94.9	12400	5400	0.164	0.22	0.35	371	17.16
3x150+3x70/3E			16	94.9	99.9	13800	6750	0.132	0.23	0.34	428	21.45
3x185+3x95/3E			17.8	100.5	105.5	15950	8325	0.108	0.25	0.33	488	26.46
3x240+3x120/3E +3x2,5ST	20083958	5DK6708	20.4	108.3	111.3	19480	10800	0.0817	0.26	0.32	574	34.32

(1) Nominal current carrying capacity for rubber cables laid on a surface, at 30°C ambient temperature (see also VDE 0298-4, Table 15).
 For derating-factors see tables in Technical Appendix
 Special designs with control-cores and fiber optics available on request

PROTOLON(ST) NTSCGEW0EU 3 kV – 30 kV

Medium voltage flexible cables for use in water



Application

Power supply cable for use in water, e.g. for connection to dredgers, floating docks, pumps, etc., in applications where high mechanical stresses are to be expected. Also suitable for use in sewage, salt water and brackish water at water depths of up to 500 m.

Global data

Brand	PROTOLON(ST)
Type designation	NTSCGEW0EU
Standard	DIN VDE 0250-813
Certifications / Approvals	MSHA P-189-4 Fire Certificate of Russian Federation GOST -R/-K/-B

Design features

Conductor	Electrolytic copper, tinned, finely stranded (class 5)
PE-Conductor	Split into 3 in the outer interstices.
Insulation	Basic material: EPR, Compound type: 3GI3
Electrical field control	Inner and outer layer of semiconductive rubber compound
Core identification	Natural colouring with black semiconductive rubber
Core arrangement	Three main conductor laid-up with protective-earth conductor split into 3 in the outer interstices
Inner sheath	EPR inner sheath with special water-proof characteristics for prevention of formation of water bubbles, Compound type: GM1B
Outer sheath	Basic material: synthetic elastomer compound e.g. CM, particularly water-proof, Compound type: 5GM3, Color: Red

Electrical parameters

Rated voltage	1.8/3 kV	3.6/6 kV	6/10 kV	8.7/15 kV
Max. permissible operating voltage AC	2.1/3.6 kV	4.2/7.2 kV	6,9/12 kV	10.4/18 kV
Max. permissible operating voltage DC	2.7/5.4 kV	5.4/10.8 kV	9/18 kV	13.5/27 kV
AC test voltage - main cores	6 kV (5 Min.)	11 kV (5 Min.)	17 kV (5 Min.)	24 kV (5 Min.)
	12/20 kV	14/25 kV	18/30 kV	
	13.9/24 kV	17.3/30 kV	20.8/36 kV	
	18/36 kV	22.5/45 kV	27/54 kV	
	29 kV (5 Min.)	36 kV (5 Min.)	43 kV (5 Min.)	

Chemical parameters

Performance against fire	IEC 60332-1-2
Resistance to oil	IEC 60811-404
Weather resistance	Unrestricted use outdoors and indoors, resistant to ozone, UV, and moisture
Water resistance	EN 50525-2-21

Thermal parameters

Max. operating temperature of the conductor	90 °C
Max. short circuit temperature of the conductor	250 °C
Ambient temperature for fixed installation	min -40 °C ; max +80 °C
Ambient temperature in fully flexible operation	min -25 °C ; max +60 °C

Mechanical parameters

Max. tensile load on the conductor	15 N/mm ²
Torsional stress +/-	100 °/m
Bending radii min.	Acc. to DIN VDE 0298 part 3

PROTOLON(ST) NTSCGEWOU 1.8/3 kV

Number of cores x cross section	Part number	MLFB Number	Conductor diameter max. mm	Outer diameter min. mm	Outer diameter max. mm	Weight (approx.) kg/km	Permissible tensile force max. N	Conductor resistance at 20°C max. Ω/km	Nominal operating capacitance μF/km	Inductance nom. mH/km	Current carrying capacity (1) A	Short Circuit Current (conductor) kA
3x25+3x25/3	20117795	5DK2433	6.4	36.1	39.1	2370	1125	0.795	0.33	0.33	131	3.58
3x35+3x25/3	20166303		7.6	37.8	40.8	2600	1575	0.565	0.38	0.31	162	5.01
3x50+3x25/3	20166304	5DK2***	9	42.1	45.1	3320	2250	0.393	0.43	0.3	202	7.15
3x70+3x35/3			10.9	47.4	50.4	4350	3150	0.277	0.5	0.28	250	10.01
3x95+3x50/3	20025759	5DK2480	12.6	53.2	57.2	5850	4275	0.21	0.52	0.27	301	13.59
3x120+3x70/3	20229702	5DK2***	14.1	56.4	60.4	6700	5400	0.164	0.56	0.27	352	17.16
3x150+3x70/3	20163600	5DK2479	16	60.4	64.4	8060	6750	0.132	0.63	0.26	404	21.45
3x185+3x95/3			17.8	66.9	70.9	9450	8325	0.108	0.69	0.25	461	26.46
3x240+3x120/3			20.4	72.4	76.4	11000	10800	0.0817	0.77	0.25	540	34.32

PROTOLON(ST) NTSCGEWOU 3.6/6 kV

Number of cores x cross section	Part number	MLFB Number	Conductor diameter max. mm	Outer diameter min. mm	Outer diameter max. mm	Weight (approx.) kg/km	Permissible tensile force max. N	Conductor resistance at 20°C max. Ω/km	Nominal operating capacitance μF/km	Inductance nom. mH/km	Current carrying capacity (1) A	Short Circuit Current (conductor) kA
3x25+3x25/3	20004485	5DK3201	6.4	40.1	43.1	2620	1125	0.795	0.26	0.35	131	3.58
3x35+3x25/3	20040326	5DK3202	7.6	42.6	45.6	3200	1575	0.565	0.29	0.33	162	5.01
3x50+3x25/3	20004486	5DK3203	9	45.6	48.6	3690	2250	0.393	0.33	0.32	202	7.15
3x70+3x35/3	20141683	5DK3204	10.9	52.2	56.2	5180	3150	0.277	0.38	0.3	250	10.01
3x95+3x50/3	20037272	5DK3511	12.6	58.4	62.4	6600	4275	0.21	0.43	0.29	301	13.59
3x120+3x70/3	20058135	5DK3212	14.2	59.1	63.1	7320	5400	0.164	0.47	0.28	352	17.16
3x150+3x70/3			16	65.6	69.6	8470	6750	0.132	0.52	0.27	404	21.45
3x185+3x95/3	20266828	5DK3***	17.8	69.4	73.4	9850	8325	0.108	0.56	0.26	461	26.46
3x240+3x120/3	20270201	5DK3***	20.4	76.7	80.7	11500	10800	0.0817	0.63	0.25	540	34.32

PROTOLON(ST) NTSCGEWOU 6/10 kV

Number of cores x cross section	Part number	MLFB Number	Conductor diameter max. mm	Outer diameter min. mm	Outer diameter max. mm	Weight (approx.) kg/km	Permissible tensile force max. N	Conductor resistance at 20°C max. Ω/km	Nominal operating capacitance μF/km	Inductance nom. mH/km	Current carrying capacity (1) A	Short Circuit Current (conductor) kA
3x25+3x25/3	20004595	5DK4201	6.4	41.7	44.7	2910	1125	0.795	0.24	0.36	138	3.58
3x35+3x25/3	20006946	5DK4202	7.6	44.3	47.3	3380	1575	0.565	0.27	0.34	171	5.01
3x50+3x25/3	20004596	5DK4205	9	48.9	52.9	4310	2250	0.393	0.3	0.32	214	7.15
3x70+3x35/3	20016313	5DK4208	10.9	53.8	57.8	5380	3150	0.277	0.34	0.31	265	10.01
3x95+3x50/3	20024967	5DK4211	12.6	57.4	61.4	6420	4275	0.21	0.38	0.29	321	13.59
3x120+3x70/3	20168742	5DK4212	14.1	60.6	64.6	7270	5400	0.164	0.42	0.29	372	17.16
3x150+3x70/3	20007894	5DK4213	16	66.4	70.4	9000	6750	0.132	0.46	0.28	428	21.45
3x185+3x95/3			17.8	71.1	75.1	10100	8325	0.108	0.5	0.27	488	26.46
3x240+3x120/3			20.4	77.9	82.9	12000	10800	0.0817	0.56	0.26	575	34.32

(1) Nominal current carrying capacity for rubber cables laid on a surface, at 30°C ambient temperature (see also VDE 0298-4, Table 15). For derating-factors see tables in Technical Appendix
Special designs with control-cores and fiber optics available on request

PROTOLON(ST) NTSCGEWOU 8.7/15 kV

Number of cores x cross section	Part number	MLFB Number	Conductor diameter max. mm	Outer diameter min. mm	Outer diameter max. mm	Weight (approx.) kg/km	Permissible tensile force max. N	Conductor resistance at 20°C max. Ω/km	Nominal operating capacitance μF/km	Inductance nom. mH/km	Current carrying capacity (1) A	Short Circuit Current (conductor) kA
3x25+3x25/3	20024469	5DK5161	6.4	46.4	49.4	3440	1125	0.795	0.2	0.39	138	3.58
3x35+3x25/3	20259710	5DK5***	7.6	48.4	52.4	3730	1575	0.565	0.22	0.37	171	5.01
3x50+3x25/3	20025240	5DK5155	9	53.3	57.3	4880	2250	0.393	0.24	0.35	215	7.15
3x70+3x35/3			10.9	57.3	61.3	5780	3150	0.277	0.28	0.33	265	10.01
3x95+3x50/3			12.6	63.9	67.9	7100	4275	0.21	0.31	0.31	319	13.59
3x120+3x70/3			14.1	67.1	71.1	8250	5400	0.164	0.33	0.3	371	17.16
3x150+3x70/3	20227963	5DK5***	16	72	76	9450	6750	0.132	0.37	0.29	428	21.45
3x185+3x95/3	20085931	5DK5163	17.8	76.6	80.6	11690	8325	0.108	0.4	0.28	488	26.46
3x240+3x120/3			20.4	82.6	87.6	12700	10800	0.0817	0.44	0.27	574	34.32

PROTOLON(ST) NTSCGEWOU 12/20 kV

Number of cores x cross section	Part number	MLFB Number	Conductor diameter max. mm	Outer diameter min. mm	Outer diameter max. mm	Weight (approx.) kg/km	Permissible tensile force max. N	Conductor resistance at 20°C max. Ω/km	Nominal operating capacitance μF/km	Inductance nom. mH/km	Current carrying capacity (1) A	Short Circuit Current (conductor) kA
3x25+3x25/3	20004726	5DK5823	6.4	52	56	4190	1125	0.795	0.17	0.41	139	3.58
3x35+3x25/3	20152410	5DK5702	7.6	54.5	58.5	4720	1575	0.565	0.19	0.39	172	5.01
3x50+3x25/3	20004722	5DK5705	9	57.4	61.4	5460	2250	0.393	0.21	0.37	215	7.15
3x70+3x35/3	20170539	5DK5708	10.9	64.5	68.5	6660	3150	0.277	0.24	0.35	265	10.01
3x95+3x50/3			12.6	68.2	72.2	7760	4275	0.21	0.26	0.33	319	13.59
3x120+3x70/3			14.1	71.3	75.3	8930	5400	0.164	0.28	0.32	371	17.16
3x150+3x70/3	20227965	5DK5***	16	77.5	82.5	10500	6750	0.132	0.31	0.31	428	21.45
3x185+3x95/3			17.8	81.3	86.3	12000	8325	0.108	0.34	0.3	488	26.46
3x240+3x120/3			20.4	88.6	93.6	13800	10800	0.0817	0.38	0.29	574	34.32

PROTOLON(ST) NTSCGEWOU 14/25 kV

Number of cores x cross section	Part number	MLFB Number	Conductor diameter max. mm	Outer diameter min. mm	Outer diameter max. mm	Weight (approx.) kg/km	Permissible tensile force max. N	Conductor resistance at 20°C max. Ω/km	Nominal operating capacitance μF/km	Inductance nom. mH/km	Current carrying capacity (1) A	Short Circuit Current (conductor) kA
3x25+3x25/3	20205375	5DK6230	6.4	57.4	61.4	4670	1125	0.795	0.15	0.44	139	3.58
3x35+3x25/3	20061126	5DK6232	7.6	60	64	5500	1575	0.565	0.16	0.41	172	5.01
3x50+3x25/3			9	64.8	68.8	6220	2250	0.393	0.18	0.39	215	7.15
3x70+3x35/3			10.9	68.8	72.8	7500	3150	0.277	0.2	0.37	265	10.01
3x95+3x50/3			12.6	75.5	79.5	9000	4275	0.21	0.22	0.35	319	13.59
3x120+3x70/3			14.1	78.1	83.1	12250	5400	0.164	0.24	0.34	371	17.16
3x150+3x70/3			16	83	88	11600	6750	0.132	0.27	0.32	428	21.45
3x185+3x95/3			17.8	88.6	93.6	13500	8325	0.108	0.29	0.31	488	26.46
3x240+3x120/3			20.4	94.1	99.1	15500	10800	0.0817	0.32	0.3	574	34.32

(1) Nominal current carrying capacity for rubber cables laid on a surface, at 30°C ambient temperature (see also VDE 0298-4, Table 15). For derating-factors see tables in Technical Appendix
Special designs with control-cores and fiber optics available on request

 PROTOLON(ST) NTSCGEW0EU 18/30 kV

Number of cores x cross section	Part number	MLFB Number	Conductor diameter max. mm	Outer diameter min. mm	Outer diameter max. mm	Weight (approx.) kg/km	Permissible tensile force max. N	Conductor resistance at 20°C max. Ω/km	Nominal operating capacitance μF/km	Inductance nom. mH/km	Current carrying capacity (1) A	Short Circuit Current (conductor) kA
3x25+3x25/3	20271892	5DK6***	6.4	64.3	68.3	5650	1125	0.795	0.14	0.46	139	3.58
3x35+3x25/3			7.6	66.9	70.9	6230	1575	0.565	0.15	0.43	172	5.01
3x50+3x25/3	20273241	5DK6***	9	69.8	73.8	7000	2250	0.393	0.16	0.41	215	7.15
3x70+3x35/3	20157145	5DK6***	10.9	76.8	80.8	8710	3150	0.277	0.18	0.38	265	10.01
3x95+3x50/3	20157146	5DK6***	12.6	79.5	84.5	9910	4275	0.21	0.2	0.37	319	13.59
3x120+3x70/3			14.1	83.2	88.2	11280	5400	0.164	0.22	0.35	371	17.16
3x150+3x70/3	20157147	5DK6***	16	89	94	12910	6750	0.132	0.23	0.34	428	21.45
3x185+3x95/3			17.8	93.7	98.7	14500	8325	0.108	0.25	0.33	488	26.46
3x240+3x120/3			20.4	101	106	16500	10800	0.0817	0.28	0.32	574	34.32

(1) Nominal current carrying capacity for rubber cables laid on a surface, at 30°C ambient temperature (see also VDE 0298-4, Table 15).
For derating-factors see tables in Technical Appendix
Special designs with control-cores and fiber optics available on request

PROTOLON(M) F (N)TSCGEW0EU 3 kV – 30 kV

Medium voltage flexible cables for semiflexible installation



Application

For laying alongside the conveyor belts (also for shiftable units) and on material handling equipment (even with continuous movement such as in cable booms or as connection between upper and lower car) and for connection of submersible pump units.

Global data

Brand	PROTOLON(M)
Type designation	F-(N)TSCGEW0EU
Standard	Based on DIN VDE 0250-813
Certifications / Approvals	Fire Certificate of Russian Federation GOST -R/-K/-B

Design features

Conductor	Electrolytic copper, not tinned, very finely stranded (class 5)
Insulation	PROTOLON, Basic material: EPR, Compound type: Special compound, better 3GI3
Electrical field control	Inner and outer layer of semiconductive rubber compound
Core identification	Natural coloring with black semiconductive rubber on which white digits 1 to 3 are printed
Core arrangement	Three main conductors laid-up, with protective-earth conductor split into 3 in the outer interstices
Inner sheath	Basic material: EPR, Compound type: Special compound
Outer sheath	Basic material: Synthetic elastomer compound e.g. CM, Compound type: better 5GM3, Color: Red

Electrical parameters

Rated voltage	3.6/6 kV	6/10 kV	8.7/15 kV	12/20 kV
Max. permissible operating voltage AC	4.2/7.2 kV	6,9/12 kV	10.4/18 kV	13.9/24 kV
Max. permissible operating voltage DC	5.4/10.8 kV	9/18 kV	13.5/27 kV	18/36 kV
AC test voltage - main cores	11 kV (5 Min.)	17 kV (5 Min.)	24 kV (5 Min.)	29 kV (5 Min.)
	14/25 kV	18/30 kV		
	17.3/30 kV	20.8/36 kV		
	22.5/45 kV	27/54 kV		
	36 kV (5 Min.)	43 kV (5 Min.)		

Chemical parameters

Performance against fire	IEC 60332-1-2
Resistance to oil	IEC 60811-404
Weather resistance	Unrestricted use outdoors and indoors, resistant to ozone, UV and moisture
Water resistance	EN 50525-2-21

Thermal parameters

Max. operating temperature of the conductor	90 °C
Max. short circuit temperature of the conductor	250 °C
Ambient temperature for fixed installation	min -40 °C ; max +80 °C
Ambient temperature in fully flexible operation	min -25 °C ; max +60 °C

Mechanical parameters

Max. tensile load on the conductor	15 N/mm ²
Torsional stress +/-	100 °/m
Bending radii min.	Acc. to DIN VDE 0298 part 3
Additional tests	Torsional StressTest, Roller Bending Test Type C

PROTOLON(M) F (N)TSCGEW0EU 3.6/6 kV

Number of cores x cross section	Part number	MLFB Number	Conductor diameter max. mm	Outer diameter min. mm	Outer diameter max. mm	Weight (approx.) kg/km	Permissible tensile force max. N	Conductor resistance at 20°C max. Ω/km	Nominal operating capacitance μF/km	Inductance nom. mH/km	Current carrying capacity (1) A	Short Circuit Current (conductor) kA
3x25+3x25/3	20004523	5DK3903	6.4	33.6	36.6	2090	1125	0.78	0.35	0.32	131	3.58
3x25+3x50/3			6.4	40.2	41.9	2730	1125	0.78	0.35	0.36	131	3.58
3x35+3x25/3	20006941	5DK3912	7.6	36.1	39.1	2510	1575	0.554	0.39	0.31	162	5.01
3x35+2x25/2+1x10	20220184	5DK3***	7.6	41	44	3000	1575	0.554	0.39	0.31	162	5.01
3x35+3x50/3			7.6	41.7	44.7	3190	1575	0.554	0.39	0.33	162	5.01
3x50+3x25/3	20007759	5DK3066	9.1	40.4	43.4	3210	2250	0.386	0.45	0.29	202	7.15
3x50+3x50/3	20004467	5DK3068	9.1	42.9	45.9	3640	2250	0.386	0.46	0.29	202	7.15
3x70+3x35/3	20001438	5DK3071	10.8	43.9	46.9	4070	3150	0.272	0.51	0.28	250	10.01
3x70+3x50/3	20001439	5DK3072	10.8	44.4	47.4	4240	3150	0.272	0.51	0.28	250	10.01
3x95+3x50/3	20004522	5DK3876	12.7	49.7	53.7	5300	4275	0.206	0.58	0.27	301	13.59
3x120+3x70/3	20004520	5DK3872	14.3	53.1	57.1	6430	5400	0.161	0.64	0.26	352	17.16
3x150+3x70/3	20151774	5DK3076	16	56.8	60.8	7310	6750	0.129	0.71	0.25	404	21.45
3x185+3x95/3	20007275	5DK3877	17.7	61.7	65.7	9000	8325	0.106	0.77	0.25	461	26.46
3x240+3x120/3	20014793	5DK3846	20.6	68.4	72.4	11280	10800	0.0801	0.8	0.24	540	34.32
3x300+3x150/3	20014794	5DK3847	23.1	75.1	79.1	13770	13500	0.0641	0.85	0.23	620	42.9

PROTOLON(M) F (N)TSCGEW0EU 6/10 kV

Number of cores x cross section	Part number	MLFB Number	Conductor diameter max. mm	Outer diameter min. mm	Outer diameter max. mm	Weight (approx.) kg/km	Permissible tensile force max. N	Conductor resistance at 20°C max. Ω/km	Nominal operating capacitance μF/km	Inductance nom. mH/km	Current carrying capacity (1) A	Short Circuit Current (conductor) kA
3x25+3x25/3	20004612	5DK4328	6.4	34.9	37.9	2190	1125	0.78	0.31	0.33	131	3.58
3x25+3x50/3	20004613	5DK4329	6.4	39.9	42.9	2830	1125	0.78	0.31	0.35	131	3.58
3x35+3x25/3	20004615	5DK4332	7.6	38.4	41.4	2710	1575	0.554	0.35	0.32	162	5.01
3x35+3x35/3	20214151	5DK4501	7.6	38.4	41.4	2790	1575	0.554	0.35	0.34	162	5.01
3x35+3x50/3	20004614	5DK4331	7.6	41.9	44.9	3230	1575	0.554	0.35	0.34	162	5.01
3x50+3x25/3	20007428	5DK4333	9.1	41.6	44.6	3340	2250	0.386	0.4	0.3	202	7.15
3x50+3x50/3	20004616	5DK4334	9.1	42.2	45.2	3590	2250	0.386	0.4	0.3	202	7.15
3x70+3x35/3	20004639	5DK4493	10.8	45.2	48.2	4200	3150	0.272	0.46	0.29	250	10.01
3x70+3x50/3	20001447	5DK4345	10.8	45.2	48.2	4300	3150	0.272	0.46	0.29	250	10.01
3x95+3x50/3	20004641	5DK4496	12.7	50.9	54.9	5440	4275	0.206	0.52	0.27	301	13.59
3x95+3x70/3	20214152	5DK4502	12.7	50.9	54.9	5610	4275	0.206	0.52	0.27	301	13.59
3x120+3x70/3	20004619	5DK4337	14.3	54.4	58.4	6600	5400	0.161	0.57	0.27	352	17.16
3x150+3x70/3	20004642	5DK4498	16	57.9	61.9	7670	6750	0.129	0.63	0.26	404	21.45
3x185+3x95/3	20004643	5DK4499	17.7	62.5	66.5	9170	8325	0.106	0.68	0.25	461	26.46
3x240+3x120/3	20157800	5DK4***	20.6	68.7	72.7	11540	10800	0.0801	0.7	0.25	540	34.32

(1) Nominal current carrying capacity for rubber cables laid on a surface, at 30°C ambient temperature (see also VDE 0298-4, Table 15). For derating-factors see tables in Technical Appendix

PROTOLON(M) F (N)TSCGEW0EU 8.7/15 kV

Number of cores x cross section	Part number	MLFB Number	Conductor diameter max. mm	Outer diameter min. mm	Outer diameter max. mm	Weight (approx.) kg/km	Permissible tensile force max. N	Conductor resistance at 20°C max. Ω/km	Nominal operating capacitance μF/km	Inductance nom. mH/km	Current carrying capacity (1) A	Short Circuit Current (conductor) kA
3x25+3x25/3	20171875	5DK5***	6.4	40.2	43.2	2690	1125	0.78	0.24	0.36	139	3.58
3x25+3x50/3			6.4	41.8	44.8	3050	1125	0.78	0.24	0.38	139	3.58
3x35+3x25/3			7.6	41.8	44.8	2930	1575	0.554	0.27	0.34	172	5.01
3x35+3x50/3			7.6	41.8	44.8	3300	1575	0.554	0.27	0.34	172	5.01
3x50+3x25/3	20194632	5DK5143	9.1	45	48	3550	2250	0.386	0.3	0.32	215	7.15
3x50+3x50/3	20224829	5DK5***	9.1	45	48	3930	2250	0.386	0.3	0.32	215	7.15
3x70+3x35/3			10.8	49.5	53.5	4590	3150	0.272	0.34	0.31	265	10.01
3x70+3x50/3			10.8	49.9	53.9	4950	3150	0.272	0.34	0.31	265	10.01
3x95+3x50/3	20004685	5DK5146	12.7	54.4	58.4	5930	4275	0.202	0.39	0.29	319	13.59
3x120+3x70/3	20153603	5DK5***	14.3	57.3	61.3	7020	5400	0.161	0.42	0.28	371	17.16
3x150+3x70/3	20225874	5DK5***	16	63.8	67.8	8220	6750	0.129	0.46	0.28	428	21.45
3x185+3x95/3	20161385	5DK5***	17.7	65.9	69.9	9760	8325	0.106	0.5	0.27	488	26.46

PROTOLON(M) F (N)TSCGEW0EU 12/20 kV

Number of cores x cross section	Part number	MLFB Number	Conductor diameter max. mm	Outer diameter min. mm	Outer diameter max. mm	Weight (approx.) kg/km	Permissible tensile force max. N	Conductor resistance at 20°C max. Ω/km	Nominal operating capacitance μF/km	Inductance nom. mH/km	Current carrying capacity (1) A	Short Circuit Current (conductor) kA
3x25+3x25/3	20008856	5DK5682	6.4	42.3	45.3	2870	1125	0.78	0.22	0.37	139	3.58
3x25+3x50/3			6.4	42.3	45.3	3120	1125	0.78	0.22	0.37	139	3.58
3x35+3x25/3	20163964	5DK5684	7.6	45.8	48.8	3470	1575	0.554	0.24	0.35	172	5.01
3x35+3x50/3			7.6	44.8	47.8	3620	1575	0.554	0.24	0.35	172	5.01
3x50+3x25/3	20014374	5DK5691	9.1	47.9	50.9	4010	2250	0.386	0.27	0.33	215	7.15
3x50+3x50/3			9.1	47.9	50.9	4430	2250	0.386	0.27	0.33	215	7.15
3x70+3x35/3	20007431	5DK5686	10.8	52.4	56.4	5110	3150	0.272	0.31	0.32	265	10.01
3x70+3x50/3	20058841	5DK5687	10.8	52.4	56.4	5270	3150	0.272	0.35	0.32	265	10.01
3x95+3x50/3	20101416	5DK5688	12.7	56.5	60.5	6170	4275	0.206	0.35	0.3	319	13.59
3x120+3x70/3	20004720	5DK5689	14.3	61.7	65.7	7650	5400	0.161	0.38	0.29	371	17.16
3x150+3x70/3	20004721	5DK5690	16	65.9	69.9	8930	6750	0.129	0.41	0.28	428	21.45
3x185+3x95/3	20151697	5DK5689	17.7	68.8	72.8	10230	8325	0.106	0.45	0.28	488	26.46

(1) Nominal current carrying capacity for rubber cables laid on a surface, at 30°C ambient temperature (see also VDE 0298-4, Table 15). For derating-factors see tables in Technical Appendix

PROTOLON(M) F (N)TSCGEW0EU 14/25 kV

Number of cores x cross section	Part number	MLFB Number	Conductor diameter max. mm	Outer diameter min. mm	Outer diameter max. mm	Weight (approx.) kg/km	Permissible tensile force max. N	Conductor resistance at 20°C max. Ω/km	Nominal operating capacitance μF/km	Inductance nom. mH/km	Current carrying capacity (1) A	Short Circuit Current (conductor) kA
3x25+3x25/3	20220192	5DK6***	6.4	46	49	3120	1125	0.78	0.19	0.4	139	3.58
3x35+3x25/3	20098412	5DK6464	7.6	49.5	53.5	3930	1575	0.554	0.21	0.37	172	5.01
3x35+3x35/3	20213010	5DK6***	7.6	49.5	53.5	3890	1575	0.554	0.21	0.37	172	5.01
3x50+3x25/3	20170690	5DK6*	9.1	53.3	57.3	4760	2250	0.386	0.23	0.35	215	7.15
3x70+3x35/3	20008497	5DK6469	10.8	56.2	60.2	5570	3150	0.272	0.26	0.33	265	10.01
3x70+3x50/3	20008499	5DK6470	10.8	56.8	60.8	5710	3150	0.272	0.26	0.33	265	10.01
3x95+3x50/3	20155393		12.7	61.9	65.9	6990	4275	0.206	0.29	0.32	319	13.59
3x120+3x70/3	20129015	5DK6472	14.3	65.9	69.9	8200	5400	0.161	0.32	0.31	371	17.16
3x150+3x70/3	20183334	5DK6...	16	70.6	74.6	9210	6750	0.129	0.35	0.3	428	21.45
3x185+3x95/3			17.7	75.5	79.5	10820	8325	0.106	0.38	0.29	488	26.46

PROTOLON(M) F (N)TSCGEW0EU 18/30 kV

Number of cores x cross section	Part number	MLFB Number	Conductor diameter max. mm	Outer diameter min. mm	Outer diameter max. mm	Weight (approx.) kg/km	Permissible tensile force max. N	Conductor resistance at 20°C max. Ω/km	Nominal operating capacitance μF/km	Inductance nom. mH/km	Current carrying capacity (1) A	Short Circuit Current (conductor) kA
3x25+3x25/3	20171275	5DK6844	6.4	47	51	3650	1125	0.78	0.17	0.42	139	3.58
3x35+3x25/3	20014796	5DK6845	7.6	52.9	56.9	4350	1575	0.554	0.18	0.39	172	5.01
3x50+3x25/3	20174410	5DK6...	9.1	52.6	56.6	4850	2250	0.386	0.2	0.37	215	7.15
3x70+3x35/3	20156750	5DK6***	10.8	61.7	65.7	6420	3150	0.272	0.23	0.35	265	10.01
3x95+3x50/3	20008614	5DK6850	12.7	65.1	69.1	7410	4275	0.206	0.25	0.33	319	13.59
3x120+3x70/3	20004748	5DK6852	14.3	68.8	72.8	8660	5400	0.161	0.28	0.32	371	17.16
3x150+3x70/3	20172216	5DK6***	16	75.3	79.3	9970	6750	0.129	0.3	0.31	428	21.45
3x185+3x95/3	20007274	5DK6856	17.7	78.9	82.9	11730	8325	0.106	0.32	0.3	488	26.46
3x240+3x120/3	20008496	5DK6857	20.6	84.4	89.4	14510	10800	0.0801	0.35	0.29	574	34.32

(1) Nominal current carrying capacity for rubber cables laid on a surface, at 30°C ambient temperature (see also VDE 0298-4, Table 15). For derating-factors see tables in Technical Appendix

PROTOLON(M) F (N)TSCGEW0EU 3 kV – 30 kV

Medium voltage flexible cables for semiflexible installation



Application

For laying alongside the conveyor belts (also for shiftable units) and on material handling equipment (even with continuous movement such as in cable booms or as connection between upper and lower car) and for connection of submersible pump units.

Global data

Brand	PROTOLON(M)
Type designation	F-(N)TSCGEW0EU
Standard	Based on DIN VDE 0250-813
Certifications / Approvals	Fire Certificate of Russian Federation GOST -R/-K/-B

Design features

Conductor	Electrolytic copper, not tinned, very finely stranded (class 5)
Insulation	PROTOLON, Basic material: EPR, Compound type: Special compound, better 3GI3
Electrical field control	Inner and outer layer of semiconductive rubber compound
Core identification	Natural coloring with black semiconductive rubber on which white digits 1 to 3 are printed
Core arrangement	Three main conductors laid-up, with protective-earth conductor split into 3 in the outer interstices
Inner sheath	Basic material: EPR, Compound type: Special compound
Outer sheath	Basic material: Synthetic elastomer compound e.g. CM, Compound type: better 5GM3, Color: Red

Electrical parameters

Rated voltage	3.6/6 kV	6/10 kV	8.7/15 kV	12/20 kV
Max. permissible operating voltage AC	4.2/7.2 kV	6,9/12 kV	10.4/18 kV	13.9/24 kV
Max. permissible operating voltage DC	5.4/10.8 kV	9/18 kV	13.5/27 kV	18/36 kV
AC test voltage - main cores	11 kV (5 Min.)	17 kV (5 Min.)	24 kV (5 Min.)	29 kV (5 Min.)
	14/25 kV	18/30 kV		
	17.3/30 kV	20.8/36 kV		
	22.5/45 kV	27/54 kV		
	36 kV (5 Min.)	43 kV (5 Min.)		

Chemical parameters

Performance against fire	IEC 60332-1-2
Resistance to oil	IEC 60811-404
Weather resistance	Unrestricted use outdoors and indoors, resistant to ozone, UV and moisture
Water resistance	EN 50525-2-21

Thermal parameters

Max. operating temperature of the conductor	90 °C
Max. short circuit temperature of the conductor	250 °C
Ambient temperature for fixed installation	min -40 °C ; max +80 °C
Ambient temperature in fully flexible operation	min -25 °C ; max +60 °C

Mechanical parameters

Max. tensile load on the conductor	15 N/mm ²
Torsional stress +/-	100 °/m
Bending radii min.	Acc. to DIN VDE 0298 part 3
Additional tests	Torsional StressTest, Roller Bending Test Type C

PROTOLON(M) F (N)TSCGEWUEU 3.6/6 kV

Number of cores x cross section	Part number	MLFB Number	Conductor diameter max. mm	Outer diameter min. mm	Outer diameter max. mm	Weight (approx.) kg/km	Permissible tensile force max. N	Conductor resistance at 20°C max. Ω/km	Nominal operating capacitance μF/km	Inductance nom. mH/km	Current carrying capacity (1) A	Short Circuit Current (conductor) kA
3x25+3x25/3	20004523	5DK3903	6.4	33.6	36.6	2090	1125	0.78	0.35	0.32	131	3.58
3x25+3x50/3			6.4	40.2	41.9	2730	1125	0.78	0.35	0.36	131	3.58
3x35+3x25/3	20006941	5DK3912	7.6	36.1	39.1	2510	1575	0.554	0.39	0.31	162	5.01
3x35+2x25/2+1x10	20220184	5DK3***	7.6	41	44	3000	1575	0.554	0.39	0.31	162	5.01
3x35+3x50/3			7.6	41.7	44.7	3190	1575	0.554	0.39	0.33	162	5.01
3x50+3x25/3	20007759	5DK3066	9.1	40.4	43.4	3210	2250	0.386	0.45	0.29	202	7.15
3x50+3x50/3	20004467	5DK3068	9.1	42.9	45.9	3640	2250	0.386	0.46	0.29	202	7.15
3x70+3x35/3	20001438	5DK3071	10.8	43.9	46.9	4070	3150	0.272	0.51	0.28	250	10.01
3x70+3x50/3	20001439	5DK3072	10.8	44.4	47.4	4240	3150	0.272	0.51	0.28	250	10.01
3x95+3x50/3	20004522	5DK3876	12.7	49.7	53.7	5300	4275	0.206	0.58	0.27	301	13.59
3x120+3x70/3	20004520	5DK3872	14.3	53.1	57.1	6430	5400	0.161	0.64	0.26	352	17.16
3x150+3x70/3	20151774	5DK3076	16	56.8	60.8	7310	6750	0.129	0.71	0.25	404	21.45
3x185+3x95/3	20007275	5DK3877	17.7	61.7	65.7	9000	8325	0.106	0.77	0.25	461	26.46
3x240+3x120/3	20014793	5DK3846	20.6	68.4	72.4	11280	10800	0.0801	0.8	0.24	540	34.32
3x300+3x150/3	20014794	5DK3847	23.1	75.1	79.1	13770	13500	0.0641	0.85	0.23	620	42.9

PROTOLON(M) F (N)TSCGEWUEU 6/10 kV

Number of cores x cross section	Part number	MLFB Number	Conductor diameter max. mm	Outer diameter min. mm	Outer diameter max. mm	Weight (approx.) kg/km	Permissible tensile force max. N	Conductor resistance at 20°C max. Ω/km	Nominal operating capacitance μF/km	Inductance nom. mH/km	Current carrying capacity (1) A	Short Circuit Current (conductor) kA
3x25+3x25/3	20004612	5DK4328	6.4	34.9	37.9	2190	1125	0.78	0.31	0.33	131	3.58
3x25+3x50/3	20004613	5DK4329	6.4	39.9	42.9	2830	1125	0.78	0.31	0.35	131	3.58
3x35+3x25/3	20004615	5DK4332	7.6	38.4	41.4	2710	1575	0.554	0.35	0.32	162	5.01
3x35+3x35/3	20214151	5DK4501	7.6	38.4	41.4	2790	1575	0.554	0.35	0.34	162	5.01
3x35+3x50/3	20004614	5DK4331	7.6	41.9	44.9	3230	1575	0.554	0.35	0.34	162	5.01
3x50+3x25/3	20007428	5DK4333	9.1	41.6	44.6	3340	2250	0.386	0.4	0.3	202	7.15
3x50+3x50/3	20004616	5DK4334	9.1	42.2	45.2	3590	2250	0.386	0.4	0.3	202	7.15
3x70+3x35/3	20004639	5DK4493	10.8	45.2	48.2	4200	3150	0.272	0.46	0.29	250	10.01
3x70+3x50/3	20001447	5DK4345	10.8	45.2	48.2	4300	3150	0.272	0.46	0.29	250	10.01
3x95+3x50/3	20004641	5DK4496	12.7	50.9	54.9	5440	4275	0.206	0.52	0.27	301	13.59
3x95+3x70/3	20214152	5DK4502	12.7	50.9	54.9	5610	4275	0.206	0.52	0.27	301	13.59
3x120+3x70/3	20004619	5DK4337	14.3	54.4	58.4	6600	5400	0.161	0.57	0.27	352	17.16
3x150+3x70/3	20004642	5DK4498	16	57.9	61.9	7670	6750	0.129	0.63	0.26	404	21.45
3x185+3x95/3	20004643	5DK4499	17.7	62.5	66.5	9170	8325	0.106	0.68	0.25	461	26.46
3x240+3x120/3	20157800	5DK4***	20.6	68.7	72.7	11540	10800	0.0801	0.7	0.25	540	34.32

(1) Nominal current carrying capacity for rubber cables laid on a surface, at 30°C ambient temperature (see also VDE 0298-4, Table 15). For derating-factors see tables in Technical Appendix

PROTOLON(M) F (N)TSCGEWUEU 8.7/15 kV

Number of cores x cross section	Part number	MLFB Number	Conductor diameter max. mm	Outer diameter min. mm	Outer diameter max. mm	Weight (approx.) kg/km	Permissible tensile force max. N	Conductor resistance at 20°C max. Ω/km	Nominal operating capacitance μF/km	Inductance nom. mH/km	Current carrying capacity (1) A	Short Circuit Current (conductor) kA
3x25+3x25/3	20171875	5DK5***	6.4	40.2	43.2	2690	1125	0.78	0.24	0.36	139	3.58
3x25+3x50/3			6.4	41.8	44.8	3050	1125	0.78	0.24	0.38	139	3.58
3x35+3x25/3			7.6	41.8	44.8	2930	1575	0.554	0.27	0.34	172	5.01
3x35+3x50/3			7.6	41.8	44.8	3300	1575	0.554	0.27	0.34	172	5.01
3x50+3x25/3	20194632	5DK5143	9.1	45	48	3550	2250	0.386	0.3	0.32	215	7.15
3x50+3x50/3	20224829	5DK5***	9.1	45	48	3930	2250	0.386	0.3	0.32	215	7.15
3x70+3x35/3			10.8	49.5	53.5	4590	3150	0.272	0.34	0.31	265	10.01
3x70+3x50/3			10.8	49.9	53.9	4950	3150	0.272	0.34	0.31	265	10.01
3x95+3x50/3	20004685	5DK5146	12.7	54.4	58.4	5930	4275	0.202	0.39	0.29	319	13.59
3x120+3x70/3	20153603	5DK5***	14.3	57.3	61.3	7020	5400	0.161	0.42	0.28	371	17.16
3x150+3x70/3	20225874	5DK5***	16	63.8	67.8	8220	6750	0.129	0.46	0.28	428	21.45
3x185+3x95/3	20161385	5DK5***	17.7	65.9	69.9	9760	8325	0.106	0.5	0.27	488	26.46

PROTOLON(M) F (N)TSCGEWUEU 12/20 kV

Number of cores x cross section	Part number	MLFB Number	Conductor diameter max. mm	Outer diameter min. mm	Outer diameter max. mm	Weight (approx.) kg/km	Permissible tensile force max. N	Conductor resistance at 20°C max. Ω/km	Nominal operating capacitance μF/km	Inductance nom. mH/km	Current carrying capacity (1) A	Short Circuit Current (conductor) kA
3x25+3x25/3	20008856	5DK5682	6.4	42.3	45.3	2870	1125	0.78	0.22	0.37	139	3.58
3x25+3x50/3			6.4	42.3	45.3	3120	1125	0.78	0.22	0.37	139	3.58
3x35+3x25/3	20163964	5DK5684	7.6	45.8	48.8	3470	1575	0.554	0.24	0.35	172	5.01
3x35+3x50/3			7.6	44.8	47.8	3620	1575	0.554	0.24	0.35	172	5.01
3x50+3x25/3	20014374	5DK5691	9.1	47.9	50.9	4010	2250	0.386	0.27	0.33	215	7.15
3x50+3x50/3			9.1	47.9	50.9	4430	2250	0.386	0.27	0.33	215	7.15
3x70+3x35/3	20007431	5DK5686	10.8	52.4	56.4	5110	3150	0.272	0.31	0.32	265	10.01
3x70+3x50/3	20058841	5DK5687	10.8	52.4	56.4	5270	3150	0.272	0.35	0.32	265	10.01
3x95+3x50/3	20101416	5DK5688	12.7	56.5	60.5	6170	4275	0.206	0.35	0.3	319	13.59
3x120+3x70/3	20004720	5DK5689	14.3	61.7	65.7	7650	5400	0.161	0.38	0.29	371	17.16
3x150+3x70/3	20004721	5DK5690	16	65.9	69.9	8930	6750	0.129	0.41	0.28	428	21.45
3x185+3x95/3	20151697	5DK5689	17.7	68.8	72.8	10230	8325	0.106	0.45	0.28	488	26.46

(1) Nominal current carrying capacity for rubber cables laid on a surface, at 30°C ambient temperature (see also VDE 0298-4, Table 15). For derating-factors see tables in Technical Appendix

PROTOLON(M) F (N)TSCGEW0EU 14/25 kV

Number of cores x cross section	Part number	MLFB Number	Conductor diameter max. mm	Outer diameter min. mm	Outer diameter max. mm	Weight (approx.) kg/km	Permissible tensile force max. N	Conductor resistance at 20°C max. Ω/km	Nominal operating capacitance μF/km	Inductance nom. mH/km	Current carrying capacity (1) A	Short Circuit Current (conductor) kA
3x25+3x25/3	20220192	5DK6***	6.4	46	49	3120	1125	0.78	0.19	0.4	139	3.58
3x35+3x25/3	20098412	5DK6464	7.6	49.5	53.5	3930	1575	0.554	0.21	0.37	172	5.01
3x35+3x35/3	20213010	5DK6***	7.6	49.5	53.5	3890	1575	0.554	0.21	0.37	172	5.01
3x50+3x25/3	20170690	5DK6*	9.1	53.3	57.3	4760	2250	0.386	0.23	0.35	215	7.15
3x70+3x35/3	20008497	5DK6469	10.8	56.2	60.2	5570	3150	0.272	0.26	0.33	265	10.01
3x70+3x50/3	20008499	5DK6470	10.8	56.8	60.8	5710	3150	0.272	0.26	0.33	265	10.01
3x95+3x50/3	20155393		12.7	61.9	65.9	6990	4275	0.206	0.29	0.32	319	13.59
3x120+3x70/3	20129015	5DK6472	14.3	65.9	69.9	8200	5400	0.161	0.32	0.31	371	17.16
3x150+3x70/3	20183334	5DK6...	16	70.6	74.6	9210	6750	0.129	0.35	0.3	428	21.45
3x185+3x95/3			17.7	75.5	79.5	10820	8325	0.106	0.38	0.29	488	26.46

PROTOLON(M) F (N)TSCGEW0EU 18/30 kV

Number of cores x cross section	Part number	MLFB Number	Conductor diameter max. mm	Outer diameter min. mm	Outer diameter max. mm	Weight (approx.) kg/km	Permissible tensile force max. N	Conductor resistance at 20°C max. Ω/km	Nominal operating capacitance μF/km	Inductance nom. mH/km	Current carrying capacity (1) A	Short Circuit Current (conductor) kA
3x25+3x25/3	20171275	5DK6844	6.4	47	51	3650	1125	0.78	0.17	0.42	139	3.58
3x35+3x25/3	20014796	5DK6845	7.6	52.9	56.9	4350	1575	0.554	0.18	0.39	172	5.01
3x50+3x25/3	20174410	5DK6...	9.1	52.6	56.6	4850	2250	0.386	0.2	0.37	215	7.15
3x70+3x35/3	20156750	5DK6***	10.8	61.7	65.7	6420	3150	0.272	0.23	0.35	265	10.01
3x95+3x50/3	20008614	5DK6850	12.7	65.1	69.1	7410	4275	0.206	0.25	0.33	319	13.59
3x120+3x70/3	20004748	5DK6852	14.3	68.8	72.8	8660	5400	0.161	0.28	0.32	371	17.16
3x150+3x70/3	20172216	5DK6***	16	75.3	79.3	9970	6750	0.129	0.3	0.31	428	21.45
3x185+3x95/3	20007274	5DK6856	17.7	78.9	82.9	11730	8325	0.106	0.32	0.3	488	26.46
3x240+3x120/3	20008496	5DK6857	20.6	84.4	89.4	14510	10800	0.0801	0.35	0.29	574	34.32

(1) Nominal current carrying capacity for rubber cables laid on a surface, at 30°C ambient temperature (see also VDE 0298-4, Table 15). For derating-factors see tables in Technical Appendix

PROTOMONT NSSHOEU 1 kV

Low Voltage flexible rubber cable



Application

For flexible use and fixed installation open-cast mining applications, in quarries, on construction sites and similar applications, with heavy mechanical stresses. The cables can be used indoors as well as outdoors, in explosion-hazard areas, in industry and in agriculture. They can be used permanently in waste water up to 40°C at a depth of max. 2000 m and in industrial water, cooling water, surface water, rainwater and mixed water - and in groundwater and seawater to a more limited extent. The requirements for accessibility and inspection depend on the consistency of the water. In aggressive water or composed of special substances, the cable's resistance properties should be tested. In other respects the specifications of DIN VDE 0298 part 3 applies.

Global data

Brand	PROTOMONT
Type designation	NSSHOEU
Standard	DIN VDE 0250-812
Certifications / Approvals	MA – China MSHA P-189-3 EAC Certificate

Notes on installation

Notes on installation	Maximum submersing depth 2000 meters
-----------------------	--------------------------------------

Design features

Conductor	Electrolytic copper, tinned, finely stranded (class 5) acc. to DIN EN 60228 / IEC 60228
Insulation	PROTOLON, Basic material: EPR, Compound type: 3GI3 in accordance with DIN EN 50363
Core identification	Up to 5 cores: colored in accordance with DIN VDE 0293-308 from 6 cores: light colored with black numbers
Inner sheath	Vulcanized rubber compound, Basic material: EPR, Compound type: GM1B in accordance with DIN EN 50363 (not for single-core cables)
Outer sheath	Vulcanized rubber compound, synthetic elastomer compound e.g. CPE, Compound: 5GM5 in accordance with DIN EN 50363, Color: Yellow

Electrical parameters

Rated voltage	0.6/1 kV (600/1000V)
Max. permissible operating voltage AC	0.7/1.2 kV
Max. permissible operating voltage DC	0.9/1.8 kV
AC test voltage - main cores	3,5 kV (5 Min.)

Chemical parameters

Performance against fire	DIN EN 60332-1-2
Resistance to oil	DIN EN 60811-404
Weather resistance	Unrestricted use outdoors and indoors, resistant to ozone and moisture
Water resistance	DIN EN 50525-2-21

Thermal parameters

Max. operating temperature of the conductor	90 °C
Max. short circuit temperature of the conductor	250 °C
Max. permissible water temperature	40 °C (At higher water temperatures, a shortened cable service life is to be expected)
Ambient temperature for fixed installation	min -40 °C ; max +80 °C
Ambient temperature in fully flexible operation	min -25 °C ; max +60 °C

Mechanical parameters

Max. tensile load on the conductor	15 N/mm ²
Torsional stress +/-	100 %/m
Bending radii min.	Acc. to DIN VDE 0298 part 3

PROTOMONT NSSHOEU 0.6/1 kV

Number of cores x cross section	Part number	MLFB Number	Conductor diameter max. mm	Outer diameter min. mm	Outer diameter max. mm	Bending radius fixed min. mm	Bending radius free moving min. mm	Weight (approx.) kg/km	Permissible tensile force max. N	Conductor resistance at 20°C max. Ω/km	Nominal operating capacitance μF/km	Inductance nom. mH/km	Current carrying capacity (1) A	Short Circuit Current (conductor) kA
PROTOMONT NSSHÖU-O 1x...														
1x16	20004811	5DL1112	5.4	10.6	11.6	35	46	240	240	1.21	0.42	0.26	135	2.29
1x25	20008654	5DL1113	6.3	10	13.7	55	69	360	375	0.7839	0.42	0.26	178	3.58
1x35	20004812	5DL1114	7.4	13.7	14.9	60	75	460	525	0.554	0.49	0.25	220	5.01
1x50	20004813	5DL1115	8.8	15.2	16.7	67	84	630	750	0.386	0.51	0.25	275	7.15
1x70	20004814	5DL1116	10.6	14.5	18.8	75	94	850	1050	0.272	0.59	0.24	340	10.01
1x95	20004815	5DL1117	12.1	19.4	20.9	84	105	1070	1425	0.206	0.6	0.24	409	13.59
1x120	20004816	5DL1118	14.3	18.3	23.4	94	117	1370	1800	0.161	0.69	0.23	479	17.16
1x150	20004817	5DL1120	15.9	23.9	25.4	102	127	1660	2250	0.129	0.69	0.23	549	21.45
1x185	20069571	5DL1121	17.5	26.6	28.8	115	144	2060	2775	0.106	0.68	0.23	627	26.46
1x240	20004818	5DL1122	20.3	29.8	32	128	160	2630	3600	0.0801	0.73	0.23	734	34.32
1x300	20004819	5DL1123	23.1	34.6	36.8	147	184	3300	4500	0.0641	0.76	0.23	843	42.9
1x400	20154805	5DL1124	26.2	38.5	40.5	162	203	4260	6000	0.0486	0.76	0.24	1024	57.2
PROTOMONT NSSHÖU-O 2x...														
2x1,5	20004826	5DL1204	1.6	10.3	11.9	36	48	170	45	13.3	0.22	0.33	23	0.21
2x2,5	20008593	5DL1205	1.9	11.4	13	52	65	210	75	7.98	0.23	0.32	30	0.36
2x4	20227264	5DL1206	2.4	7.5	9.5	29	38	220	120	4.95	0.26	0.31	41	0.57
PROTOMONT NSSHÖU-O 3x...														
3x1,5	20231497	5DL1***	1.6	10.8	12.4	50	62	180	68	13.3	0.22	0.33	23	0.21
3x2,5	20004872	5DL1751	1.9	12	13.6	54	68	240	113	7.98	0.23	0.32	30	0.36
3x4		5DL1760	2.4	14.7	16.7	67	84	340	180	4.95	0.26	0.31	41	0.57
3x6		5DL1946	2.9	15.7	17.7	71	89	415	270	3.3	0.3	0.29	53	0.86
3x10	20141441	5DL1901	3.9	20.7	21.8	87	109	680	450	1.91	0.32	0.28	74	1.43
3x16	20173651	5DL1311	5.4	22.2	24.2	97	121	890	720	1.21	0.42	0.26	99	2.29
3x25	20004897	5DL1964	6.3	26.8	28.5	114	143	1330	1125	0.784	0.42	0.26	131	3.58
3x35	20004837	5DL1391	7.5	29.5	32.5	130	163	1770	1575	0.554	0.49	0.25	162	5.01
3x50	20148227	5DL1393	8.9	35.2	38.3	153	192	2450	2250	0.386	0.55	0.27	202	7.15
3x70	20008777	5DL1767	10.6	39.1	42.1	168	211	3170	3150	0.272	0.57	0.28	250	10.01
PROTOMONT NSSHÖU-J 3x...														
3x1,5	20004827	5DL1304	1.6	10.7	12.3	49	62	190	68	13.3	0.22	0.33	23	0.21
3x2,5	20004828	5DL1305	1.9	12	13.6	54	68	240	113	7.98	0.23	0.32	30	0.36
3x4	20007174	5DL1306	2.4	14.2	16.2	65	81	350	180	4.95	0.26	0.31	41	0.57
3x6		5DL1914	2.9	16.6	18.6	74	93	415	270	3.3	0.3	0.29	53	0.86
4x1,5	20085843	5DL1403	1.6	12	13.1	52	66	220	90	13.3	0.22	0.33	23	0.21
PROTOMONT NSSHÖU-J 4x...														
4x1,5	20004838	5DL1404	1.6	11.5	13.1	52	66	220	90	13.3	0.22	0.33	23	0.21
4x2,5	20004839	5DL1405	1.9	13.7	15.7	63	79	320	150	7.98	0.23	0.32	30	0.36
4x4	20004840	5DL1406	2.4	15.3	17.3	69	87	420	240	4.95	0.26	0.31	41	0.57
4x6	20004841	5DL1407	2.9	16.5	18.5	74	93	520	360	3.3	0.3	0.29	53	0.86
4x10	20004842	5DL1410	3.9	20.9	22.9	92	115	830	600	1.91	0.32	0.28	74	1.43
4x16	20004843	5DL1412	5.4	25.9	27.6	110	138	1190	960	1.21	0.42	0.26	99	2.29
4x16+4x2,5	20004871	5DL1749	5.4	27.1	30.1	120	151	1480	960	1.21	0.42	0.26	99	2.29
4x25	20004844	5DL1413	6.3	29.3	32.3	129	162	1740	1500	0.7839	0.42	0.26	131	3.58
4x25+1x(4x1,5)ST	20220185	5DL1***	6.3	32.4	35.4	142	177	2000	1500	0.784	0.42	0.26	131	3.58

(1) Nominal current carrying capacity for rubber cables laid on a surface, at 30°C ambient temperature (see also VDE 0298-4, Table 15). For derating-factors see tables in Technical Appendix

Special designs available upon request, e.g.:

- special black outer sheath for -45°C

- halogen-free version with 5GM3 outer sheath

Continued from previous page.

PROTOMONT NSSHOEU 0.6/1 kV

Number of cores x cross section	Part number	MLFB Number	Conductor diameter max. mm	Outer diameter min. mm	Outer diameter max. mm	Bending radius fixed min. mm	Bending radius free moving min. mm	Weight (approx.) kg/km	Permissible tensile force max. N	Conductor resistance at 20°C max. Ω/km	Nominal operating capacitance μF/km	Inductance nom. mH/km	Current carrying capacity (1) A	Short Circuit Current (conductor) kA
4x35	20004845	5DL1414	7.5	32.1	35.1	140	176	2200	2100	0.554	0.49	0.25	162	5.01
4x50	20004846	5DL1415	8.8	38.2	41.2	165	206	3050	3000	0.386	0.51	0.25	202	7.15
4x70	20004847	5DL1416	10.6	42.5	45.5	182	228	3980	4200	0.272	0.59	0.24	250	10.01
4x95	20004848	5DL1417	12.1	48.3	52.3	209	262	5220	5700	0.206	0.6	0.24	301	13.59
4x120	20016763	5DL1418	14.2	54.8	58.8	235	294	6690	7200	0.161	0.69	0.23	352	17.16
4x150	20023637	5DL1420	16.1	60.2	64.2	257	321	8140	9000	0.129	0.7	0.23	404	21.45
4x185	20007494	5DL1421	17.9	67.3	71.3	285	357	10010	11100	0.106	0.71	0.23	461	26.46
4x240	20060343	5DL1422	20.3	72.4	76.4	306	382	12240	14400	0.0801	0.73	0.23	540	34.32
PROTOMONT NSSHÖU-J 3x.../...														
3x50/25	20004863	5DL1715	8.8	38.2	41.2	165	206	2890	3000	0.386	0.51	0.25	202	7.15
3x70/35	20004864	5DL1716	10.6	42.5	45.5	182	228	3750	4200	0.272	0.59	0.24	250	10.01
3x95/50	20004865	5DL1717	12.1	48.3	52.3	209	262	4940	5700	0.206	0.6	0.24	301	13.59
3x120/70	20004866	5DL1718	14.2	54.8	58.8	235	294	6380	7200	0.161	0.69	0.23	352	17.16
3x150/70	20004868	5DL1722	16.1	60.2	64.2	257	321	7660	9000	0.129	0.7	0.23	404	21.45
3x185/95	20004867	5DL1721	17.9	67.3	71.3	285	357	9490	11100	0.106	0.71	0.23	461	26.46
3x240/120	20196331	5DL1745	20.2	72.4	76.4	306	382	11620	14400	0.08	0.73	0.23	540	34.32
PROTOMONT NSSHÖU-J 3x...+3x.../3														
3x185+3x95/3		5DL1973	17.9	60.7	64.7	259	324	8690	8325	0.106	0.71	0.23	461	26.46
PROTOMONT NSSHÖU-J 5x...														
5x1,5	20004855	5DL1504	1.6	12.4	14	56	70	250	113	13.3	0.22	0.33	23	0.21
5x2,5	20004856	5DL1505	1.9	14.7	16.7	67	84	370	188	7.98	0.23	0.32	30	0.36
5x4	20004857	5DL1506	2.4	16.5	18.5	74	93	490	300	4.95	0.26	0.31	41	0.57
5x6	20004858	5DL1507	2.9	18.6	20.6	82	103	650	450	3.3	0.3	0.29	53	0.86
5x10	20004859	5DL1510	3.9	22.5	24.5	98	123	980	750	1.91	0.32	0.28	74	1.43
5x16	20004860	5DL1512	5.4	26.7	29.7	119	149	1420	1200	1.21	0.42	0.26	99	2.29
5x25	20004861	5DL1513	6.3	31.8	34.8	139	174	2080	1875	0.7839	0.42	0.26	131	3.58
5x35	20006970	5DL1514	7.5	37.1	40.1	160	201	2760	2625	0.554	0.49	0.25	162	5.01
5x50	20024298	5DL1519	8.8	46.4	44.5	178	223	3670	3750	0.386	0.51	0.25	202	7.15
5x70	20024963	5DL1516	10.6	47	51	204	255	5050	5250	0.272	0.57	0.24	250	10.01
5x95	20023910	5DL1517	12.1	53.4	57.4	230	287	6450	7125	0.206	0.65	0.24	301	13.59
5x120	20023647	5DL1518	14.1	59.6	63.6	254	318	8130	9000	0.161	0.68	0.24	352	17.16
5x185	20211472	5DL1***	17.8	74.6	78.7	315	394	12010	13875	0.106	0.71	0.23	461	26.46
5x240	20062184	5DL1521	20.2	79.9	84.9	340	425	15430	18000	0.08	0.73	0.23	540	34.32
PROTOMONT NSSHÖU-J ...x1,5														
7x1,5	20004891	5DL1933	1.6	14.9	16.9	68	85	380	158	13.3	0.22	0.33	23	0.21
8x1,5	20004890	5DL1931	1.6	16.1	18.1	72	91	430	180	13.3	0.22	0.33	23	0.21
10x1,5	20004886	5DL1879	1.6	17.7	19.7	79	99	470	225	13.3	0.22	0.33	23	0.21
12x1,5	20023911	5DL1777	1.6	13	20.3	81	102	560	270	13.3	0.22	0.33	23	0.21
7x10+5x1,5ST	20004896	5DL1962	3.9	26	29	116	145	1460	1050	1.91	0.33	0.28	74	1.43
19x1,5	20023912	5DL1859	1.6	19.7	23.7	95	119	790	428	13.3	0.22	0.33	23	0.21
24x1,5	20088402	5DL1907	1.6	24.3	27.3	109	137	950	540	13.3	0.22	0.33	23	0.21
PROTOMONT NSSHÖU-J ...x2,5														
7x2,5	20004887	5DL1911	1.9	16.9	18.9	76	95	500	263	7.98	0.24	0.32	30	0.36
10x2,5	20174408	5DL1748	2	22.6	23.6	94	118	650	375	7.98	0.24	0.32	30	0.36

(1) Nominal current carrying capacity for rubber cables laid on a surface, at 30°C ambient temperature (see also VDE 0298-4, Table 15). For derating-factors see tables in Technical Appendix

Special designs available upon request, e.g.:

- special black outer sheath for -45°C
- halogen-free version with 5GM3 outer sheath

Continued from previous page.

PROTOMONT NSSHOEU 0.6/1 kV

Number of cores x cross section	Part number	MLFB Number	Conductor diameter max. mm	Outer diameter min. mm	Outer diameter max. mm	Bending radius fixed min. mm	Bending radius free moving min. mm	Weight (approx.) kg/km	Permissible tensile force max. N	Conductor resistance at 20°C max. Ω/km	Nominal operating capacitance μF/km	Inductance nom. mH/km	Current carrying capacity (1) A	Short Circuit Current (conductor) kA
12x2,5	20004874	5DL1755	1.9	20.7	22.7	91	114	750	450	7.98	0.24	0.32	30	0.36
18x2,5	20004892	5DL1937	1.9	24.5	27.5	110	138	1070	675	7.98	0.24	0.32	30	0.36
19x2,5	20025547	5DL1860	2	26	28	112	140	1140	713	7.98	0.24	0.32	30	0.36
24x2,5	20171197	5DL1842	1.9	27.6	30.6	122	153	1360	900	7.98	0.23	0.32	30	0.36
PROTOMONT NSSHÖU-J ...x4														
7x4	20059552	5DL1750	2.4	20	22	88	110	710	420	4.95	0.26	0.31	41	0.57
12x4	20040505	5DL1957	2.4	23.5	26.5	106	133	1060	720	4.95	0.26	0.31	41	0.57
7x4+5x1,5ST	20004893	5DL1938	2.4	23.5	25.5	102	128	940	420	4.95	0.26	0.31	41	0.57

(1) Nominal current carrying capacity for rubber cables laid on a surface, at 30°C ambient temperature (see also VDE 0298-4, Table 15). For derating-factors see tables in Technical Appendix
 Special designs available upon request, e.g.:
 - special black outer sheath for -45°C
 - halogen-free version with 5GM3 outer sheath

PROTOMONT NSHXOEU 1 kV

Flexible rubber cables for use in mining and industries



Application

For flexible use and fixed installation in underground mining applications, tunnel building applications, open-cast mining applications, in quarries, on construction sites and similar applications, with medium mechanical stresses. The cables can be used indoors as well as outdoors, in explosion-hazard areas, in industry and in agriculture. They can be used permanently in waste water up to 40 °C. The cables can also be used in industrial water, cooling water, surface water, rainwater and mixed water - and in groundwater and seawater to a more limited extent. The requirements for accessibility and inspection are less stringent in such cases at depths greater than 10 m up to 500 m. In other respects the specifications of DIN VDE 0298 part 3 apply.

Global data

Brand	PROTOMONT
Type designation	NSHXOEU
Standard	Based on DIN VDE 0250 part 812

Notes on installation

Maximum Submersing Depth	500 Meter
--------------------------	-----------

Design features

Conductor	Copper, tinned, finely stranded (class 5) in accordance with DIN VDE 0295 / IEC 60228
Insulation	PROTOLON, Basic material: EPR, Compound type: 3GI3, in accordance with DIN VDE 0207
Core identification	Up to 5 cores: colored in accordance with DIN VDE 0293-308 from 6 cores: light with black numbers
Inner sheath	Vulcanized rubber compound, Basic material: EPR, Compound type: GM1B, in accordance with DIN VDE 0207 (not for single-core cables)
Outer sheath	Vulcanized rubber compound, basis EVA, compound 5GM3 in accordance with DIN VDE 0207 Colour: yellow

Electrical parameters

Rated voltage	0.6/1 kV (600/1000V)
Max. permissible operating voltage AC	0.7/1.2 kV
Max. permissible operating voltage DC	0.9/1.8 kV
AC test voltage - main cores	3 kV (5 Min.)
AC test voltage - control cores	2 kV

Chemical parameters

Flame propagation	DIN EN 60332-1-2
Resistance to oil	DIN EN 60811-2-1
Water resistance	EN 50525-2-21

Thermal parameters

Max. operating temperature of the conductor	90 °C
Max. short circuit temperature of the conductor	250 °C
Max. permissible water temperature	40 °C (At higher water temperatures, a shortened cable service life is to be expected)
Ambient temperature for fixed installation	min -40 °C ; max +80 °C
Ambient temperature in fully flexible operation	min -25 °C ; max +60 °C

Mechanical parameters

Max. tensile load on the conductor	15 N/mm ²
Bending radii min.	Acc. to DIN VDE 0298 part 3

PROTOMONT NSHXOEU 0.6/1 kV

Number of cores x cross section	Part number	MLFB Number	Conductor diameter max. mm	Outer diameter min. mm	Outer diameter max. mm	Bending radius fixed min. mm	Weight (approx.) kg/km	Permissible tensile force max. N	Conductor resistance at 20°C max. Ω/km	Nominal operating capacitance μF/km	Inductance nom. mH/km	Current carrying capacity (1) A	Short Circuit Current (conductor) kA
PROTOMONT NSHXOEU-O 1x...													
1x300	20216518	5DL4850	22.9	34.5	36.8	147	3330	4500	0.0654	0.76	0.23	843	42.9
1x400	20216519	5DL4***	26.2	38.5	40.5	162	4210	6000	0.0495	0.76	0.24	1024	57.2
PROTOMONT NSHXOEU-J 3x...													
3x2,5	20156737	5DL4816	2	12	13.6	54	250	113	8.21	0.23	0.32	30	0.36
PROTOMONT NSHXOEU-J 3x.../...													
3x50/25	20121240	5DL4800	8.8	38.1	41.1	164	2930	3000	0.393	0.5	0.25	202	7.15
3x70/35	20121239	5DL4801	10.6	42.3	45.3	181	3790	4200	0.277	0.59	0.24	250	10.01
3x95/50	20057423	5DL4802	12.1	48.2	52.2	209	5170	5700	0.21	0.6	0.24	301	13.59
3x120/70			14.2	54.6	58.6	234	6482	7200	0.164	0.69	0.23	352	17.16
3x150/70			16.1	60	64	256	7568	9000	0.132	0.7	0.23	404	21.45
3x185/95			17.9	67.3	71.3	285	9328	11100	0.108	0.71	0.23	461	26.46
PROTOMONT NSHXOEU-J 4x...													
4x2,5	20153827	5DL4***	2	14.2	16	64	310	150	8.21	0.23	0.32	30	0.36
PROTOMONT NSHXOEU-J 5x...													
5x1,5			1.6	12.7	14.3	57	250	113	13.7	0.22	0.33	23	0.21
5x2,5	20156738	5DL4815	2	14.7	16.7	67	380	188	8.21	0.23	0.32	30	0.36
5x4	20156739	5DL4814	2.4	16.5	18.5	74	500	300	5.09	0.26	0.31	41	0.57
5x6	20121283	5DL4810	2.9	18.6	20.6	82	660	450	3.39	0.3	0.29	53	0.86
5x10	20121282	5DL4811	3.9	22.5	24.5	98	1000	750	1.95	0.32	0.28	74	1.43
5x16	20156740	5DL4813	5.4	26.7	29.7	119	1440	1200	1.24	0.42	0.26	99	2.29
5x25	20121281	5DL4812	6.3	31.7	34.7	139	2110	1875	0.795	0.42	0.26	131	3.58
5x35			7.5	36.9	39.9	160	2743	2625	0.565	0.49	0.25	162	5.01

(1) Nominal current carrying capacity for rubber cables laid on a surface, at 30°C ambient temperature (see also VDE 0298-4, Table 15). For derating-factors see tables in Technical Appendix

PROTOMONT(MT) (N)SHOEU 1 kV

Low Voltage light and flexible rubber cable



Application

Rubber-sheathed flexible cables for mining application, suitable for laying alongside conveyor belts (also for shiftable units), on material handling equipment and for tunneling sites, under heavy mechanical stress, e.g. in cable suspension fittings and as connection between upper and lower cars. The cables can be used indoors as well as outdoors, in explosion-hazard areas, in industry and in agriculture. The cables are water resistant and also suitable for connection of submersible pump units. In other respects the specifications of DIN VDE 0298 part 3 applies.

Global data

Brand	PROTOMONT(MT)
Type designation	(N)SHOEU
Standard	Based on DIN VDE 0250 part 812
Certifications / Approvals	VDE certificate with factory surveillance

Notes on installation

Notes on installation	max. depth 500m
-----------------------	-----------------

Design features

Conductor	Bare electrolytic copper, finely stranded (class 5)
Insulation	PROTOLON, Basic material: EPR, Compound type: Special compound better 3GI3
Core identification	Light gray with black digits
Screen	In case of concentric screen (KON types only): closed layer of copper wire spinning over core assembly
Inner sheath	Basic material: EPR, Compound type: Special compound
Outer sheath	Basic material: Chlorinated rubber, Compound type: Special compound, 5GM5 Colour: yellow

Electrical parameters

Rated voltage	0.6/1 kV (600/1000V)
Max. permissible operating voltage AC	0.7/1.2 kV
Max. permissible operating voltage DC	0.9/1.8 kV
AC test voltage - main cores	3,5 kV (5 Min.)
AC test voltage - control cores	2 kV

Chemical parameters

Performance against fire	IEC 60332-1-2
Resistance to oil	IEC 60811-404
Weather resistance	Unrestricted use outdoors and indoors, resistant to ozone and moisture
Water resistance	EN 50525-2-21

Thermal parameters

Max. operating temperature of the conductor	90 °C
Max. short circuit temperature of the conductor	250 °C
Max. permissible water temperature	40 °C (At higher water temperatures, a shortened cable service life is to be expected)
Ambient temperature for fixed installation	min -40 °C ; max +80 °C
Ambient temperature in fully flexible operation	min -25 °C ; max +60 °C

Mechanical parameters

Max. tensile load on the conductor	15 N/mm ²
Torsional stress +/-	100 °/m
Bending radii min.	Acc. to DIN VDE 0298 part 3
Travel speed	Max. speed on rewinding with drum car: 60 m/min

PROTOMONT(MT) (N)SHOEU 0.6/1 kV

Number of cores x cross section	Part number	MLFB Number	Conductor diameter max. mm	Outer diameter min. mm	Outer diameter max. mm	Weight (approx.) kg/km	Permissible tensile force max. N	Conductor resistance at 20°C max. Ω/km	Nominal operating capacitance μF/km	Inductance nom. mH/km	Current carrying capacity (1) A	Short Circuit Current (conductor) kA
PROTOMONT(MT) (N)SHOEU-O												
1x16	20265363	5DL4***	5.2	9.5	11.1	230	240	1.21	0.44	0.26	99	2.29
1x25	20265364	5DL4***	6.4	11	12.6	335	375	0.78	0.45	0.26	131	3.58
1x35	20265365	5DL4***	7.5	12.3	13.9	435	525	0.554	0.52	0.25	162	5.01
1x50	20265366	5DL4***	9	14.5	16.5	615	750	0.386	0.54	0.25	202	7.15
1x70	20265367	5DL4***	11.1	16.4	18.4	830	1050	0.272	0.61	0.24	250	10.01
1x95	20265369	5DL4***	12.8	18.5	20.5	1060	1425	0.206	0.64	0.24	301	13.59
1x120	20265370	5DL4***	14.5	20.4	22.4	1300	1800	0.161	0.72	0.23	352	17.16
1x150	20265372	5DL4***	16.5	22.8	24.8	1600	2250	0.129	0.72	0.23	404	21.45
1x185	20265373	5DL4***	17.9	24.7	27.7	2020	2775	0.106	0.71	0.23	461	26.46
1x240	20265374	5DL4***	21.2	27.6	30.6	2548	3600	0.08	0.76	0.23	540	34.32
1x300	20265377	5DL4***	23.6	31.6	34.6	3200	4500	0.0641	0.78	0.23	620	42.9
PROTOMONT(MT) (N)SHOEU-O												
2x1,5	20265378	5DL4***	1.6	9.8	11.4	150	45	13.3	0.21	0.33	23	0.18
2x2,5	20265379	5DL4***	2	10.7	12.3	185	75	7.98	0.24	0.32	30	0.31
2x4		5DL4	2.4	11.9	13.5	220	120	4.95	0.27	0.3	41	0.57
PROTOMONT(MT) (N)SHOEU-O												
3x2,5	20265395	5DL4***	2	11.1	12.7	210	113	7.98	0.24	0.32	30	0.31
3x4	20265396	5DL4***	2.4	12.1	13.7	271	180	4.95	0.27	0.3	41	0.57
3x6	20265397	5DL4***	2.9	13.2	14.8	350	270	3.3	0.32	0.29	53	0.86
3x10	20265398	5DL4***	3.9	16.1	18.1	505	450	1.91	0.34	0.28	74	1.43
3x16	20265399	5DL4***	5.2	19	21	775	720	1.21	0.44	0.26	99	2.29
3x25	20265400	5DL4***	6.4	22.9	24.9	1160	1125	0.78	0.45	0.26	131	3.58
3x35	20265401	5DL4***	7.5	24.9	27.9	1550	1575	0.554	0.52	0.25	162	5.01
3x50	20265402	5DL4***	9	29.4	32.4	2180	2250	0.386	0.54	0.25	202	7.15
3x70	20265403	5DL4***	11.1	34.8	37.8	3020	3150	0.272	0.61	0.24	250	10.01
3x95	20265405	5DL4***	12.8	40.9	43.9	3810	4275	0.206	0.64	0.24	301	13.59
3x120	20265406	5DL4***	14.4	44.7	47.7	4970	5400	0.161	0.72	0.23	352	17.16
3x150	20265407	5DL4***	16.1	50	54	6290	6750	0.129	0.72	0.23	404	21.45
3x185	20265408	5DL4***	17.9	54.6	58.6	7470	8325	0.106	0.95	0.22	461	26.46
PROTOMONT(MT) (N)SHOEU-J												
3x1,5	20265409	5DL4***	1.6	10.2	11.8	170	68	13.3	0.21	0.33	23	0.18
3x2,5	20265410	5DL4***	2	11.1	12.7	220	113	7.98	0.24	0.32	30	0.31
3x4	20265411	5DL4***	2.4	12.1	13.7	290	180	4.95	0.27	0.31	41	0.57
3x6	20265412	5DL4***	2.9	13.2	14.8	360	270	3.3	0.32	0.29	53	0.86
PROTOMONT(MT) (N)SHOEU-J												
4x1,5	20265413	5DL4***	1.6	11	12.6	204	90	13.3	0.21	0.33	23	0.18
4x2,5	20265414	5DL4***	2	12	13.6	270	150	7.98	0.24	0.32	30	0.31
4x4	20265415	5DL4***	2.4	13	14.6	338	240	4.95	0.27	0.3	41	0.57
4x6	20265416	5DL4***	2.9	14.9	16.9	450	360	3.3	0.32	0.29	53	0.86
4x10	20265417	5DL4***	3.9	17.4	19.4	690	600	1.91	0.34	0.28	74	1.43
4x16	20265418	5DL4610	5.2	21	23	980	960	1.21	0.44	0.26	99	2.29
4x25	20265419	5DL4***	6.4	24.5	27.5	1490	1500	0.78	0.45	0.26	131	3.58
4x35	20265420	5DL4***	7.5	28.4	31.4	1870	2100	0.554	0.52	0.25	162	5.01

(1) Nominal current carrying capacity for rubber cables laid on a surface, at 30°C ambient temperature (see also VDE 0298-4, Table 15). For derating-factors see tables in Technical Appendix
Halogen-free version with 5GM3 outer sheath available on request

Continued from previous page.

PROTOMONT(MT) (N)SHOEU 0.6/1 kV

Number of cores x cross section	Part number	MLFB Number	Conductor diameter max. mm	Outer diameter min. mm	Outer diameter max. mm	Weight (approx.) kg/km	Permissible tensile force max. N	Conductor resistance at 20°C max. Ω/km	Nominal operating capacitance μF/km	Inductance nom. mH/km	Current carrying capacity (1) A	Short Circuit Current (conductor) kA
4x50	20265421	5DL4***	9	33.6	36.6	2570	3000	0.386	0.54	0.25	202	7.15
4x70	20265423	5DL4***	10.6	39.5	42.5	3920	4200	0.272	0.61	0.24	250	10.01
4x95	20265424	5DL4***	12.8	44.8	47.8	5040	5700	0.206	0.64	0.24	301	13.59
4x120	20265425	5DL4613	14.4	49.8	53.8	6200	7200	0.161	0.72	0.23	352	17.16
4x150		5DL4	16.1	54.9	58.9	7578	9000	0.129	0.72	0.23	404	21.45
PROTOMONT(MT) (N)SHOEU-J												
3x50+3x25/3	20278765	5DL4***	9	29.4	32.4	2350	2250	0.386	0.54	0.25	202	7.15
3x70+3x35/3	20268926	5DL4614	10.6	35.1	38.1	3220	3150	0.272	0.61	0.24	250	10.01
3x95/50	20220195	5DL4***	12.1	44.8	47.8	4400	4275	0.206	0.6	0.24	301	13.59
3x95+3x50/3	20268927	5DL4615	12.8	40.7	43.7	4300	4275	0.206	0.64	0.24	301	13.59
3x120+3x70/3	20268929	5DL4616	14.4	44.5	47.5	5370	5400	0.161	0.72	0.23	352	17.16
3x150+3x70/3	20278766	5DL4***	16.5	51.6	55.6	6950	6750	0.129	0.72	0.23	404	21.45
3x185+3x95/3	20278767	5DL4***	17.9	54.5	58.5	8150	8325	0.106	0.71	0.23	461	26.46
3x240+3x120/3	20278768	5DL4***	20.6	62.2	66.2	10700	10800	0.08	0.76	0.23	540	34.32
3x300+3x150/3	20278769	5DL4***	23.4	70.3	74.3	13300	13500	0.064	0.78	0.23	620	42.9
PROTOMONT(MT) (N)SHOEU-J												
5x1,5	20278770	5DL4***	1.6	11.9	13.5	240	113	13.3	0.21	0.33	23	0.18
5x2,5	20278771	5DL4***	2	12.9	14.5	310	188	7.98	0.24	0.32	30	0.31
5x4	20268918	5DL4605	2.4	14.7	16.7	420	300	4.95	0.27	0.3	41	0.57
5x6	20268919	5DL4606	2.9	16.1	18.1	530	450	3.3	0.32	0.29	53	0.86
5x10	20268772	5DL4	3.9	19	21	795	750	1.91	0.34	0.28	74	1.43
5x16	20268920	5DL4607	5.2	22.8	24.8	1180	1200	1.21	0.44	0.26	99	2.29
5x25	20278773	5DL4***	6.4	28	31	1880	1875	0.78	0.45	0.26	131	3.58
5x35	20278774	5DL4***	7.5	34.5	37.5	2650	2625	0.554	0.46	0.25	162	5.01
PROTOMONT(MT) (N)SHOEU-O Control cables												
12x4	20278807	5DL4***	2.4	20.8	22.8	870	720	4.95	0.27	0.3	41	0.57
12x6	20278808	5DL4***	2.9	23.4	26.4	1150	1080	3.3	0.32	0.29	53	0.86
PROTOMONT(MT) (N)SHOEU-J Control cables												
7x1,5	20278776	5DL4***	1.6	12.9	14.5	300	158	13.3	0.21	0.33	23	0.18
8x1,5		5DL4	1.6	13.8	15.4	325	180	13.3	0.21	0.33	23	0.18
10x1,5		5DL4	1.6	15.5	17.5	400	225	13.3	0.21	0.33	23	0.18
12x1,5	20278777	5DL4***	1.6	15.8	17.8	500	270	13.3	0.21	0.33	23	0.18
14x1,5		5DL4	1.6	16.8	18.8	495	315	13.3	0.21	0.33	23	0.18
18x1,5	20278778	5DL4***	1.6	18.5	20.5	610	405	13.3	0.21	0.33	23	0.18
19x1,5	20278779	5DL4***	1.6	18.9	20.9	650	428	13.3	0.21	0.33	23	0.18
24x1,5	20278780	5DL4***	1.6	20	22	800	540	13.3	0.21	0.33	23	0.18
7x2,5	20278801	5DL4***	2	14.9	16.9	450	263	7.98	0.24	0.32	30	0.31
8x2,5	20278802	5DL4***	2	15.8	17.8	480	300	7.98	0.24	0.32	30	0.31
10x2,5		5DL4	2	16.4	18.4	500	375	7.98	0.24	0.32	30	0.31
12x2,5	20278803	5DL4***	2	18	20	600	450	7.98	0.24	0.32	30	0.31
15x2,5	20278804	5DL4***	2	20.7	22.7	780	563	7.98	0.24	0.32	30	0.31
18x2,5	20278805	5DL4***	2	21.2	23.2	850	675	7.98	0.24	0.32	30	0.31
19x2,5		5DL4	2	22.3	24.3	900	713	7.98	0.24	0.32	30	0.31
24x2,5	20278806	5DL4***	2	22.8	24.8	1070	900	7.98	0.24	0.32	30	0.31

(1) Nominal current carrying capacity for rubber cables laid on a surface, at 30°C ambient temperature (see also VDE 0298-4, Table 15). For derating-factors see tables in Technical Appendix
Halogen-free version with SGM3 outer sheath available on request

Continued from previous page.

PROTOMONT(MT) (N)SHOEU 0.6/1 kV

Number of cores x cross section	Part number	MLFB Number	Conductor diameter max. mm	Outer diameter min. mm	Outer diameter max. mm	Weight (approx.) kg/km	Permissible tensile force max. N	Conductor resistance at 20°C max. Ω/km	Nominal operating capacitance μF/km	Inductance nom. mH/km	Current carrying capacity (1) A	Short Circuit Current (conductor) kA
37x2,5		5DL4	2	29	31	1600	1388	7.98	0.24	0.32	30	0.31
PROTOMONT(MT) (N)SHOEU-J... KON Control cables												
3x0,75/0,75KON			1.1	6.6	7.6	96	34	26	0.27	0.29	8	0.11
18x1,5/1,5KON			1.6	22	24	720	405	13.3	0.21	0.33	23	0.18
4x1,5/1,5KON			1.6	13	14.6	280	90	13.3	0.19	0.35	23	0.18
7x1,5/4KON			1.6	15.5	17.5	360	158	13.3	0.21	0.33	23	0.18
9x1,5/4KON			1.6	17.5	19.5	430	203	13.3	0.21	0.33	23	0.18
12x1,5/4KON			1.6	18	20	517	270	13.3	0.21	0.33	23	0.18
15x1,5/4KON			1.6	21	23	600	338	13.3	0.21	0.33	23	0.18
19x1,5/4KON			1.6	22	24	700	428	13.3	0.21	0.33	23	0.18
7x2,5/2,5KON			2	14	15.6	418	263	7.98	0.24	0.32	30	0.31
12x2,5/2,5KON			2	16	18	630	450	7.98	0.24	0.32	30	0.31

(1) Nominal current carrying capacity for rubber cables laid on a surface, at 30°C ambient temperature (see also VDE 0298-4, Table 15). For derating-factors see tables in Technical Appendix
Halogen-free version with 5GM3 outer sheath available on request

PROTOMONT EMV-FC (N)SSHCOEU 1 kV

Cables for Variable Frequency Converter



Application

The cables are suitable for fixed installation and flexible operation as motor power supply cables for frequency converter controlled drives in the mining industry, on construction sites and similar applications, with heavy mechanical stresses. For laying on material handling equipment (even with continuous movement such as in cable booms or as connection between upper and lower car). Can be applied in water up to 40°C, approximately up to 10 m depth.

Global data

Brand	PROTOMONT EMV-FC
Type designation	(N)SSHCOEU
Standard	Based on DIN VDE 0250 part 812
Certifications / Approvals	MSHA P-189-3 EAC Certificate

Design features

Conductor	Finely stranded copper conductor, tinned (class 5) according to DIN EN 60228
Insulation	PROTOLON, Basic material: EPR, Compound type: 3GI3
Core identification	Natural coloring with black figures
Core arrangement	Three power cores laid up with the protective earth conductors split into three in the outer interstices
Screen	EMC optimized, concentric braid of tinned copper wires
Inner sheath	Vulcanized rubber compound, Basic material: EPR, Compound type: GM1B
Outer sheath	PROTOFIRM, synthetic elastomer compound e.g. CR, Compound type: 5GM5, Color: Yellow

Electrical parameters

Rated voltage	U ₀ /U = 0,6/1 kV, also permitted for U ₀ /U = 640/1140V
Max. permissible operating voltage AC	0.7/1.2 kV
Max. permissible operating voltage DC	0.9/1.8 kV
AC test voltage - main cores	5 kV (5 Min.)

Chemical parameters

Performance against fire	IEC 60332-1-2
Resistance to oil	IEC 60811-404
Weather resistance	Unrestricted use outdoors and indoors, resistant to ozone and moisture

Thermal parameters

Max. operating temperature of the conductor	90 °C
Max. short circuit temperature of the conductor	250 °C
Ambient temperature for fixed installation	min -40 °C ; max +80 °C
Ambient temperature in fully flexible operation	min -25 °C ; max +60 °C

Mechanical parameters

Max. tensile load on the conductor	15 N/mm ²
Torsional stress +/-	25 °/m
Bending radii min.	Acc. to DIN VDE 0298 part 3

PROTOMONT EMV-FC (N)SSHCOEU 0.6/1 kV

Number of cores x cross section	Part number	MLFB Number	Conductor diameter max. mm	Outer diameter min. mm	Outer diameter max. mm	Weight (approx.) kg/km	Permissible tensile force max. N	Conductor resistance at 20°C max. Ω/km	Nominal operating capacitance μF/km	Inductance nom. mH/km	Current carrying capacity (1) A	Short Circuit Current (conductor) kA
3x16+3x2,5	20004904	5DL2108	5.4	24.4	27.4	1190	720	1.24	0.42	0.26	99	2.29
3x25+3x4	20016716	5DL2107	6.3	28.2	31.2	1680	1125	0.795	0.42	0.26	131	3.58
3x35+3x16/3	20004903	5DL2106	7.5	30.5	33.5	2000	1575	0.565	0.49	0.25	162	5.01
3x50+3x25/3	20004902	5DL2105	8.9	36	39	2820	2250	0.393	0.51	0.25	202	7.15
3x70+3x35/3	20004901	5DL2104	10.6	41.2	44.2	3800	3150	0.277	0.59	0.24	250	10.01
3x95+3x50/3	20004900	5DL2103	12.1	45.7	48.7	4760	4275	0.21	0.6	0.24	301	13.59
3x120+3x70/3	20001453	5DL2100	14.1	48.7	52.7	5890	5400	0.164	0.69	0.23	352	17.16
3x150+3x70/3	20004899	5DL2101	16	55.7	59.7	7230	6750	0.132	0.7	0.23	404	21.45
3x185+3x95/3	20004905	5DL2109	17.8	60.4	64.4	8640	8325	0.108	0.71	0.23	461	26.46
3x240+3x120/3	20008903	5DL2102	20.2	68.2	72.2	11100	10800	0.0817	0.73	0.23	540	34.32

(1) Nominal current carrying capacity for rubber cables laid on a surface, at 30°C ambient temperature (see also VDE 0298-4, Table 15). For derating-factors see tables in Technical Appendix

PROTOMONT EMV-FC (N)SSHCOEU (-45°C) 1 kV

Cables for Variable Frequency Converter



Application

The cables are suitable for fixed installation and flexible operation as motor power supply cables for frequency converter controlled drives in the mining industry, on construction sites and similar applications, with heavy mechanical stresses. For laying on material handling equipment (even with continuous movement such as in cable booms or as connection between upper and lower car). Can be applied in water up to 40°C, approximately up to 10 m depth.

Global data

Brand	PROTOMONT EMV-FC
Type designation	(N)SSHCOEU
Standard	Based on DIN VDE 0250 part 812
Certifications / Approvals	MSHA P-189-3 EAC Certificate

Design features

Conductor	Finely stranded copper conductor, tinned (class 5)
Insulation	PROTOLON, Basic material: EPR, Compound type: 3GI3
Core identification	Natural coloring with black figures
Core arrangement	Three power cores laid-up with the protective earth conductors split into three in the outer interstices
Screen	EMC optimized, concentric braid of tinned copper wires
Inner sheath	Vulcanized rubber compound, Basic material: EPR, Compound type: GM1B
Outer sheath	PROTOFIRM, synthetic elastomer compound e.g. CR, Compound type: 5GM5, Color: Black

Electrical parameters

Rated voltage	U ₀ /U = 0,6/1 kV, also permitted for U ₀ /U = 640/1140V
Max. permissible operating voltage AC	0.7/1.2 kV
Max. permissible operating voltage DC	0.9/1.8 kV
AC test voltage - main cores	5 kV (5 Min.)

Chemical parameters

Performance against fire	IEC 60332-1-2
Resistance to oil	IEC 60811-404
Weather resistance	Unrestricted use outdoors and indoors, resistant to ozone and moisture

Thermal parameters

Max. operating temperature of the conductor	90 °C
Max. short circuit temperature of the conductor	250 °C
Ambient temperature for fixed installation	min -60 °C ; max +80 °C
Ambient temperature in fully flexible operation	min -45 °C ; max +60 °C

Mechanical parameters

Max. tensile load on the conductor	15 N/mm ²
Torsional stress +/-	25 °/m
Bending radii min.	Acc. to DIN VDE 0298 part 3

PROTOMONT EMV-FC (N)SSHCOEU (-45°C) 0.6/1 kV

Number of cores x cross section	Part number	MLFB Number	Conductor diameter max. mm	Outer diameter min. mm	Outer diameter max. mm	Weight (approx.) kg/km	Permissible tensile force max. N	Conductor resistance at 20°C max. Ω/km	Nominal operating capacitance μF/km	Inductance nom. mH/km	Current carrying capacity (1) A	Short Circuit Current (conductor) kA
3x16+3x2,5			5.4	24.4	27.4	1200	720	1.24	0.42	0.26	99	2.29
3x25+3x4			6.3	28.2	31.2	1700	1125	0.795	0.42	0.26	131	3.58
3x35+3x16/3	20292045		7.5	30.5	33.5	2200	1575	0.565	0.49	0.25	162	5.01
3x50+3x25/3	20160629	5DL2135	8.9	36	39	2810	2250	0.393	0.51	0.25	202	7.15
3x70+3x35/3	20016544	5DL2134	10.6	41.2	44.2	3870	3150	0.277	0.59	0.24	250	10.01
3x95+3x50/3	20035936	5DL2133	12.1	45.7	48.7	4850	4275	0.21	0.6	0.24	301	13.59
3x120+3x70/3			14.1	48.7	52.7	5800	5400	0.164	0.69	0.23	352	17.16
3x150+3x70/3	20004907	5DL2131	16	55.7	59.7	7350	6750	0.132	0.7	0.23	404	21.45
3x185+3x95/3	20267596	5DL2139	17.8	60.4	64.4	8640	8325	0.108	0.71	0.23	461	26.46
3x240+3x120/3			20.2	65	71	11000	10800	0.0817	0.73	0.23	540	34.32

(1) Nominal current carrying capacity for rubber cables laid on a surface, at 30°C ambient temperature (see also VDE 0298-4, Table 15). For derating-factors see tables in Technical Appendix

FELTOFLEX NTMCW0EU 6 kV – 30 kV

Single core MV rubber cable, ultra-bendable



Application

These cables are intended for use as connection in switch-gear or transformer houses where a very small bending radius is required. These cables may be used in festoon systems up to a speed of 120 m/min. The preferred case due to the flexibility of the cable are shiftable units, big drivers, mobile transformers etc.

Global data

Brand	FELTOFLEX
Type designation	NTMCW0EU
Standard	DIN VDE 0250-813
Certifications / Approvals	Fire Certificate of Russian Federation GOST-R/-K/-B

Design features

Conductor	Copper tinned, finely stranded (class 5), according to DIN VDE 0295
Insulation	Rubber, compound type: EPR-3GI3
Electrical field control	Inner and outer layer of semiconductive rubber compound, cold strippable outer layer
Core identification	Acc. to DIN VDE 0250 P 813, Color: Natural
Screen	Spinning of tinned copper wires
Outer sheath	Rubber, compound type: 5GM5 acc. to DIN VDE 0207 part 21, Color: Red

Electrical parameters

Rated voltage	3.6/6 kV	6/10 kV
Max. permissible operating voltage AC	4.2/7.2 kV	6,9/12 kV
Max. permissible operating voltage DC	5.4/10.8 kV	9/18 kV
AC test voltage - main cores	11 kV (5 Min.)	17 kV (5 Min.)
Max. partial discharge intensity	IEC 60502-2, 1,75 x U ₀ , <10pC	IEC 60502-2, 1,75 x U ₀ , <10pC
	8.7/15 kV	12/20 kV
	10.4/18 kV	13.9/24 kV
	13.5/27 kV	18/36 kV
	24 kV (5 Min.)	29 kV (5 Min.)
	IEC 60502-2, 1,75 x U ₀ , <10pC	IEC 60502-2, 1,75 x U ₀ , <10pC
	14/25 kV	18/30 kV
	17.3/30 kV	20.8/36 kV
	22.5/45 kV	27/54 kV
	36 kV (5 Min.)	43 kV (5 Min.)
	IEC 60502-2, 1,75 x U ₀ , <10pC	IEC 60502-2, 1,75 x U ₀ , <10pC

Chemical parameters

Performance against fire	IEC 60332-1-2
Resistance to oil	IEC 60811-404
Weather resistance	Unrestricted use outdoors and indoors, resistant to ozone, UV, and moisture

Thermal parameters

Max. operating temperature of the conductor	90 °C
Max. short circuit temperature of the conductor	250 °C
Ambient temperature for fixed installation	min -40 °C ; max +80 °C
Ambient temperature in fully flexible operation	min -25 °C ; max +80 °C

Mechanical parameters

Max. tensile load on the conductor	15 N/mm ²
Torsional stress +/-	25 °/m
Bending radii min.	Acc. to DIN VDE 0298 part 3

FELTOFLEX NTMCW0EU 3.6/6 kV

Number of cores x cross section	Conductor diameter max. mm	Diameter over insulation (nom.) mm	Outer diameter min. mm	Outer diameter max. mm	Bending radius fixed min. mm	Bending radius free moving min. mm	Weight (approx.) kg/km	Permissible tensile force max. N	Conductor resistance at 20°C max. Ω/km	Nominal operating capacitance μF/km	Current carrying capacity (1) A	Short Circuit Current (conductor) kA
1x25/16KON	6.2	14.6	19.1	21.6	129.6	216	750	375	0.795	0.24	178	3.58
1x35/16KON	7.5	15.9	20.4	22.9	137.4	229	850	525	0.565	0.27	220	5.01
1x50/16KON	9	17.36	21.8	24.3	145.8	243	1000	750	0.393	0.3	275	7.15
1x70/16KON	10.6	19	23.5	26	156	260	1250	1050	0.277	0.34	340	10.01
1x95/16KON	12.6	21	26.1	28.6	171.6	286	1500	1425	0.21	0.38	409	13.59
1x120/16KON	14.8	23.2	28.1	30.6	183.6	306	1800	1800	0.164	0.43	479	17.16
1x150/25KON	16	24.4	29.4	31.9	191.4	319	2150	2250	0.132	0.46	549	21.45
1x185/25KON	17.7	26.1	32.2	34.7	208.2	347	2550	2775	0.108	0.5	627	26.46
1x240/25KON	20.3	28.7	34.8	37.3	223.8	373	3100	3600	0.0817	0.56	734	34.32
1x300/25KON	22.5	30.9	38	40.5	243	405	3750	4500	0.0654	0.61	843	42.9

FELTOFLEX NTMCW0EU 6/10 kV

Number of cores x cross section	Part number	Conductor diameter max. mm	Diameter over insulation (nom.) mm	Outer diameter min. mm	Outer diameter max. mm	Bending radius fixed min. mm	Bending radius free moving min. mm	Weight (approx.) kg/km	Permissible tensile force max. N	Conductor resistance at 20°C max. Ω/km	Nominal operating capacitance μF/km	Current carrying capacity (1) A	Short Circuit Current (conductor) kA
1x16/16KON	20203071	5.3	14.5	19	22	132	220	760	240	1.24	0.2	135	2.29
1x25/16KON	20171451	6.2	15.8	21.8	24.3	145.8	243	890	375	0.795	0.21	178	3.58
1x35/16KON	20076099	7.5	17.1	23.1	25.6	153.6	256	990	525	0.565	0.24	220	5.01
1x50/16KON	20074726	9	18.7	26.1	28.6	171.6	286	1260	750	0.393	0.26	275	7.15
1x70/16KON	20074263	10.6	20.5	28.3	30.8	184.8	308	1540	1050	0.277	0.29	340	10.01
1x95/16KON	20074265	12.6	22.3	29.4	31.9	191.4	319	1720	1425	0.21	0.34	409	13.59
1x120/16KON	20074724	14.8	24.2	31.6	34.1	204.6	341	2010	1800	0.164	0.39	479	17.16
1x150/25KON	20142777	16	25.9	33.3	35.8	214.8	358	2430	2250	0.132	0.4	549	21.45
1x185/25KON	20074821	17.7	27.7	35.1	37.6	225.6	376	2800	2775	0.108	0.42	627	26.46
1x240/25KON	20074284	20.3	29.5	38.7	41.2	247.2	412	3420	3600	0.0817	0.51	734	34.32
1x300/25KON	20131478	22.5	32.2	40.9	43.4	260.4	434	4100	4500	0.0654	0.53	843	42.9
1x400/35KON	20142778	26.5	34.9	44.3	47.3	283.8	473	5260	6000	0.05	0.7	1024	57.2
1x500/35KON	20088035	29.3	37.7	47.7	50.7	304.2	507	6260	7500	0.0391	0.76	1178	71.5
1x630/35KON	20142779	33.9	42.3	52.2	56.2	337.2	562	7930	9450	0.0292	0.87	1364	90.09

(1) Nominal current carrying capacity for single-core rubber cables laid on a surface, at 30°C ambient temperature. For derating-factors see tables in Technical Appendix

FELTOFLEX NTMCW0EU 8.7/15 kV

Number of cores x cross section	Part number	Conductor diameter max. mm	Diameter over insulation (nom.) mm	Outer diameter min. mm	Outer diameter max. mm	Bending radius fixed min. mm	Bending radius free moving min. mm	Weight (approx.) kg/km	Permissible tensile force max. N	Conductor resistance at 20°C max. Ω/km	Nominal operating capacitance μF/km	Current carrying capacity (1) A	Short Circuit Current (conductor) kA
1x25/16KON		6.2	20	24.6	27.1	162.6	271	1000	375	0.795	0.16	189	3.58
1x35/16KON		7.5	21.3	25.9	28.4	170.4	284	1150	525	0.565	0.18	234	5.01
1x50/16KON		9	22.9	27.3	29.8	178.8	298	1350	750	0.393	0.2	292	7.15
1x70/16KON		10.6	24.7	31.1	33.6	201.6	336	1650	1050	0.277	0.22	360	10.01
1x95/16KON		12.6	26.5	32	34.5	207	345	1900	1425	0.21	0.25	434	13.59
1x120/16KON		14.8	28.4	34.2	36.7	220.2	367	2200	1800	0.164	0.28	505	17.16
1x150/25KON		16	30.1	36.5	39	234	390	2700	2250	0.132	0.29	582	21.45
1x185/25KON		17.7	31.9	38.3	40.8	244.8	408	3050	2775	0.108	0.31	664	26.46
1x240/25KON		20.3	34	40.9	43.4	260.4	434	3600	3600	0.0817	0.36	781	34.32
1x300/25KON		22.5	35.2	43.1	45.6	273.6	456	4200	4500	0.0654	0.41	898	42.9
1x400/35KON		26.5	39.1	47	50	300	500	4620	6000	0.05	0.47	1074	57.2
1x500/35KON	20174427	29.3	41.9	49	52	312	520	4800	7500	0.0391	0.51	1224	71.5

FELTOFLEX NTMCW0EU 12/20 kV

Number of cores x cross section	Part number	Conductor diameter max. mm	Diameter over insulation (nom.) mm	Outer diameter min. mm	Outer diameter max. mm	Bending radius fixed min. mm	Bending radius free moving min. mm	Weight (approx.) kg/km	Permissible tensile force max. N	Conductor resistance at 20°C max. Ω/km	Nominal operating capacitance μF/km	Current carrying capacity (1) A	Short Circuit Current (conductor) kA
1x25/16KON	20091155	6.2	20	26.4	28.9	173.4	289	1090	375	0.795	0.16	189	3.58
1x35/16KON	20074729	7.5	21.3	27.6	30.1	180.6	301	1250	525	0.565	0.18	234	5.01
1x50/16KON	20074260	9	22.9	29.3	31.8	190.8	318	1460	750	0.393	0.2	292	7.15
1x70/16KON	20074256	10.6	24.7	33.5	36	216	360	1850	1050	0.277	0.22	360	10.01
1x95/16KON	20074253	12.6	26.5	34.6	37.1	222.6	371	2090	1425	0.21	0.25	434	13.59
1x120/16KON	20074727	14.8	28.4	36.4	38.9	233.4	389	2380	1800	0.164	0.28	505	17.16
1x150/25KON	20074259	16.2	30.1	38.9	41.4	248.4	414	2920	2250	0.132	0.29	582	21.45
1x185/25KON	20143211	17.7	31.9	40.1	42.6	255.6	426	3260	2775	0.108	0.31	664	26.46
1x240/25KON	20074267	20.3	34	43.3	45.8	274.8	458	3840	3600	0.0817	0.36	781	34.32
1x300/25KON	20087237	22.5	35.2	44.9	47.4	284.4	474	4470	4500	0.0654	0.41	898	42.9
1x400/35KON	20140653	26.5	39.1	48	52	312	520	5730	6000	0.05	0.47	1074	57.2
1x500/35KON	20142780	29.3	41.9	52	56	336	560	6720	7500	0.0391	0.51	1224	71.5
1x630/35KON	20087238	35.2	47.4	58.5	61.5	369	615	8660	9450	0.0292	0.53	1360	90.09

(1) Nominal current carrying capacity for single-core rubber cables laid on a surface, at 30°C ambient temperature. For derating-factors see tables in Technical Appendix

FELTOFLEX NTMCW0EU 14/25 kV

Number of cores x cross section	Part number	Conductor diameter max. mm	Diameter over insulation (nom.) mm	Outer diameter min. mm	Outer diameter max. mm	Bending radius fixed min. mm	Bending radius free moving min. mm	Weight (approx.) kg/km	Permissible tensile force max. N	Conductor resistance at 20°C max. Ω/km	Nominal operating capacitance μF/km	Current carrying capacity (1) A	Short Circuit Current (conductor) kA
1x25/16KON		6.2	21.4	29.2	31.7	190.2	317	1300	375	0.795	0.15	189	3.58
1x35/16KON		7.5	23.5	31.5	34	204	340	1500	525	0.565	0.16	234	5.01
1x50/16KON		9	24.96	32.9	35.4	212.4	354	1700	750	0.393	0.18	292	7.15
1x70/16KON		10.6	26.6	34.6	37.1	222.6	371	1950	1050	0.277	0.2	360	10.01
1x95/16KON		12.6	28.6	37.6	40.1	240.6	401	2300	1425	0.21	0.22	434	13.59
1x120/16KON	20170617	14.8	30.8	39.8	42.3	253.8	423	2850	1800	0.164	0.25	505	17.16
1x150/25KON		16	32	41.1	43.6	261.6	436	3050	2250	0.132	0.26	582	21.45
1x185/25KON		17.7	33.7	42.9	45.4	272.4	454	3450	2775	0.108	0.28	664	26.46
1x240/25KON		20.3	36.3	45.5	48	288	480	4050	3600	0.0817	0.31	781	34.32
1x300/25KON	20168352	22.5	38.8	48.7	51.2	307.2	512	4860	4500	0.0654	0.33	898	42.9
1x400/35KON		26.5	41.3	49.2	53.2	319.2	532	5300	6000	0.05	0.41	1074	57.2
1x500/35KON		29.3	44.1	52	56	336	560	5500	7500	0.0391	0.44	1224	71.5
1x630/35KON		33.9	48.7	56.6	60.6	363.6	606	5800	9450	0.0292	0.5	1360	90.09

FELTOFLEX NTMCW0EU 18/30 kV

Number of cores x cross section	Part number	Conductor diameter max. mm	Diameter over insulation (nom.) mm	Outer diameter min. mm	Outer diameter max. mm	Bending radius fixed min. mm	Bending radius free moving min. mm	Weight (approx.) kg/km	Permissible tensile force max. N	Conductor resistance at 20°C max. Ω/km	Nominal operating capacitance μF/km	Current carrying capacity (1) A	Short Circuit Current (conductor) kA
1x25/16KON	20196724	6.2	24.6	32.4	34.9	209.4	349	1520	375	0.795	0.14	189	3.58
1x35/16KON		7.5	25.9	33.7	36.2	217.2	362	1650	525	0.565	0.15	234	5.01
1x50/16KON	20216846	9	26.5	35.1	37.6	225.6	376	1910	750	0.393	0.17	292	7.15
1x70/16KON		10.6	29	37.8	40.3	241.8	403	2200	1050	0.277	0.18	360	10.01
1x95/16KON		12.6	31	39.8	42.3	253.8	423	2500	1425	0.21	0.2	434	13.59
1x120/16KON	20091156	14.8	33.2	42	44.5	267	445	3000	1800	0.164	0.22	505	17.16
1x150/25KON	20081589	16	34.6	43.5	46	276	460	3380	2250	0.132	0.23	582	21.45
1x185/25KON	20170101	17.7	36	45.1	47.6	285.6	476	3740	2775	0.108	0.25	664	26.46
1x240/25KON	20234523	20.3	38.7	48.7	51.2	307.2	512	4530	3600	0.0817	0.28	781	34.32
1x300/25KON	20259251	22.5	42.5	50.9	54.4	326.4	544	5050	4500	0.065	0.28	898	42.9
1x400/35KON	20174753	26.5	45.5	52.2	56.2	337	562	6340	6000	0.05	0.32	1074	57.2
1x500/35KON	20175568	29.3	47.7	56	60	360	600	7560	7500	0.0391	0.37	1224	71.5
1x630/35KON	20157481	36.2	53.4	62	66	396	660	9380	9450	0.0292	0.46	1360	90.09

(1) Nominal current carrying capacity for single-core rubber cables laid on a surface, at 30°C ambient temperature. For derating-factors see tables in Technical Appendix

PROTOLON NTMCGCWOEU 6 kV – 30 kV

Medium voltage flexible single-core cable



Application

In general single-core cables are used in short lengths e.g. for the connection of switchgear cubicles and for connection of mobile transformer substations to overhead lines. While laying and during operation, care should be taken to protect the cables against excessive mechanical stresses. Furthermore the general conditions in DIN VDE 0298-3 have to be applied.

Global data

Brand	PROTOLON
Type designation	NTMCGCWOEU
Standard	DIN VDE 0250-813
Certifications / Approvals	Fire Certificate of Russian Federation GOST-R/-K/-B

Design features

Conductor	Finely stranded copper conductor, tinned (class 5), acc. DIN VDE 0295/ IEC 60228
PE-Conductor	Spinning with tinned copper wires 16 mm ² or 25 mm ²
Insulation	PROTOLON, Basic material: EPR, Compound type: 3GI3, acc. DIN VDE 0207 Part 20
Electrical field control	Inner and outer layer of semiconductive rubber compound
Outer sheath	Special compound, Basic material: Chlorinated rubber, Compound type: 5GM3, Color: Red, acc. DIN VDE 0207 Part 21

Electrical parameters

Rated voltage	3.6/6 kV	6/10 kV	8.7/15 kV
Max. permissible operating voltage AC	4.2/7.2 kV	6.9/12 kV	10.4/18 kV
Max. permissible operating voltage DC	5.4/10.8 kV	9/18 kV	13.5/27 kV
AC test voltage	11 kV	17 kV	24 kV
	12/20 kV	14/25 kV	18/30 kV
	13.9/24 kV	17.3/30 kV	20.8/36 kV
	18/36 kV	22.5/45 kV	27/54 kV
	29 kV	36 kV	43 kV

Chemical parameters

Performance against fire	IEC 60332-1-2
Resistance to oil	IEC 60811-404
Weather resistance	Unrestricted use outdoors and indoors, resistant to ozone, UV, and moisture

Thermal parameters

Max. operating temperature of the conductor	90 °C
Max. short circuit temperature of the conductor	250 °C
Ambient temperature for fixed installation	min -40 °C ; max +80 °C
Ambient temperature in fully flexible operation	min -25 °C ; max +60 °C

Mechanical parameters

Max. tensile load on the conductor	15 N/mm ²
Torsional stress +/-	25 °/m
Bending radii min.	Acc. to DIN VDE 0298 part 3

PROTOLON NTMCGW0EU 3.6/6 kV

Number of cores x cross section	Part number	MLFB Number	Conductor diameter max. mm	Diameter over insulation (nom.) mm	Outer diameter min. mm	Outer diameter max. mm	Bending radius fixed min. mm	Bending radius free moving min. mm	Weight (approx.) kg/km	Permissible tensile force max. N	Conductor resistance at 20°C max. Ω/km	Nominal operating capacitance μF/km	Current carrying capacity (1) A	Short Circuit Current (conductor) kA
1x25/16KON		5DK3562	6.4	14	20.6	22.1	133	221	820	375	0.795	0.26	178	3.58
1x35/16KON			7.5	15.1	21.5	23	138	230	930	525	0.565	0.29	220	5.01
1x50/16KON			9	16.6	23	24.5	147	245	1110	750	0.393	0.33	275	7.15
1x70/16KON	20223892	5DK3***	10.8	18.4	25.1	27.4	164	274	1380	1050	0.277	0.38	340	10.01
1x95/16KON	20141681	5DK35	12.6	20.2	26.9	29.2	175	292	1630	1425	0.21	0.42	409	13.59
1x120/16KON	20001442	5DK3954	14.2	21.8	28.5	30.8	185	308	1940	1800	0.164	0.46	479	17.16
1x150/25KON	20004502	5DK3565	15.8	23.4	31.4	33.6	202	336	2410	2250	0.132	0.5	549	21.45
1x185/25KON	20004503	5DK3569	17.4	25	33	35.2	211	352	2750	2775	0.108	0.54	627	26.46
1x240/25KON	20001441	5DK3577	20.4	28.3	37.3	39.5	237	395	3430	3600	0.0817	0.6	734	34.32
1x300/25KON	20004504	5DK3578	22.9	30.5	39.5	41.7	250	417	4000	4500	0.0641	0.68	843	42.9

PROTOLON NTMCGW0EU 6/10 kV

Number of cores x cross section	Part number	MLFB Number	Conductor diameter max. mm	Diameter over insulation (nom.) mm	Outer diameter min. mm	Outer diameter max. mm	Bending radius fixed min. mm	Bending radius free moving min. mm	Weight (approx.) kg/km	Permissible tensile force max. N	Conductor resistance at 20°C max. Ω/km	Nominal operating capacitance μF/km	Current carrying capacity (1) A	Short Circuit Current (conductor) kA
1x25/16KON	20230509	5DK4113	6.4	14.8	19	20.5	123	205	890	375	0.795	0.24	178	3.58
1x35/16KON	20004559	5DK4114	7.5	15.9	22.3	23.8	143	238	1000	525	0.565	0.27	220	5.01
1x50/16KON	20004560	5DK4115	9	17.4	23.8	25.3	152	253	1190	750	0.393	0.3	275	7.15
1x70/16KON	20004561	5DK4116	10.8	19.2	25.9	28.2	169	282	1460	1050	0.277	0.34	340	10.01
1x95/16KON	20004562	5DK4117	12.6	21	27.7	30	180	300	1710	1425	0.21	0.38	409	13.59
1x120/16KON	20004563	5DK4118	14.2	22.6	30.3	32.6	196	326	2070	1800	0.164	0.42	479	17.16
1x150/25KON	20004565	5DK4120	15.8	24.2	32.2	34.4	206	344	2470	2250	0.132	0.46	549	21.45
1x185/25KON	20057165	5DK4121	17.4	25.8	33.8	36	216	360	2810	2775	0.108	0.49	627	26.46
1x240/25KON	20004566	5DK4122	20.4	29.1	38.1	40.3	242	403	3490	3600	0.0817	0.54	734	34.32
1x300/25KON	20154987	5DK4***	22.9	31.6	40.3	42.5	255	425	4150	4500	0.0641	0.59	843	42.9
1x400/25KON	20161468	5DK4***	26.2	33	43	46	276	460	5000	6000	0.05	0.66	1024	57.2

(1) Nominal current carrying capacity for single-core rubber cables laid on a surface, at 30°C ambient temperature. For derating-factors see tables in Technical Appendix

Special designs available upon request, e.g.:

- halogen-free version with 5GM3 outer sheath
- special version for submersible application

PROTOLON NTMCCW0EU 8.7/15 kV

Number of cores x cross section	Part number	MLFB Number	Conductor diameter max. mm	Diameter over insulation (nom.) mm	Outer diameter min. mm	Outer diameter max. mm	Bending radius fixed min. mm	Bending radius free moving min. mm	Weight (approx.) kg/km	Permissible tensile force max. N	Conductor resistance at 20°C max. Ω/km	Nominal operating capacitance μF/km	Current carrying capacity (1) A	Short Circuit Current (conductor) kA
1x25/16KON	20004680	SDK5104	6.4	17	23.4	24.9	149	249	950	375	0.795	0.2	189	3.58
1x35/16KON			7.5	18.1	24.9	27.1	163	271	1110	525	0.565	0.22	234	5.01
1x50/16KON	20160141	5DK5***	9	19.6	26.4	28.6	172	286	1300	750	0.393	0.25	292	7.15
1x70/16KON			10.8	21.4	28.1	30.4	182	304	1550	1050	0.277	0.28	360	10.01
1x95/16KON		5DK5101	12.6	23.2	30.9	33.2	199	332	1880	1425	0.21	0.31	434	13.59
1x120/16KON	20042544	5DK5105	14.2	24.8	32.5	34.8	209	348	2200	1800	0.164	0.34	505	17.16
1x150/25KON	20092201	5DK5097	15.8	26.4	34.4	36.6	220	366	2610	2250	0.132	0.37	582	21.45
1x185/25KON	20067340	5DK5098	17.4	28	37	39.2	235	392	3090	2775	0.108	0.4	664	26.46
1x240/25KON	20004677	5DK5099	20.4	31	40	42.2	253	422	3680	3600	0.0817	0.45	781	34.32
1x300/25KON	20004678	5DK5102	22.9	33.5	42.2	44.4	266	444	4290	4500	0.0654	0.49	898	42.9
1x400/35KON	20025950	5DK5100	26.2	36.8	45.2	48.2	289	482	5290	6000	0.0495	0.55	1074	57.2

PROTOLON NTMCCW0EU 12/20 kV

Number of cores x cross section	Part number	MLFB Number	Conductor diameter max. mm	Diameter over insulation (nom.) mm	Outer diameter min. mm	Outer diameter max. mm	Bending radius fixed min. mm	Bending radius free moving min. mm	Weight (approx.) kg/km	Permissible tensile force max. N	Conductor resistance at 20°C max. Ω/km	Nominal operating capacitance μF/km	Current carrying capacity (1) A	Short Circuit Current (conductor) kA
1x25/16KON	20004710	5DK5562	6.4	19	25.7	28	168	280	1150	375	0.795	0.18	189	3.58
1x35/16KON	20004711	5DK5564	7.5	20.1	26.8	29.1	175	291	1290	525	0.565	0.19	234	5.01
1x50/16KON	20004712	5DK5566	9	21.6	28.3	30.6	184	306	1490	750	0.393	0.22	292	7.15
1x70/16KON	20004713	5DK5568	10.8	23.4	31.1	33.4	200	334	1750	1050	0.277	0.24	360	10.01
1x95/16KON	20004714	5DK5571	12.6	25.2	32.9	35.2	211	352	2110	1425	0.21	0.27	434	13.59
1x120/16KON	20037708	5DK5573	14.2	26.8	34.5	36.8	221	368	2400	1800	0.164	0.29	505	17.16
1x150/25KON	20004715	5DK5575	15.8	28.4	37.4	39.6	238	396	2910	2250	0.132	0.32	582	21.45
1x185/25KON	20004716	5DK5577	17.4	30	39	41.2	247	412	3270	2775	0.108	0.34	664	26.46
1x240/25KON	20004717	5DK5580	20.4	33	42	44.2	265	442	3880	3600	0.0817	0.39	781	34.32
1x300/25KON	20098501	5DK5581	22.9	34.7	44	47	282	470	4540	4500	0.0654	0.43	898	42.9
1x400/35KON	20004718	5DK5582	26.2	39.3	49.4	52.4	314	524	5760	6000	0.0495	0.5	1074	57.2

(1) Nominal current carrying capacity for single-core rubber cables laid on a surface, at 30°C ambient temperature. For derating-factors see tables in Technical Appendix

Special designs available upon request, e.g.:

- halogen-free version with 5GM3 outer sheath
- special version for submersible application

PROTOLON NTMCGW0EU 14/25 kV

Number of cores x cross section	Part number	MLFB Number	Conductor diameter max. mm	Diameter over insulation (nom.) mm	Outer diameter min. mm	Outer diameter max. mm	Bending radius fixed min. mm	Bending radius free moving min. mm	Weight (approx.) kg/km	Permissible tensile force max. N	Conductor resistance at 20°C max. Ω/km	Nominal operating capacitance μF/km	Current carrying capacity (1) A	Short Circuit Current (conductor) kA
1x25/16KON			6.4	21.6	28.3	30.6	184	306	1250	375	0.795	0.16	189	3.58
1x35/16KON	20166631	5DK6***	7.5	22.7	30.4	32.7	196	327	1470	525	0.565	0.17	234	5.01
1x50/16KON			9	24.2	31.9	34.2	205	342	1680	750	0.393	0.19	292	7.15
1x70/16KON			10.8	26	33.7	36	216	360	1950	1050	0.277	0.21	360	10.01
1x95/16KON	20004737	5DK6483	12.6	27.8	38.1	40.4	242	404	2620	1425	0.21	0.23	434	13.59
1x120/16KON	20004737	5DK6483	14.2	29.4	38.1	40.4	242	404	2620	1800	0.164	0.25	505	17.16
1x150/25KON			15.8	31	40.5	42.7	256	427	3050	2250	0.132	0.27	582	21.45
1x185/25KON			17.4	32.6	42.1	44.3	266	443	3420	2775	0.108	0.29	664	26.46
1x240/25KON			20.4	35.6	45.1	47.3	284	473	4070	3600	0.0817	0.33	781	34.32
1x300/25KON	20024422	5DK6484	22.9	38.1	48.1	50.3	302	503	4920	4500	0.0654	0.36	898	42.9

PROTOLON NTMCGW0EU 18/30 kV

Number of cores x cross section	Part number	MLFB Number	Conductor diameter max. mm	Diameter over insulation (nom.) mm	Outer diameter min. mm	Outer diameter max. mm	Bending radius fixed min. mm	Bending radius free moving min. mm	Weight (approx.) kg/km	Permissible tensile force max. N	Conductor resistance at 20°C max. Ω/km	Nominal operating capacitance μF/km	Current carrying capacity (1) A	Short Circuit Current (conductor) kA
1x25/16KON	20163251	5DK68**	6.4	24	32.7	35	210	350	1570	375	0.795	0.14	189	3.58
1x35/16KON			7.5	25.1	32.8	35.1	211	351	1600	525	0.565	0.15	234	5.01
1x50/16KON	20160142	5DK68**	9	26.6	34.4	36.6	220	366	1860	750	0.393	0.17	292	7.15
1x70/16KON	20163749	5DK6871	10.8	28.4	37.1	39.4	236	394	2230	1050	0.277	0.19	360	10.01
1x95/16KON	20004749	5DK6876	12.6	30.2	39.4	41.7	250	417	2470	1425	0.21	0.21	434	13.59
1x120/16KON	20091154	5DK687	14.2	31.8	40.5	42.8	257	428	2840	1800	0.164	0.23	505	17.16
1x150/25KON			15.8	33.4	42.9	45.1	271	451	3280	2250	0.132	0.24	582	21.45
1x185/25KON	20179552	5DK6894	17.4	35	44	46.2	277	462	3750	2775	0.108	0.26	664	26.46
1x240/25KON	20016646	5DK6879	20.4	38	48	50.2	301	502	4550	3600	0.0817	0.29	781	34.32
1x300/25KON			22.9	40.5	50.7	53.7	322	537	5100	4500	0.0654	0.32	898	42.9
1x400/35KON			26.2	43.8	57	60	360	600	6100	6000	0.0495	0.35	1074	57.2

(1) Nominal current carrying capacity for single-core rubber cables laid on a surface, at 30°C ambient temperature. For derating-factors see tables in Technical Appendix

Special designs available upon request, e.g.:

- halogen-free version with 5GM3 outer sheath
- special version for submersible application

PROTOLON(M) (N)TMCGCW0EU 6 kV – 30 kV

MV flexible single-core cable with optimized wall-thickness



Application

In general single-core cables are used in short length e.g. for connection of switchgear cubicles and for connection of mobile transformer substations to the overhead lines. While laying and during operation care should be taken to protect the cables against excessive mechanical stresses. Furthermore the general conditions in DIN VDE 0298-3 have to be applied.

Global data

Brand	PROTOLON(M)
Type designation	(N)TMCGCW0EU
Standard	Based on DIN VDE 0250-813
Certifications / Approvals	Fire Certificate of Russian Federation GOST-R/-K/-B

Design features

Conductor	Finely stranded copper conductor, tinned (class 5), acc. DIN VDE 0295/ IEC 60228
PE-Conductor	Spinning with tinned copper wires, 16mm ² or 25mm ²
Insulation	PROTOLON, Basic material: EPR, Compound type: Special compound better 3GI3
Electrical field control	Inner and outer layer of semiconductive rubber compound, cold strippable outer layer
Outer sheath	Special compound, Basic material: Chlorinated rubber, Compound type: 5GM3, Color: Red

Electrical parameters

Rated voltage	3.6/6 kV	6/10 kV	8.7/15 kV
Max. permissible operating voltage AC	4.2/7.2 kV	6,9/12 kV	10.4/18 kV
Max. permissible operating voltage DC	5.4/10.8 kV	9/18 kV	13.5/27 kV
AC test voltage	11 kV	17 kV	24 kV
	12/20 kV	14/25 kV	18/30 kV
	13.9/24 kV	17.3/30 kV	20.8/36 kV
	18/36 kV	22.5/45 kV	27/54 kV
	29 kV	36 kV	43 kV

Chemical parameters

Performance against fire	IEC 60332-1-2
Resistance to oil	IEC 60811-404
Weather resistance	Unrestricted use outdoors and indoors, resistant to ozone, UV, and moisture

Thermal parameters

Max. operating temperature of the conductor	90 °C
Max. short circuit temperature of the conductor	250 °C
Ambient temperature for fixed installation	min -40 °C ; max +80 °C
Ambient temperature in fully flexible operation	min -25 °C ; max +60 °C

Mechanical parameters

Max. tensile load on the conductor	15 N/mm ²
Torsional stress +/-	25 °/m
Bending radii min.	Acc. to DIN VDE 0298 part 3

PROTOLON(M) (N)TMCGCWOEU 3.6/6 kV

Number of cores x cross section	Part number	MLFB Number	Conductor diameter max. mm	Diameter over insulation (nom.) mm	Outer diameter min. mm	Outer diameter max. mm	Bending radius fixed min. mm	Bending radius free moving min. mm	Weight (approx.) kg/km	Permissible tensile force max. N	Conductor resistance at 20°C max. Ω/km	Nominal operating capacitance μF/km	Current carrying capacity (1) A	Short Circuit Current (conductor) kA
1x25/16KON		5DT0124	6.4	12.2	18.8	20.3	122	203	710	375	0.795	0.33	178	3.58
1x35/16KON	20267593	5DK3***	7.5	13.3	17.9	19.4	116	194	790	525	0.565	0.37	220	5.01
1x50/16KON	20176480	5DK3***	9	14.8	21.2	22.7	136	227	990	750	0.393	0.43	275	7.15
1x70/16KON	20205594	5DK3***	10.8	16.6	23	24.5	147	245	1210	1050	0.277	0.49	340	10.01
1x95/16KON		5DT0128	12.6	18.4	25.1	27.4	164	274	1490	1425	0.21	0.55	409	13.59
1x120/16KON		5DT0129	14.2	20	26.7	29	174	290	1750	1800	0.164	0.61	479	17.16
1x150/25KON		5DT0130	15.8	21.6	29.1	31.3	188	313	2150	2250	0.132	0.66	549	21.45
1x185/25KON	20181101	5DK3***	17.4	23.2	31.7	33.9	203	339	2540	2775	0.108	0.72	627	26.46
1x240/25KON		5DT0132	20.4	26.2	34.7	36.9	221	369	3120	3600	0.0817	0.82	734	34.32
1x300/25KON		5DT0133	22.9	28.7	38.2	40.4	242	404	3780	4500	0.0641	0.91	843	42.9
1x400/35KON	20154644	5DK3***	26.2	32	39.7	42.7	256	427	4400	6000	0.0486	1.03	1024	57.2

PROTOLON(M) (N)TMCGCWOEU 6/10 kV

Number of cores x cross section	Part number	MLFB Number	Conductor diameter max. mm	Diameter over insulation (nom.) mm	Outer diameter min. mm	Outer diameter max. mm	Bending radius fixed min. mm	Bending radius free moving min. mm	Weight (approx.) kg/km	Permissible tensile force max. N	Conductor resistance at 20°C max. Ω/km	Nominal operating capacitance μF/km	Current carrying capacity (1) A	Short Circuit Current (conductor) kA
1x25/16KON		5DT0135	6.4	12.2	19.4	20.9	125	209	720	375	0.795	0.33	178	3.58
1x35/16KON		5DT0136	7.5	13.9	20.5	22	132	220	850	525	0.565	0.34	220	5.01
1x50/16KON		5DT0137	9	15.4	21.8	23.3	140	233	1020	750	0.393	0.39	275	7.15
1x70/16KON		5DT0138	10.8	17.2	23.6	25.1	151	251	1240	1050	0.277	0.44	340	10.01
1x95/16KON		5DT0139	12.6	19	25.7	28	168	280	1520	1425	0.21	0.5	409	13.59
1x120/16KON	20183692	5DK4***	14.2	20.6	25	27.3	164	273	1780	1800	0.164	0.55	479	17.16
1x150/25KON	20167513	5DK4***	15.8	22.2	30.7	32.9	197	329	2250	2250	0.132	0.6	549	21.45
1x185/25KON		5DT0142	17.4	23.79	32.3	34.5	207	345	2580	2775	0.108	0.65	627	26.46
1x240/25KON	20167514	5DK4***	20.4	26.79	37.9	40.1	241	401	3360	3600	0.0817	0.74	734	34.32
1x300/25KON	20258128	5DK4***	22.9	29.29	38.8	41	246	410	3850	4500	0.0641	0.82	843	42.9

(1) Nominal current carrying capacity for single-core rubber cables laid on a surface, at 30°C ambient temperature. For derating-factors see tables in Technical Appendix

PROTOLON(M) (N)TMCGCWOEU 8.7/15 kV

Number of cores x cross section	Part number	MLFB Number	Conductor diameter max. mm	Diameter over insulation (nom.) mm	Outer diameter min. mm	Outer diameter max. mm	Bending radius fixed min. mm	Bending radius free moving min. mm	Weight (approx.) kg/km	Permissible tensile force max. N	Conductor resistance at 20°C max. Ω/km	Nominal operating capacitance μF/km	Current carrying capacity (1) A	Short Circuit Current (conductor) kA
1x25/16KON		5DT0146	6.4	14.4	21	22.5	135	225	800	375	0.795	0.25	189	3.58
1x35/16KON	20113330	5DK5107	7.5	15.5	22	23.5	141	235	940	525	0.565	0.28	234	5.01
1x50/16KON		5DT0148	9	17	23.4	24.9	149	249	1090	750	0.393	0.31	292	7.15
1x70/16KON		5DT0149	10.8	18.8	25.5	27.8	167	278	1360	1050	0.277	0.36	360	10.01
1x95/16KON	20227705	5DK5***	12.6	20.6	26.3	28.6	172	286	1550	1425	0.21	0.4	434	13.59
1x120/16KON		5DT0151	14.2	22.2	28.9	31.2	187	312	1880	1800	0.164	0.44	505	17.16
1x150/25KON	20225873	5DK5***	15.8	23.8	32.3	34.5	207	345	2360	2250	0.132	0.48	582	21.45
1x185/25KON		5DT0153	17.4	25.4	33.9	36.1	217	361	2690	2775	0.108	0.52	664	26.46
1x240/25KON	20007564	5DK5110	20.4	28.1	36.4	38.6	232	386	3330	3600	0.0817	0.61	781	34.32
1x300/25KON		5DT0154	22.9	30.9	40.4	42.6	256	426	3960	4500	0.0641	0.65	898	42.9
1x400/35KON	20025884	5DK5112	26.2	33.9	41.9	44.9	269	449	4980	6000	0.0486	0.76	1074	57.2

PROTOLON(M) (N)TMCGCWOEU 12/20 kV

Number of cores x cross section	Part number	MLFB Number	Conductor diameter max. mm	Diameter over insulation (nom.) mm	Outer diameter min. mm	Outer diameter max. mm	Bending radius fixed min. mm	Bending radius free moving min. mm	Weight (approx.) kg/km	Permissible tensile force max. N	Conductor resistance at 20°C max. Ω/km	Nominal operating capacitance μF/km	Current carrying capacity (1) A	Short Circuit Current (conductor) kA
1x25/16KON		5DT0156	6.4	15.8	22.2	23.7	142	237	860	375	0.795	0.22	189	3.58
1x35/16KON	20008239	5DK5593	7.5	16.3	22.3	23.8	143	238	970	525	0.565	0.26	234	5.01
1x50/16KON		5DT0157	9	18.4	25.1	27.4	164	274	1200	750	0.393	0.27	292	7.15
1x70/16KON		5DT0158	10.8	20.2	26.9	29.2	175	292	1440	1050	0.277	0.31	360	10.01
1x95/16KON	20219047	5DK5***	12.6	22	28.7	31	186	310	1690	1425	0.21	0.35	434	13.59
1x120/16KON	20016475	5DK5597	14.2	23.4	30.7	33	198	330	2020	1800	0.164	0.39	505	17.16
1x150/25KON		5DT0160	15.8	25.2	33.7	35.9	215	359	2450	2250	0.132	0.41	582	21.45
1x185/25KON		5DT0161	17.4	26.8	35.3	37.5	225	375	2790	2775	0.108	0.44	664	26.46
1x240/25KON	20067202	5DK5599	20.4	29.9	38.4	40.6	244	406	3460	3600	0.0817	0.5	781	34.32
1x300/25KON		5DT0162	22.9	32.3	41.8	44	264	440	4080	4500	0.0641	0.55	898	42.9

(1) Nominal current carrying capacity for single-core rubber cables laid on a surface, at 30°C ambient temperature. For derating-factors see tables in Technical Appendix

PROTOLON(M) (N)TMCGCWOEU 14/25 kV

Number of cores x cross section	MLFB Number	Conductor diameter max. mm	Diameter over insulation (nom.) mm	Outer diameter min. mm	Outer diameter max. mm	Bending radius fixed min. mm	Bending radius free moving min. mm	Weight (approx.) kg/km	Permissible tensile force max. N	Conductor resistance at 20°C max. Ω/km	Nominal operating capacitance μF/km	Current carrying capacity (1) A	Short Circuit Current (conductor) kA
1x25/16KON	5DT0164	6.4	17.6	24.3	26.6	160	266	980	375	0.795	0.19	189	3.58
1x35/16KON	5DT0165	7.5	18.7	25.4	27.7	166	277	1110	525	0.565	0.21	234	5.01
1x50/16KON	5DT0166	9	20.2	26.9	29.2	175	292	1290	750	0.393	0.24	292	7.15
1x70/16KON	5DT0167	10.8	22	28.7	31	186	310	1540	1050	0.277	0.27	360	10.01
1x95/16KON	5DT0168	12.6	23.8	31.5	33.8	203	338	1870	1425	0.21	0.3	434	13.59
1x120/16KON	5DT0169	14.2	25.4	33.1	35.4	212	354	2150	1800	0.164	0.33	505	17.16
1x150/25KON	5DT0170	15.8	27	36.5	38.7	232	387	2660	2250	0.132	0.35	582	21.45
1x185/25KON	5DT0171	17.4	28.6	38.1	40.3	242	403	3013	2775	0.108	0.38	664	26.46
1x240/25KON	5DT0172	20.4	31.6	41.1	43.3	260	433	3620	3600	0.0817	0.43	781	34.32
1x300/25KON	5DT0173	22.9	34.1	43.6	45.8	275	458	4230	4500	0.0641	0.47	898	42.9

PROTOLON(M) (N)TMCGCWOEU 18/30 kV

Number of cores x cross section	Part number	MLFB Number	Conductor diameter max. mm	Diameter over insulation (nom.) mm	Outer diameter min. mm	Outer diameter max. mm	Bending radius fixed min. mm	Bending radius free moving min. mm	Weight (approx.) kg/km	Permissible tensile force max. N	Conductor resistance at 20°C max. Ω/km	Nominal operating capacitance μF/km	Current carrying capacity (1) A	Short Circuit Current (conductor) kA
1x25/16KON	20170616	5DK6***	6.4	19.2	23.6	25.9	155	259	1070	375	0.795	0.18	189	3.58
1x35/16KON		5DT0176	7.5	20.3	27	29.3	176	293	1200	525	0.565	0.19	234	5.01
1x50/16KON	20180066	5DK6***	9	23.6	28.5	30.8	185	308	1390	750	0.393	0.21	292	7.15
1x70/16KON	20168804	5DK6***	10.8	21.8	30.3	32.6	196	326	1640	1050	0.277	0.24	360	10.01
1x95/16KON	20160148	5DK6***	12.6	25.4	32.1	34.4	206	344	1910	1425	0.21	0.27	434	13.59
1x120/16KON	20181538	5DK6895	14.2	27	34.7	37	222	370	2300	1800	0.164	0.29	505	17.16
1x150/25KON	20175508	5DK6***	15.8	28.6	36.5	38.7	232	387	2660	2250	0.132	0.31	582	21.45
1x185/25KON	20222816	5DK6***	17.4	30.2	39.8	42	252	420	3100	2775	0.108	0.34	664	26.46
1x240/25KON	20007565	5DK6867	20.4	32.9	41.2	43.4	260	434	3730	3600	0.0817	0.39	781	34.32
1x300/25KON	20171274	5DK6***	22.9	35.7	45.2	47.4	284	474	4380	4500	0.0641	0.42	898	42.9

(1) Nominal current carrying capacity for single-core rubber cables laid on a surface, at 30°C ambient temperature. For derating-factors see tables in Technical Appendix

OPTOFLEX(M) E9/125

Rubber sheathed flexible fiber-optic cables



Application

For optical signal and data transmission in open-cast mining applications, for use on material handling equipment and for laying alongside conveyor belts (including shiftable conveyor belts).

Global data

Brand	OPTOFLEX(M)
Type designation	E9/125 μ
Standard	Based on FDDI Based on DIN VDE 0888 ISO/IEC 9314-3

Design features

Core identification	Color coding of the fibers and buffering tube for identification of the fiber type
Optical fiber	Transmission data: Monomode fiber: E9/125 Attenuation at wavelength 850 nm: - Attenuation at wavelength 1310 nm: 0.4 dB/km Attenuation at wavelength 1550 nm: 0.3 dB/km Numerical aperture: 0.14 +/- 0.02 Dispersion value at 1300 nm: <3.5 ps/nm km Dispersion value at 1550 nm: <18 ps/nm km Fibre core diameter: 9 μ m; Diameter across the cladding: 125 μ m; Diameter over the coating: 250 μ m;
Fiber covering	Loose tube with filling compound, Basic material: ETFE, Compound: 7YI 1, Natural color
Core arrangement	Six buffering tubes, one layer, especially laid-up around a GRP supporting element (GRP= Glass-fiber reinforced plastic)
Torsion protection	Special braid of Kevlar threads, tensile-strength reinforcement by means of longitudinal Kevlar threads, Surface covered: approx. 80%
Outer sheath	Basic material: synthetic elastomer compound e.g. CR, Compound type: 5GM5, Color: Orange

Chemical parameters

Resistance to oil	IEC 60811-404
Weather resistance	Unrestricted use outdoors and indoors, resistant to ozone, UV and moisture
Water resistance	EN 50525-2-21

Thermal parameters

Max. operating temperature of the conductor	90 °C
Ambient temperature for fixed installation	min -40 °C ; max +80 °C

Mechanical parameters

Torsional stress +/-	100 °/m
Bending radii min.	50 mm (fixed installation)
Additional tests	Tensile load test, transverse pressure test, reversed bending test, roller bending test, torsional stress test

OPTOFLEX(M) E9/125

Number of cores x cross section	Part number	MLFB Number	Outer diameter min. mm	Outer diameter max. mm	Weight (approx.) kg/km
6E9/125 μ	20003606	5DG8 031	9.7	10.1	100
12E9/125 μ	20003607	5DG8 032	9.7	10.1	100
18E9/125 μ	20160113	5DG8 033	9.7	10.1	100
24E9/125 μ	20024482	5DG8 034	9.7	10.1	100

OPTOFLEX(M) G50/125

Rubber sheathed flexible fiber-optic cables



Application

For optical signal and data transmission in open-cast mining applications, for use on material handling equipment and for laying alongside conveyor belts (including shiftable conveyor belts).

Global data

Brand	OPTOFLEX(M)
Type designation	G50/125 μ
Standard	Based on FDDI ISO/IEC 9314-3 Based on DIN VDE 0888

Design features

Core identification	Color coding of the fibers and buffering tube for identification of the fiber type
Optical fiber	Fibre core diameter: 50 μ m; Diameter across the cladding: 125 μ m; Diameter over the coating: 250 μ m; Transmission data: Graded-index: 50/125 Attenuation at wavelength 850 nm: 2.8 dB/km Attenuation at wavelength 1310 nm: 0.8dB/km Attenuation at wavelength 1550 nm: - Bandwidth at 850 nm: \geq 400 MHz Bandwidth at 1300 nm: $>$ 1200 MHz Numerical aperture: 0.200 +/- 0.02
Fiber covering	Loose tube with filling compound, Basic material: ETFE, Compound: 7YI 1, Natural color
Core arrangement	Six buffering tubes, one layer, especially laid-up around a GRP supporting element (GRP= Glass-fiber reinforced plastic)
Torsion protection	Special braid of Kevlar threads, tensile-strength reinforcement by means of longitudinal Kevlar threads, Surface covered: approx. 80%
Outer sheath	Basic material: synthetic elastomer compound e.g. CR, Compound type: 5GM5, Color: Orange

Chemical parameters

Resistance to oil	IEC 60811-404
Weather resistance	Unrestricted use outdoors and indoors, resistant to ozone, UV and moisture
Water resistance	EN 50525-2-21

Thermal parameters

Max. operating temperature of the conductor	90 °C
Ambient temperature for fixed installation	min -40 °C ; max +80 °C

Mechanical parameters

Torsional stress +/-	100 °/m
Bending radii min.	50 mm (fixed installation)
Additional tests	Tensile load test, transverse pressure test, reversed bending test, roller bending test, torsional stress test

OPTOFLEX(M) G50/125

Number of cores x cross section	Part number	MLFB Number	Outer diameter min. mm	Outer diameter max. mm	Weight (approx.) kg/km
6G50/125 μ	20003604	5DG8 028	9.7	10.1	100
12G50/125 μ	20003605	5DG8 030	9.7	10.1	100
18G50/125 μ	20008465	5DG8 027	9.7	10.1	100
24G50/125 μ	20101418	5DG8 026	9.7	10.1	100

OPTOFLEX(M) G62,5/125

Rubber sheathed flexible fiber-optic cables



Application

For optical signal and data transmission in open-cast mining applications, for use on material handling equipment and for laying alongside conveyor belts (including shiftable conveyor belts).

Global data

Brand	OPTOFLEX(M)
Type designation	G62,5/125 μ
Standard	Based on FDDI Based on DIN VDE 0888 ISO/IEC 9314-3

Design features

Core identification	Color coding of the fibers and buffering tube for identification of the fiber type
Optical fiber	Transmission data: Graded-index: 62.5/125 Attenuation at wavelength 850 nm: 3.3 dB/km Attenuation at wavelength 1310 nm: 0.9 dB/km Attenuation at wavelength 1550 nm: - Bandwidth at 850 nm: ≥ 400 MHz Bandwidth at 1300 nm: > 600 MHz Numerical aperture: 0.275 +/- 0.02 Fibre core diameter: 62.5 μm ; Diameter across the cladding: 125 μm ; Diameter over the coating: 250 μm ;
Fiber covering	Loose tube with filling compound, Basic material: ETFE, Compound: 7YI 1, Natural color
Core arrangement	Six buffering tubes, one layer, especially laid-up around a GRP supporting element (GRP= Glass-fiber reinforced plastic)
Torsion protection	Special braid of Kevlar threads, tensile-strength reinforcement by means of longitudinal Kevlar threads, Surface covered: approx. 80%
Outer sheath	Basic material: synthetic elastomer compound e.g. CR, Compound type: 5GM5, Color: Orange

Chemical parameters

Resistance to oil	IEC 60811-404
Weather resistance	Unrestricted use outdoors and indoors, resistant to ozone, UV and moisture
Water resistance	EN 50525-2-21

Thermal parameters

Max. operating temperature of the conductor	90 °C
Ambient temperature for fixed installation	min -40 °C ; max +80 °C

Mechanical parameters

Torsional stress +/-	100 °/m
Bending radii min.	50 mm (fixed installation)
Additional tests	Tensile load test, transverse pressure test, reversed bending test, roller bending test, torsional stress test

OPTOFLEX(M) G62.5/125

Number of cores x cross section	Part number	MLFB Number	Outer diameter min. mm	Outer diameter max. mm	Weight (approx.) kg/km
6G62,5/125 μ	20003601	5DG8 021	9.7	10.1	100
12G62,5/125 μ	20003602	5DG8 022	9.7	10.1	100
18G62,5/125 μ	20160111	5DG8 038	9.7	10.1	100
24G62,5/125 μ	20160112	5DG8 ...	9.7	10.1	100

PROTOMONT(MSR) 2YSLGCGOEU 250V

Data, signal and control cables for mining installations



Application

Control, signalling and bus cables with the necessary transmission characteristics used for electric and electronic equipment, such as for measured value and process data processing and automation units in open-cast mining applications. Suitable for laying alongside conveyor belts and on material handling equipment for open-cast and underground mining.

Global data

Brand	PROTOMONT MSR-Mining
Type designation	2YSLGCGOEU
Standard	Based on DIN VDE 0250-1
Certifications / Approvals	EAC-Certificate

Design features

Conductor	Finely-stranded bare copper conductor class 5 (acc. to IEC 60028)
Insulation	Basic material: Polyethylene (PE), Compound type: 2YI1
Core identification	Cores white with black digits imprinted
Core arrangement	Cores are laid-up in pairs in layers with a continuous serving of non-hygroscopic material over the conductor assembly
Inner sheath	Basic material (special compound type): Chlorinated rubber, Compound type: EM2
Screen over inner sheath	Screen braiding of tinned copper wires between inner and outer sheath
Outer sheath	Basic material (Special compound type): Chlorinated rubber, Compound type: EM2

Electrical parameters

Rated voltage	250/250 V
Max. permissible operating voltage AC	0.350 (peak value) kV
Max. permissible operating voltage DC	0.350 (peak value) kV
AC test voltage	1.5 kV

Chemical parameters

Performance against fire	IEC 60332-1-2
Resistance to oil	IEC 60811-404
Weather resistance	Unrestricted use outdoors and indoors, resistant to ozone and moisture

Thermal parameters

Max. operating temperature of the conductor	60 °C
Max. short circuit temperature of the conductor	150 °C
Ambient temperature for fixed installation	min -40 °C ; max +60 °C
Ambient temperature in fully flexible operation	min -25 °C ; max +60 °C

Mechanical parameters

Max. tensile load on the conductor	15 N/mm ²
Torsional stress +/-	25 %/m
Bending radii min.	Acc. to DIN VDE 0298 part 3

 PROTOMONT(MSR) 2YSLGCGOEU 250V

Number of cores x cross section	Part number	MLFB Number	Conductor diameter max. mm	Outer diameter min. mm	Outer diameter max. mm	Weight (approx.) kg/km	Permissible tensile force max. N	Conductor resistance at 20°C max. Ω/km	Nominal operating capacitance μF/km	Current carrying capacity (1) A
2x2x1	20005126	5DM4995	1.24	11	13	240	60	19.5	0.65	12
5x2x1	20005127	5DM4996	1.24	16.5	18.1	450	150	19.5	0.65	9
10x2x1	20005128	5DM4997	1.24	20.5	22.2	630	300	19.5	0.65	7
20x2x1	20005129	5DM4998	1.24	25.1	28.1	960	600	19.5	0.65	5



Underground

Index

Product overview	96
SHEARER CABLES FOR CHAIN APPLICATION	98
PROTOMONT(V) NSSHCGE0EU 1 kV	98
PROTOMONT(V) NSSHCGE0EU 1 kV	100
PROTOMONT(V) NTSKCGECW0EU 3 kV – 6 kV	102
PROTOMONT(V0) (N)TSKCGEW0EU 3 kV	104
TENAX-CTE NSSHKCGE0EU 1 kV	106
SHEARER CABLES FOR FREE TRAILING	108
PROTOMONT(Z) NSSHKCGE0EU 1 kV	108
UNDERGROUND REELING CABLES	110
TENAX-LK NTSKCGEW0EU 1 kV	110
PROTOMONT(S) (N)SSHCGE0EU 1 kV	112
CORDAFLEX(S) NSHT0EU 1kV	114
PROTOMONT(M+) (N)SH0EU-J 1 kV	116
CABLES FOR SEMI-FIXED INSTALLATION	118
PROTOMONT NTSKCGECW0EU – Festoon 6 kV	118
SUPROMONT (N)3GHSSYCY 6 kV – 30 kV	120
SUPROMONT (N)3GHSSHCH 6 kV – 20 kV	124
PROTOMONT(MT) (N)SH0EU 1 kV	128
PROTOMONT NSSH0EU .../3E 1 kV	132
PROTOMONT EMV-FC (N)SSHC0EU 1 kV	134

Product overview

SHEARER CABLES FOR CHAIN APPLICATION			
	PROTOMONT(V)	PROTOMONT(V0)	TENAX-CTE
Voltage range (kV)	0.6/1 to 3.6/6	1.8/3 (3.3)	0.6/1 (1.2)
Cable design	Double screen tech.; semicond. core screen (cold removable)	Single screen tech.; semicond. core screen (cold removable)	Single screen tech.; semicond. inner sheath
Permissible tensile force (N/mm ²)	15	15	15
Stability against torsion (°/m)	+/- 25	+/- 50	+/- 50
Sheath quality	5GM5	5GM3	5GM5
Reversed bending stability	+++	+++	+++
Minimum bending radii	at max. 5 N/mm ²	2.3 x D	2.3 x D
	at max. 15 N/mm ²	5 x D	5 x D
Fully flexible temperature range (°C)	-20 to +60	-20 to +60	-20 to +60
Approvals	MA - China, MSHA P-07-KA140034-MSHA, EAC certificate, Fire certificate, Gost -R/-K/-B BAS-Certificat (only for 0.6/1 kV) WUG-Poland (only for 3.6/6 kV)	MA - China, Gost -R/-K/-B	EAC certificate



SHEARER CABLES FOR FREE TRAILING		
	PROTOMONT(Z)	
Voltage range (kV)	0.6/1 to 3.6/6	
Cable design	Double screen tech.; semicond. core screen (cold removable)	
Permissible tensile force (N/mm ²)	40	
Stability against torsion (°/m)	+/- 10	
Sheath quality	5GM5	
Reversed bending stability	+++	
Minimum bending radii	at max. 5 N/mm ²	2.3 x D
	at max. 15 N/mm ²	5 x D
Fully flexible temperature range (°C)	-20 to +60	
Approvals	MA - China, MSHA P-07-KA140034-MSHA, BAS-certificate, EAC certificate	



UNDERGROUND REELING CABLES

	TENAX-LK	PROTOMONT(S)	CORDAFLEX(S)	PROTOMONT(M+)
Special design features	Steel + copper pilot/earth core element; semi-cond. inner sheath	Double concentric copper pilot/earth core element; semi-cond. core screen	No semi-conductive layer	No semi-conductive layer
Travel speed max. (m/min)	160	160	160	60
Permissible tensile force (N/mm ²)	30	30	30	15
Stability against torsion (°/m)	+/- 100	+/- 50	+/- 25	+/- 25
Sheath quality	5GM5	5GM5	5GM5	5GM5
Sheath abrasion	+++	+++	+++	++
Reversed bending stability	+++	+++	+++	++
S-bendings in operation	Multiple planes	Multiple planes	Multiple planes	Single plane
Fully flexible temperature range (°C)	-25 to +60	-25 to +60	-25 to +60	-25 to +60
Approvals	EAC certificate	MA - China, EAC certificate	MSHA P-189-3, EAC certificate	

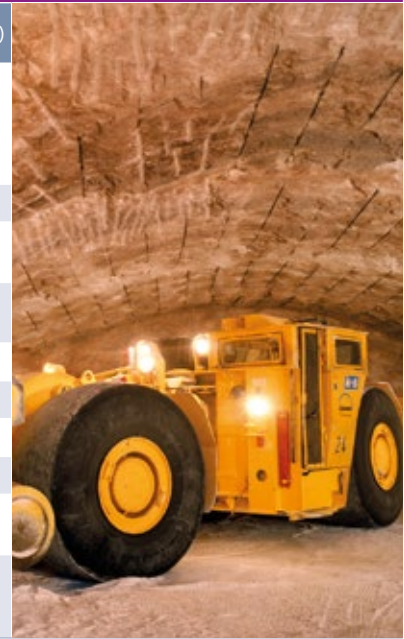

CABLES FOR SEMI-FIXED INSTALLATION

	PROTOMONT Festoon	SUPROMONT (N)3GHSSYCY	SUPROMONT (N)3GHSSHCH
Application	MV semi-fixed	MV semi-fixed	MV semi-fixed
Cable design	Acc. to VDE	Based on VDE	Based on VDE
Special design features	Double screen technology	Double screen technology	Double screen technology Halogen-free
Permissible tensile force (N/mm ²)	15	15	15
Sheath quality	5GM5	PVC YM5	HM4
Reversed bending stability	+++	++	++
Temperature range in fully flexible operation (°C)	-25 to +60	+5 to +60	+5 to +60
Approvals	MA - China, WUG - Poland, BAS-Certificate, Fire certificate, Gost -R/-B/-K	VDE certificate of conformity	VDE certificate of conformity



	PROTOMONT(MT) (N)SHOEU	PROTOMONT NSSHOEU../3E	PROTOMONT EMV-FC
Application	LV semi-fixed	LV semi-fixed	LV frequency converter cable
Cable design	Based on VDE	Acc. to VDE	Acc. to VDE
Special design features		Concentric core screens	Excellent EMC properties
Permissible tensile force (N/mm ²)	15	15	15
Stability against torsion (°/m)		+/- 25	+/- 25
Sheath quality	5GM5	5GM5	5GM5
Reversed bending stability	++	+++	++
Temperature range in fully flexible operation (°C)	-25 to +60	-25 to +60	-25 to +60 -45 to +60
Approvals	VDE certificate with factory surveillance	MA-China, MSHA P-189-3, BAS-certificate, EAC certificate	MSHA P-189-3, EAC certificate

PROTOMONT(V) NSSHCGEOEU 1 kV

Coal cutter cables for chain operation with concentric earth conductor between inner and outer sheath



Application

Used as power supply connection cable for mobile equipment and machines in underground mining applications, such as coal cutting machines, etc. (V)-Coal-Cutter cables are designed for use in cable protection chains (cable handler), which are trailed behind the machine and which absorb the thereby occurring tensile forces.

Global data

Brand	PROTOMONT(V)
Type designation	NSSHCGEOEU
Standard	DIN VDE 0250-812
Certifications / Approvals	MA - China MSHA P-07-KA140034-MSHA BAS - Bosnia-Herzegovina EAC Certificate

Design features

Conductor	Finely stranded copper conductor, tinned (class FS)
PE-Conductor	Concentric earth conductor made of steel-copper strands, helically applied between inner and outer sheath
Insulation	PROTOLON, Basic material: EPR, Compound type: 3GI3
Electrical field control	Cold strippable outer layer of semiconductive rubber compound
Core identification	Main cores: Colored, Black, Grey, Brown; Control cores: Blue
Core arrangement	Three main cores laid-up, with double concentric control/monitoring conductor elements in the outer interstice
Inner sheath	Vulcanized rubber inner sheath, Basic material: EPR, Compound type: GM1B
Outer sheath	PROTOFIRM, Basic material: Synthetic elastomer compound e.g. CM, Compound type: 5GM5 Color: Yellow

Electrical parameters

Rated voltage	0.6/1 kV (600/1000V)
Max. permissible operating voltage AC	0.7/1.2 kV
Max. permissible operating voltage DC	0.9/1.8 kV
AC test voltage - main cores	3 kV (5 Min.)
AC test voltage - control cores	2 kV

Chemical parameters

Performance against fire	IEC 60332-1-2
Resistance to oil	IEC 60811-404
Weather resistance	Unrestricted use outdoors and indoors, resistant to ozone and moisture

Thermal parameters

Max. operating temperature of the conductor	90 °C
Max. short circuit temperature of the conductor	250 °C
Ambient temperature for fixed installation	min -40 °C ; max +80 °C
Ambient temperature in fully flexible operation	min -20 °C ; max +60 °C

Mechanical parameters

Bending radii min.	2.3 x D at a tensile load of max. 5 N/mm ² Acc. to DIN VDE 0298 part 3
Min. distance with S-type directional changes	20 x D

PROTOMONT(V) NSSHCGE0EU 0.6/1 kV

Number of cores x cross section	Part number	MLFB Number	Conductor diameter max. mm	Outer diameter min. mm	Outer diameter max. mm	Weight (approx.) kg/km	Permissible tensile force max. N	Conductor resistance at 20°C max. Ω/km	Nominal operating capacitance μF/km	Inductance nom. mH/km	Current carrying capacity (1) A	Short Circuit Current (conductor) kA
0.6/1 kV NSSHCGE0EU. three-core design												
3x25/16KON +3x(1,5STKON/1,5UELKON)	20024746	5DM1055	7.1	36.9	39.9	2760	1125	0.795	0.6	0.25	131	3.58
3x35/16KON +3x(1,5STKON/1,5UELKON)	20005034	5DM1056	8.4	36.9	39.9	2960	1575	0.565	0.69	0.24	162	5.01
3x50/35KON +3x(1,5STKON/1,5UELKON)	20005035	5DM1057	10.1	42.7	45.7	3920	2250	0.393	0.72	0.24	202	7.15
3x70/35KON +3x(1,5STKON/1,5UELKON)	20005036	5DM1058	11.9	47.7	50.7	5000	3150	0.277	0.84	0.23	250	10.01
3x95/50KON +3x(1,5STKON/1,5UELKON)	20005038	5DM1060	14	56	60	6690	4275	0.21	0.86	0.23	301	13.59
3x120/70KON +3x(1,5STKON/1,5UELKON)	20005049	5DM1090	15.5	58.3	62.3	7690	5400	0.164	0.9	0.22	352	17.16
3x150/70KON +3x(1,5STKON/1,5UELKON)	20007853	5DM1091	17.2	65.9	69.9	9570	6750	0.132	0.93	0.22	404	21.45
0.6/1 kV (N)SSHCGE0EU. six-core design												
(3+3)x50/35KON + 3x(2x1,5STKON)/3x1,5UELKON			10.1	63.3	67.3	8140	4500	0.393			137	7.15
(3+3)x70/70KON +3x(2x1,5STKON)/3x1,5UELKON	20005030	5DM1039	11.9	65.4	69.4	9470	6300	0.277	0.53	0.4	170	10.01
(3+3)x95/70KON +3x(2x1,5STKON)/3x1,5UELKON	20005026	5DM1031	14	71.9	73.9	11270	8550	0.21	0.54	0.37	205	13.59
(3+3)x120/70KON +3x(2x1,5STKON)/3x1,5UELKON			15.8	76.7	80.7	15030	10800	0.164	0.59	0.35	239	17.16

(1) Nominal current carrying capacity for rubber cables laid on a surface, at 30°C ambient temperature (see also VDE 0298-4, Table 15). For derating-factors see tables in Technical Appendix

PROTOMONT(V) NSSHCGEOEU 1 kV

Coal cutter cables for chain operation, with concentric earth conductor over control cores



Application

Used as power supply connection cable for mobile equipment and machines in underground mining applications, such as coal cutting machines, etc. (V)-Coal-Cutter cables are designed for use in cable protection chains (cable handler), which are trailed behind the machine and which absorb the thereby occurring tensile forces.

Global data

Brand	PROTOMONT(V)
Type designation	NSSHCGEOEU
Standard	DIN VDE 0250-812
Certifications / Approvals	MA - China MSHA P-07-KA140034-MSHA BAS - Bosnia-Herzegovina EAC-Certificate

Design features

Conductor	Finely stranded copper conductor, tinned (class FS)
PE-Conductor	Double concentric control/PE wire spinning in outer interstices
Insulation	PROTOLON, Basic material: EPR, Compound type: 3GI3
Electrical field control	Cold strippable outer layer of semiconductive rubber compound
Core identification	Main cores: Colored, Black, Grey, Brown; Control cores: Blue
Core arrangement	Three main cores laid-up, with double concentric control/PE conductor elements in the outer interstice
Inner sheath	Vulcanized rubber inner sheath, Basic material: EPR, Compound type: GM1B
Monitoring conductor	Closed lay spinning of steel/copper wires in a vulcanized bond between inner and outer sheath - monitoring conductor
Outer sheath	PROTOFIRM, Basic material: Synthetic elastomer compound e.g. CM, Compound type: 5GM5, Color: Yellow

Electrical parameters

Rated voltage	0.6/1 kV (600/1000V)
Max. permissible operating voltage AC	0.7/1.2 kV
Max. permissible operating voltage DC	0.9/1.8 kV
AC test voltage	3 kV
AC test voltage - control cores	2 kV

Chemical parameters

Performance against fire	IEC 60332-1-2
Resistance to oil	IEC 60811-404
Weather resistance	Unrestricted use outdoors and indoors, resistant to ozone and moisture

Thermal parameters

Max. operating temperature of the conductor	90 °C
Max. short circuit temperature of the conductor	250 °C
Ambient temperature for fixed installation	min -40 °C ; max +80 °C
Ambient temperature in fully flexible operation	min -20 °C ; max +60 °C

Mechanical parameters

Max. tensile load on the conductor	15 N/mm ²
Bending radii min.	2.3 x D at a tensile load of max. 5 N/mm ² Acc. to DIN VDE 0298 part 3
Min. distance with S-type directional changes	20 x D

PROTOMONT(V) NSSHCGEUEU 0.6/1 kV

Number of cores x cross section	Part number	MLFB Number	Conductor diameter max. mm	Outer diameter min. mm	Outer diameter max. mm	Weight (approx.) kg/km	Permissible tensile force max. N	Conductor resistance at 20°C max. Ω/km	Nominal operating capacitance μF/km	Inductance nom. mH/km	Current carrying capacity (1) A	Short Circuit Current (conductor) kA
0.6/1 kV NSSHCGEUEU, three-core design												
3x25+3x(1,5STKON + 16/3KON)+UELKON	20171091	5DM1***	7.1	38.4	41.4	2900	1125	0.795	0.35	0.33	131	3.58
3x35+3x(1,5STKON + 16/3KON)+UELKON	20174776	5DM1156	8.4	41	44	3520	1575	0.565	0.4	0.3	162	5.01
3x50+3x(1,5STKON + 25/3KON)+UELKON	20181151	5DM1***	10.1	45.4	48.4	4300	2250	0.393	0.46	0.28	202	7.15
3x70+3x(1,5STKON + 35/3KON)+UELKON	20180359	5DM1***	11.9	48.8	52.8	5400	3150	0.277	0.53	0.27	250	10.01
3x95+3x(1,5STKON + 50/3KON)+UELKON	20180360	5DM1159	14	56	60	7020	4275	0.21	0.54	0.27	301	13.59
3x120+3x(1,5STKON + 70/3KON)+UELKON	20181191	5DM1***	15.5	60.3	64.3	8600	5400	0.164	0.58	0.26	352	17.16
3x150+3x(1,5STKON + 70/3KON)+UELKON	20168984	5DM1616	17.2	66.7	70.7	10310	6750	0.132	0.64	0.26	404	21.45
3x185+3x(1,5STKON + 95/3KON)+UELKON	20181193	5DM1***	19.1	71.7	75.7	12300	8325	0.108	0.7	0.26	461	26.46
3x240+3x(1,5STKON + 120/3KON)+UELKON	20181194	5DM1***	22	80.1	85.1	15400	10800	0.0817	0.79	0.25	540	34.32

(1) Nominal current carrying capacity for rubber cables laid on a surface, at 30°C ambient temperature (see also VDE 0298-4, Table 15). For derating-factors see tables in Technical Appendix

PROTOMONT(V) NTSKCGECWOEU 3 kV – 6 kV

Coal cutter cable for chain operation



Application

Used as power supply connection cable for mobile equipment and machines in underground mining applications, such as coal cutting machines, etc. (V) Coal-Cutter-Cables are designed for use in cable protection chains (cable handler), which are trailed behind the machine and which absorb the thereby occurring tensile forces.

Global data

Brand	PROTOMONT(V)
Type designation	NTSKCGECWOEU
Standard	DIN VDE 0250-813
Certifications / Approvals	MA – China MSHA P-07-KA140034-MSHA Fire Certificate of Russian Federation GOST-R/-K/-B

Design features

Conductor	Finely stranded copper conductor, tinned (class FS)
PE-Conductor	Double concentric control/PE wire spinning in outer interstices
Insulation	PROTOLON, Basic material EPR, compound type: 3GI3
Electrical field control	Cold strippable outer layer of semiconductive rubber compound
Core identification	Main cores: Natural color Control cores: Blue
Core arrangement	Three main cores laid-up, with double concentric control/PE conductor elements in the outer interstice
Inner sheath	Vulcanized rubber inner sheath, Basic material: EPR, Compound type: GM1B
Armouring	Closed-lay spinning of steel/copper wires between inner and outer sheath
Outer sheath	PROTOFIRM, Basic material: synthetic elastomer compound e.g. CM, Compound type: 5GM5, Color: Red

Electrical parameters

Rated voltage	1.8/3 kV	3.6/6 kV
Max. permissible operating voltage AC	2.1/3.6 kV	4.2/7.2 kV
Max. permissible operating voltage DC	2.7/5.4 kV	5.4/10.8 kV
AC test voltage	6 kV	11 kV
AC test voltage - control cores	2 kV	2 kV

Chemical parameters

Performance against fire	IEC 60322-1-2
Resistance to oil	IEC 60811-404
Weather resistance	Unrestricted use outdoors and indoors, resistant to ozone and moisture

Thermal parameters

Max. operating temperature of the conductor	90 °C
Max. short circuit temperature of the conductor	250 °C
Ambient temperature for fixed installation	min -40 °C ; max +80 °C
Ambient temperature in fully flexible operation	min -20 °C ; max +60 °C

Mechanical parameters

Max. tensile load on the conductor	15 N/mm ²
Bending radii min.	Acc. to DIN VDE 0298 part 3 2.3 x D at a tensile load of max. 5 N/mm ²
Min. distance with S-type directional changes	20 x D

PROTOMONT(V) NTSKCGECW0EU 1.8/3 kV

Number of cores x cross section	Part number	MLFB Number	Conductor diameter max. mm	Outer diameter min. mm	Outer diameter max. mm	Weight (approx.) kg/km	Permissible tensile force max. N	Conductor resistance at 20°C max. Ω/km	Nominal operating capacitance μF/km	Inductance nom. mH/km	Current carrying capacity (1) A	Short Circuit Current (conductor) kA
1.8/3 kV NTSKCGECW0EU three-core design												
3x25+3x(1,5STKON + 16/3KON)+UELKON			7.1	40.1	43.1	3100	1125	0.795	0.33	0.32	131	3.58
3x35+3x(1,5STKON + 25/3KON)+UELKON	20016353	5DM1556	8.4	44.3	47.3	3970	1575	0.565	0.38	0.3	162	5.01
3x50+3x(1,5STKON + 25/3KON)+UELKON	20024209	5DM1550	10.1	49.7	52.7	4900	2250	0.393	0.44	0.29	202	7.15
3x70+3x(1,5STKON + 35/3KON)+UELKON	20005071	5DM1557	11.9	53.2	57.2	6020	3150	0.277	0.5	0.27	250	10.01
3x95+3x(1,5STKON + 50/3KON)+UELKON	20005051	5DM1108	14	58.6	62.6	7450	4275	0.21	0.54	0.27	301	13.59
3x120+3x(1,5STKON + 70/3KON)+UELKON	20005072	5DM1558	15.5	62.9	66.9	9060	5400	0.164	0.58	0.27	352	17.16
3x150+3x(1,5STKON + 70/3KON)+UELKON	20007583	5DM1559	17.2	69	73	10820	6750	0.132	0.64	0.26	404	21.45
3x185+3x(1,5STKON + 95/3KON)+UELKON	20007584	5DM1584	19.1	73.2	77.2	12530	8325	0.108	0.7	0.25	461	26.46
3x240+3x(1,5STKON + 120/3KON)+UELKON	20008325	5DM1586	22	80.7	85.7	15700	10800	0.0817	0.79	0.25	540	34.32

PROTOMONT(V) NTSKCGECW0EU 3.6/6 kV

Number of cores x cross section	Part number	MLFB Number	Conductor diameter max. mm	Outer diameter min. mm	Outer diameter max. mm	Weight (approx.) kg/km	Permissible tensile force max. N	Conductor resistance at 20°C max. Ω/km	Nominal operating capacitance μF/km	Inductance nom. mH/km	Current carrying capacity (1) A	Short Circuit Current (conductor) kA
3.6/6 kV NTSKCGECW0EU three control cores												
3x25+3x(1,5STKON + 16/3KON)+UELKON			7.1	45	48	3600	1125	0.795	0.34	0.33	131	3.58
3x35+3x(1,5STKON + 25/3KON)+UELKON	20005070	5DM1548	8.4	48.3	51.3	4360	1575	0.565	0.38	0.31	162	5.01
3x50+3x(1,5STKON + 25/3KON)+UELKON	20048331	5DM1549	10.1	51.4	55.4	5320	2250	0.393	0.43	0.3	202	7.15
3x70+3x(1,5STKON + 35/3KON)+UELKON	20005068	5DM1541	11.9	56.7	60.7	6560	3150	0.277	0.49	0.29	250	10.01
3x95+3x(1,5STKON + 50/3KON)+UELKON	20005069	5DM1542	14	61.2	65.2	7890	4275	0.21	0.55	0.28	301	13.59
3x120+3x(1,5STKON + 70/3KON)+UELKON	20008860	5DM1581	15.5	67.3	71.3	9780	5400	0.164	0.6	0.27	352	17.16
3x150+3x(1,5STKON + 70/3KON)+UELKON	20042611	5DM1588	17.2	71.7	75.7	11300	6750	0.132	0.64	0.26	404	21.45
3x185+3x(1,5STKON + 95/3KON)+UELKON	20005079	5DM1585	19.1	75.1	79.1	12790	8325	0.108	0.69	0.25	461	26.46
3x240+3x(1,5STKON + 120/3KON)+UELKON			22	82.7	87.7	15900	10800	0.0817	0.77	0.25	540	34.32
3.6/6 kV NTSKCGECW0EU six control cores												
3x35+3x(2x1,5ST + 25/3KON)+UELKON	20273411	5DM1589	8.4	49	53	4620	1575	0.565	0.38	0.31	162	5.01
3x50+3x(2x1,5ST + 25/3KON)+UELKON		5DM1590	10.1	53.9	57.9	5550	2250	0.393	0.43	0.3	202	7.15
3x70+3x(2x1,5ST + 35/3KON)+UELKON	20266205	5DM1569	11.9	56.7	60.7	6760	3150	0.277	0.49	0.39	250	10.01
3x95+3x(2x1,5ST + 50/3KON)+UELKON	20226751	5DM1***	14	62	66	7900	4275	0.21	0.55	0.28	301	13.59
3x120+3x(2x1,5ST + 70/3KON)+UELKON			15.5	67.3	71.3	9800	5400	0.164	0.6	0.27	352	17.16
3x150+3x(2x1,5ST + 70/3KON)+UELKON			17.2	71	75	11100	6750	0.132	0.64	0.26	404	21.45
3x185+3x(2x1,5ST + 95/3KON)+UELKON			19.1	75.1	79.1	13000	8325	0.108	0.69	0.25	461	26.46
3x240+3x(2x1,5ST + 120/3KON)+UELKON			22	82.7	87.7	16000	10800	0.0817	0.77	0.25	540	34.32

(1) Nominal current carrying capacity for rubber cables laid on a surface, at 30°C ambient temperature (see also VDE 0298-4, Table 15). For derating-factors see tables in Technical Appendix

PROTOMONT(VO) (N)TSKCGEWOEU 3 kV

Coal cutter cables for chain operation



Application

Used as power supply connection cable for mobile equipment and machines in underground mining applications, such as coal cutting machines, etc. (VO)-Coal-Cutter cables are designed for use in cable protection chains(cable handler), which are trailed behind the machine and which absorb the thereby occurring tensile forces.

Global data

Brand	PROTOMONT(VO)
Type designation	(N)TSKCGEWOEU
Standard	DIN VDE 0250-813
Certifications / Approvals	MA – China GOST-R/-K/-B

Design features

Conductor	Finely-stranded copper conductor, tinned (class FS)
PE-Conductor	3 Double-concentric control / PE conductor elements in the outer interstices
Insulation	PROTOLON, Basic material: EPR, Compound type: 3GI3
Electrical field control	Cold strippable outer layer of semiconductive rubber compound
Core identification	Main cores: Natural color Control cores: Blue
Core arrangement	Three main cores laid-up, with double concentric control / PE conductor elements in the outer interstices
Inner sheath	Vulcanized rubber inner sheath, Basic material: EPR, Compound type: better GM1B
Outer sheath	PROTOFIRM, Basic material: synthetic elastomer compound e.g. CM, Compound type: 5GM5, Color: Red

Electrical parameters

Rated voltage	1.8/3 kV
Max. permissible operating voltage AC	2.1/3.6 kV
Max. permissible operating voltage DC	2.7/5.4 kV
AC test voltage	6 kV
AC test voltage - control cores	2 kV

Chemical parameters

Performance against fire	IEC 60322-1-2
Resistance to oil	IEC 60811-404
Weather resistance	Unrestricted use outdoors and indoors, resistant to ozone and moisture

Thermal parameters

Max. operating temperature of the conductor	90 °C
Max. short circuit temperature of the conductor	250 °C
Ambient temperature for fixed installation	min -40 °C ; max +80 °C
Ambient temperature in fully flexible operation	min -20 °C ; max +60 °C

Mechanical parameters

Max. tensile load on the conductor	15 N/mm ²
Bending radii min.	Acc. to DIN VDE 0298 part 3 2.3 x D at a tensile load of max. 5 N/mm ²
Min. distance with S-type directional changes	20 x D

PROTOMONT(V0) (N)TSKCGEWOEU 1.8/3 kV

Number of cores x cross section	Part number	MLFB Number	Conductor diameter max. mm	Outer diameter min. mm	Outer diameter max. mm	Weight (approx.) kg/km	Permissible tensile force max. N	Conductor resistance at 20°C max. Ω/km	Nominal operating capacitance μF/km	Inductance nom. mH/km	Current carrying capacity (1) A	Short Circuit Current (conductor) kA
1,8/3 kV (N)TSKCGEWOEU, three control cores												
3x25+3x(1,5STKON + 16/3KON)			7.1	37.8	40.8	2500	1125	0.795	0.28	0.34	131	3.58
3x35+3x(1,5STKON + 16/3KON)			8.4	42	45	3150	1575	0.565	0.31	0.33	162	5.01
3x50+3x(1,5STKON + 25/3KON)			10.1	45.7	48.7	3950	2250	0.393	0.36	0.31	202	7.15
3x70+3x(1,5STKON + 35/3KON)			11.9	50.9	54.9	5000	3150	0.277	0.42	0.3	250	10.01
3x95+3x(1,5STKON + 50/3KON)	20271649	5DM1603	14	58.2	62.2	6310	4275	0.21	0.45	0.29	301	13.59
3x120+3x(1,5STKON + 70/3KON)	20069403	5DM1602	15.5	60.1	64.1	7690	5400	0.164	0.49	0.28	352	17.16
3x150+3x(1,5STKON + 70/3KON)	20069404	5DM1601	17.2	65.6	69.6	9150	6750	0.132	0.54	0.28	404	21.45
3x185+3x(1,5STKON + 95/3KON)	20026143	5DM1600	19.1	69.7	73.7	10800	8325	0.108	0.59	0.27	461	26.46
3x240+3x(1,5STKON + 120/3KON)	20070763	5DM1599	22	78.9	82.9	13940	10800	0.0817	0.67	0.26	540	34.32
3x300+3x(1,5STKON + 150/3KON)	20233044	5DM1***	24.8	83.4	88.4	17000	13500	0.0654	0.74	0.25	620	42.9
1,8/3 kV (N)TSKCGEWOEU, six control cores												
3x95+3x(2x1,5ST + 50/3KON)			14	57.2	62.2	6350	4275	0.21	0.45	0.29	301	13.59
3x120+3x(2x1,5ST + 70/3KON)			15.5	62.8	66.8	7950	5400	0.164	0.49	0.28	352	17.16
3x150+3x(2x1,5ST + 70/3KON)	20160149	5DM1***	17.2	66.2	70.2	9100	6750	0.132	0.54	0.28	404	21.45
3x185+3x(2x1,5ST + 95/3KON)			19.1	70.4	74.4	10750	8325	0.108	0.59	0.27	461	26.46
3x240+3x(2x1,5ST + 120/3KON)			22	78.9	82.9	13650	10800	0.0817	0.67	0.26	540	34.32

(1) Nominal current carrying capacity for rubber cables laid on a surface, at 30°C ambient temperature (see also VDE 0298-4, Table 15). For derating-factors see tables in Technical Appendix

TENAX-CTE NSSHKCGEOEU 1 kV

Coal cutter cable for chain operation



Application

For the connection of mobile machines under very high mechanical loads, predominantly for underground mining applications, e.g. for coal-cutting machines, particularly suitable for extreme bending loads under low tensile stress, if the cable is protected against high tensile forces by the cable chain.

Global data

Brand	TENAX-CTE
Type designation	NSSHKCGEOEU
Standard	Based on DIN VDE 0250 part 812
Certifications / Approvals	EAC Certificate

Design features

Conductor	Finely stranded conductor of tinned copper wires (0,3mm) in special flexible design
PE-Conductor	Distributed as a spinning of tinned copper wires and a conductive tape
Insulation	rubber compound EPR-3GI3, colored
Core identification	Main cores: Black, Grey, Brown Control cores: Blue
Pilot conductor	Pilot cores with copper/steel conductors capable of expansion and compression, EPR-insulation
Core arrangement	Cores cabled around semi-conductive cradle
Inner sheath	Made of semi-conductive rubber
Torsion protection	Polyester anti-torsion braid
Outer sheath	Rubber compound type: 5GM5, acc. to DIN VDE 0207 part 21, Color: Yellow

Electrical parameters

Rated voltage	0.6/1 kV (600/1000V)
Max. permissible operating voltage AC	0.7/1.2 kV
Max. permissible operating voltage DC	0.9/1.8 kV
AC test voltage	3 kV
AC test voltage - control cores	2 kV

Chemical parameters

Performance against fire	IEC 60332-1-2
Resistance to oil	IEC 60811-404
Weather resistance	Unrestricted use outdoors and indoors, resistant to ozone and moisture

Thermal parameters

Max. operating temperature of the conductor	90 °C
Max. short circuit temperature of the conductor	250 °C
Ambient temperature for fixed installation	min -40°C; max 80°C
Ambient temperature in fully flexible operation	min -20°C; max 60°C

Mechanical parameters

Bending radii min.	5 x D at a tensile load of max. 15 N/mm ² 2.3 x D at a tensile load of max. 5 N/mm ²
--------------------	---

TENAX-CTE NSSHKCGOEU 0.6/1 kV

Number of cores x cross section	Part number	Conductor diameter max. mm	Outer diameter min. mm	Outer diameter max. mm	Weight (approx.) kg/km	Permissible tensile force max. N	Conductor resistance at 20°C max. Ω/km	Nominal operating capacitance μF/km	Inductance nom. mH/km	Current carrying capacity (1) A	Short Circuit Current (conductor) kA
3x25 + 3x(1,5ST + 16/3)		7	36	40	2790	1125	0.795	0.52	0.29	131	3.58
3x35 + 3x(1,5ST + 16/3)	20076049	8.2	38	42	2620	1575	0.565	0.59	0.28	162	5.01
3x50 + 3x(1,5ST + 25/3)	20076047	10.2	43	48	3600	2250	0.393	0.62	0.27	202	7.15
3x70 + 3x(1,5ST + 35/3)	20099802	12.2	44	49	4180	3150	0.277	0.72	0.26	250	10.01
3x95 + 3x(1,5ST + 50/3)	20099803	13.2	53	57	5490	4275	0.21	0.69	0.26	301	13.59
3x120 + 3x(1,5ST + 70/3)		15.2	58	63	8300	5400	0.164	0.86	0.25	352	17.16
3x150 + 3x(1,5ST + 70/3)		17.1	62	68	9300	6750	0.132	0.78	0.25	404	21.45

(1) Nominal current carrying capacity for rubber cables laid on a surface, at 30°C ambient temperature (see also VDE 0298-4, Table 15). For derating-factors see tables in Technical Appendix

PROTOMONT(Z) NSSHKCGEOEU 1 kV

Coal cutter cables for trailing operations



Application

Used as power supply connection cable for mobile equipment in underground machine applications, such as coal shearer, roadheader, TBM's or scoops (LHDs). (Z)-Coal-Cutter cables are designed for free trailing operation and due to their special construction may be trailed for considerable distances behind the machine during operation.

Global data

Brand	PROTOMONT(Z)
Type designation	NSSHKCGEOEU
Standard	DIN VDE 0250-812
Certifications / Approvals	MSHA P-189-4 BAS Bosnia-Herzegovina TR-Certificate EAC-Certificate

Design features

Conductor	Very finely stranded copper conductor, tinned (class FS)
PE-Conductor	Double-concentric control/PE wire spinning in the outer interstice
Insulation	PROTOLON, Basic material: EPR, Compound type: 3GI3
Core identification	Main cores: Colored, Black, Grey, Brown; Control cores: Blue
Core arrangement	Three main conductors laid-up, with double-concentric control/PE conductor elements in the outer interstice
Inner sheath	Vulcanized rubber inner sheath, Basic material: EPR, Compound type: GM1B
Armouring	Braid of steel strands in a vulcanized bond between inner and outer sheath
Outer sheath	PROTOFIRM, Basis:synthetic elastomer compound e.g. CM, Compound type: 5GM5, Color: Yellow

Electrical parameters

Rated voltage	0.6/1 kV (600/1000V)
Max. permissible operating voltage AC	0.7/1.2 kV
Max. permissible operating voltage DC	0.9/1.8 kV
AC test voltage	3 kV
AC test voltage - control cores	2 kV

Chemical parameters

Performance against fire	IEC 60332-1-2
Resistance to oil	IEC 60811-404
Weather resistance	Unrestricted use outdoors and indoors, resistant to ozone and moisture

Thermal parameters

Max. operating temperature of the conductor	90 °C
Max. short circuit temperature of the conductor	250 °C
Ambient temperature for fixed installation	min -40°C; max +80°C
Ambient temperature in fully flexible operation	min -20°C; max +60°C

Mechanical parameters

Minimum Breaking load of steel braid	45 kN
Max. tensile load on the conductor	40 N/mm ²
Torsional stress +/-	10 °/m
Travel speed	150 m/min

PROTOMONT(Z) NSSHKCGEOEU 0.6/1 kV

Number of cores x cross section	Part number	MLFB Number	Conductor diameter max. mm	Outer diameter min. mm	Outer diameter max. mm	Weight (approx.) kg/km	Permissible tensile force max. N	Conductor resistance at 20°C max. Ω/km	Nominal operating capacitance μF/km	Inductance nom. mH/km	Current carrying capacity (1) A	Short Circuit Current (conductor) kA
3x25+3x(1,5STKON + 16/3KON)			7.1	39.2	42.2	2700	3000	0.795	0.37	0.33	131	3.58
3x35+3x(1,5STKON + 16/3KON)			8.4	40.8	43.8	3100	4200	0.565	0.42	0.3	162	5.01
3x50+3x(1,5STKON + 25/3KON)			10.1	46.2	49.2	4000	6000	0.393	0.45	0.28	202	7.15
3x70+3x(1,5STKON + 35/3KON)			11.9	49.6	53.6	5100	8400	0.277	0.52	0.27	250	10.01
3x95+3x(1,5STKON + 50/3KON)			14	56.8	60.8	6700	11400	0.21	0.55	0.27	301	13.59
3x120+3x(1,5STKON + 70/3KON)			15.5	60.6	64.6	8000	14400	0.164	0.59	0.26	352	17.16
3x150+3x(1,5STKON + 70/3KON)	20235364	5DM1516	17.6	67	71	9620	18000	0.132	0.61	0.26	404	21.45
3x185+3x(1,5STKON + 95/3KON)			19.1	72	76	11500	22200	0.108	0.63	0.26	461	26.46
3x240+3x(1,5STKON + 120/3KON)			22	80.4	85.4	14600	28800	0.0817	0.67	0.25	540	34.32
3x300+3x(1,5STKON + 150/3KON)			24.8	89.1	94.1	18700	36000	0.0654	0.7	0.25	620	42.9

(1) Nominal current carrying capacity for rubber cables laid on a surface, at 30°C ambient temperature (see also VDE 0298-4, Table 15). For derating-factors see tables in Technical Appendix

TENAX-LK NTSKCGEWOEU 1 kV

Loader reeling cable with pilot cores, twist protection and central strain relief element



Application

These cables are intended for mining reeling applications under very high mechanical loads, e.g. fast moving machines like shuttle cars etc. where frequent winding and unwinding is required during operation, in particular with simultaneous tensile strain and/or torsion stress and/or forced guidance of the cable.

Global data

Brand	TENAX-LK
Type designation	NTSKCGEWOEU
Standard	DIN VDE 0250-813
Certifications / Approvals	EAC-Certificate

Design features

Conductor	Tinned copper, extra finely stranded (class 5), according to DIN VDE 0295
Insulation	Rubber compound type 3GI3 acc. to DIN VDE 0207 part 20 Separator: Polyester tape
Special Pilot / PE element	Copper and steel conductor capable of expansion and compression covert with EPR insulation. Earth core as a spinning of tinned copper bunches covered with semi-conductive tape.
Core identification	Core colors: Brown, Black, Grey Control core: Blue
Core arrangement	Cores laid up around conductive central cradle separator with aramid rope
Inner sheath	Semi conductive inner sheath
Torsion protection	Extremely tear-resistant reinforcing tape, which prevents sheath movement.
Outer sheath	Outer sheath of black chlorinated rubber compound 5GM5, abrasion and tear-resistant, oil-resistant and flame retardant

Electrical parameters

Rated voltage	0.6/1 kV (600/1000V)
Max. permissible operating voltage AC	0.7/1.2 kV
Max. permissible operating voltage DC	0.9/1.8 kV
AC test voltage	3 kV
AC test voltage - control cores	2 kV

Chemical parameters

Performance against fire	IEC 60332-1-2
Resistance to oil	IEC 60811-404
Weather resistance	Unrestricted use outdoors and indoors, resistant to ozone, UV and moisture

Thermal parameters

Max. operating temperature of the conductor	90 °C
Max. short circuit temperature of the conductor	250 °C
Ambient temperature for fixed installation	min -40 °C ; max +80 °C
Ambient temperature in fully flexible operation	min -25 °C ; max +60 °C

Mechanical parameters

Max. tensile load on the conductor	30 N/mm ²
Torsional stress +/-	100 %/m
Bending radii min.	Acc. to DIN VDE 0298 part 3
Travel speed	max. 160 m/min

TENAX-LK NTSKCGEWOEU 0.6/1 kV

Number of cores x cross section	Part number	Conductor diameter max. mm	Outer diameter min. mm	Outer diameter max. mm	Weight (approx.) kg/km	Permissible tensile force max. N	Conductor resistance at 20°C max. Ω/km	Nominal operating capacitance μF/km	Inductance nom. mH/km	Current carrying capacity (1) A	Short Circuit Current (conductor) kA
3x16+3x(1,5ST+16/3)	20074226	5	30.1	32.6	1525	720	1.24	1.5	0.23	99	2.29
3x25 + 3x(1,5ST + 16/3)	20271566	6.2	37	39.5	2150	1125	0.8	1.56	0.22	131	3.58
3x35 + 3x(1,5ST + 25/3)		7.5	39.8	42.3	2575	1575	0.565	1.67	0.22	162	5.01
3x50 + 3x(1,5ST + 25/3)		9	42.9	45.4	3150	2250	0.393	1.79	0.22	202	7.15
3x70 + 3x(1,5ST + 35/3)		10.6	46.4	48.9	4000	3150	0.277	1.92	0.22	250	10.01
3x95 + 3x(1,5ST + 50/3)		12.6	53.2	56.7	5525	4275	0.21	1.84	0.22	301	13.59
3x16+2x10+1x1,5ST	20135821	5	32	36	1900	720	1.24	1.36	0.23	99	2.29
3x25+2x10+1x1,5ST		6.2	36	40	2350	1125	0.8	1.52	0.22	131	3.58

(1) Nominal current carrying capacity for rubber cables laid on a surface, at 30°C ambient temperature (see also VDE 0298-4, Table 15). For derating-factors see tables in Technical Appendix

PROTOMONT(S) (N)SSHCGE0EU 1 kV

Underground reeling cable



Application

For frequently changing dynamic loads, such as reeling cables for scoops (LHDs) in underground mines, suitable for mono-spiral reels and cylindrical reels. High tensile strength through central reinforcement element and very high abrasion and tear resistance of the outer sheath.

Global data

Brand	PROTOMONT(S)
Type designation	(N)SSHCGE0EU
Standard	Based on DIN VDE 0250 part 812
Certifications / Approvals	MA - China TR-Certificate EAC-Certificate

Design features

Conductor	Electrolytic copper, tinned, very finely stranded (class FS)
PE-Conductor	Double concentric control/earth wire spinning in outer interstices
Insulation	Basic material: EPR, Compound type: 3GI3
Core identification	Black, Brown, Grey
Core arrangement	Three main cores stranded with three control/earth cores in outer interstices
Support element	Central support element made of aramid yarns embedded in cradle separator
Inner sheath	Basic material: EPR, Compound type: GM1B
Torsion protection	Reinforced braid of polyester threads in a vulcanized bond between inner and outer sheath, Surface covered: approx. 25%
Outer sheath	Basic material: Synthetic elastomer compound e.g. CR, Compound type: 5GM5, Color: Yellow

Electrical parameters

Rated voltage	$U_0/U = 0,6/1$ kV, also permitted for $U_0/U = 640/1140$ V
Max. permissible operating voltage AC	0.7/1.2 kV
Max. permissible operating voltage DC	0.9/1.8 kV
AC test voltage	3 kV
AC test voltage - control cores	2 kV

Chemical parameters

Performance against fire	IEC 60332-1-2
Resistance to oil	IEC 60811-404
Weather resistance	Unrestricted use outdoors and indoors, resistant to ozone, UV and moisture

Thermal parameters

Max. operating temperature of the conductor	90 °C
Max. short circuit temperature of the conductor	250 °C
Ambient temperature for fixed installation	min -40 °C ; max +80 °C
Ambient temperature in fully flexible operation	min -25 °C ; max +60 °C

Mechanical parameters

Max. tensile load on the conductor	30 N/mm ²
Torsional stress +/-	50 %/m
Bending radii min.	4 x D
Min. distance with S-type directional changes	20 x D
Travel speed	Max. 160 m/min
Additional tests	Reversed bending test, roller bending test

PROTOMONT(S) (N)SSHCGE0EU 0.6/1 kV

Number of cores x cross section	Part number	MLFB Number	Conductor diameter max. mm	Outer diameter min. mm	Outer diameter max. mm	Weight (approx.) kg/km	Permissible tensile force max. N	Conductor resistance at 20°C max. Ω/km	Nominal operating capacitance μF/km	Inductance nom. mH/km	Current carrying capacity (1) A	Short Circuit Current (conductor) kA
3x16 + 3x(1,5STKON + 10/3KON)	20025111	5DM1150	5.8	31.1	34.4	1820	1440	1.24	0.5	0.3	99	2.29
3x25 + 3x(1,5STKON + 16/3KON)	20025108	5DM1151	7.3	36.3	39.3	2500	2250	0.795	0.52	0.29	131	3.58
3x35 + 3x(1,5STKON + 16/3KON)	20165213	5DM1142	8.4	41.2	44.2	2990	3150	0.565	0.6	0.28	162	5.01
3x50 + 3x(1,5STKON + 25/3KON)	20218401	5DM1***	10.3	44.5	47.5	3800	4500	0.393	0.61	0.27	202	7.15
3x70 + 3x(1,5STKON + 35/3KON)	20236433	5DM1***	12	47.3	50.3	4500	6300	0.277	0.7	0.26	250	10.01
3x95 + 3x(1,5STKON + 50/3KON)	20230582	5DM1***	14	54.8	58.8	5300	8550	0.21	0.72	0.26	301	13.59
3x120 + 3x(1,5STKON + 70/3KON)		5DM1***	15.8	58.7	62.7	6100	10800	0.164	0.79	0.25	352	17.16

(1) Nominal current carrying capacity for rubber cables laid on a surface, at 30°C ambient temperature (see also VDE 0298-4, Table 15). For derating-factors see tables in Technical Appendix

CORDAFLEX(S) NSHTOEU 1kV

LHD-cables for scoop operations



Application

For frequently changing dynamic loads, such as reeling cables for scoops (LHDs) in underground mines, suitable for mono-spiral reels and cylindrical reels.

Global data

Brand	CORDAFLEX(S)
Type designation	NSHTOEU
Standard	DIN VDE 0250-814
Certifications / Approvals	MSHA P-189-3 TR-Certificate EAC-Certificate

Design features

Conductor	Electrolytic copper, very finely stranded (class FS)
Insulation	Basic material: EPR, Compound type: 3GI3
Core identification	Power cores: Black, Grey, Brown or natural coloring with black figures; Protective earth: Green-Yellow
Support element	Central support element made of aramid yarns with rubber covering
Inner sheath	Compound type: 5GM5, Color: Yellow or Orange
Torsion protection	Reinforced braid of polyester threads in a vulcanized bond between inner and outer sheath, Surface covered: approx. 25%
Outer sheath	Basic material: synthetic elastomer compound e.g. CR, Compound type: 5GM5, Color: Yellow or Orange

Electrical parameters

Rated voltage	$U_0/U = 0,6/1$ kV, also permitted for $U_0/U = 640/1140$ V
Max. permissible operating voltage AC	0.7/1.2 kV
Max. permissible operating voltage DC	0.9/1.8 kV
AC test voltage - main cores	2.5 kV (5 Min.)
AC test voltage - control cores	2 kV

Chemical parameters

Performance against fire	EN 60332-1-2, IEC 60332-1-2
Resistance to oil	EN 60811-404, IEC 60811-404
Weather resistance	Unrestricted use outdoors and indoors, resistant to ozone, UV and moisture

Thermal parameters

Max. operating temperature of the conductor	90 °C
Max. short circuit temperature of the conductor	250 °C
Ambient temperature for fixed installation	min -40 °C ; max +80 °C
Ambient temperature in fully flexible operation	min -25 °C ; max +60 °C

Mechanical parameters

Max. tensile load on the conductor	30 N/mm ²
Torsional stress +/-	25 °/m
Bending radii min.	Acc. to DIN VDE 0298 part 3
Min. distance with S-type directional changes	20xD
Travel speed	max. 160 m/min
Additional tests	Reversed bending test, roller bending test

CORDAFLEX(S) NSHTOEU 0.6/1kV

Number of cores x cross section	Colour	Part number	MLFB Number	Conductor diameter max. mm	Outer diameter min. mm	Outer diameter max. mm	Weight (approx.) kg/km	Permissible tensile force max. N	Conductor resistance at 20°C max. Ω/km	Nominal operating capacitance μF/km	Inductance nom. mH/km	Current carrying capacity (1) A	Short Circuit Current (conductor) kA
4x16(6kN)	or	20004221	5DH3951	5.8	28	31	1450	1920	1.24	0.5	0.3	99	2.29
4x16(6kN)	ye		5DH3951	5.8	28	31	1450	1920	1.24	0.5	0.3	99	2.29
4x25(6kN)	ye	20041914	5DH3967	7.3	34	37	2260	3000	0.795	0.54	0.29	131	3.58
4x35(12kN)	ye	20151818	5DH3952	8.4	38	41	2930	4200	0.565	0.6	0.28	162	5.01
4x50(12kN)	ye		5DH3953	10.3	44.8	47.8	4000	6000	0.393	0.62	0.27	202	7.15
4x50(30kN)	ye	20004210	5DH3842	10.3	42	44	3660	6000	0.393	0.62	0.27	202	7.15
4x70(20kN)	ye	20004222	5DH3959	12	48.3	51.3	5050	8400	0.277	0.71	0.26	250	10.01
4x95(50kN)	ye	20004219	5DH3942	14	51	53	6030	11400	0.21	0.72	0.26	301	13.59

(1) Nominal current carrying capacity for rubber cables laid on a surface, at 30°C ambient temperature (see also VDE 0298-4, Table 15). For derating-factors see tables in Technical Appendix

PROTOMONT(M+) (N)SHOEU-J 1 kV

Reeling cables for drills and LHD

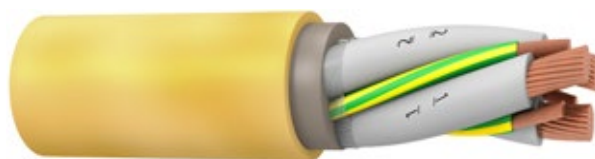

Application

PROTOMONT(M+) reeling cables are used as power supply cables for the use with underground mining equipment. The cables are designed for frequently changing dynamic loads, such as reeling cables for drills and LHD's. The cables withstand high mechanical stress caused by reeling application and the abrasion to be expected in trailing operations. PROTOMONT(M+) is suitable for use with mono-spiral reels and cylindrical reels.

Global data

Brand	PROTOMONT(M)
Type designation	(N)SHOEU-J
Standard	Based on DIN VDE 0250 part 812

Design features

Conductor	Bare electrolytic copper, finely stranded (class 5)
Insulation	PROTOLON, Basic material: EPR, Compound type: 3GI3
Core identification	Natural colouring with black digits printed consecutively
Core arrangement	Three main conductors laid-up together with the protective-earth conductor, from 50 mm ² with protective-earth conductor split into three in the outer interstices
Inner sheath	Basic material: EPR, Special compound
Outer sheath	Basic material: Chlorinated rubber, Compound type: 5GM5, Color: Yellow

Electrical parameters

Rated voltage	0.6/1 kV (600/1000V)
Max. permissible operating voltage AC	0.7/1.2 kV
Max. permissible operating voltage DC	0.9/1.8
AC test voltage - main cores	3 kV (5 Min.)
AC test voltage - control cores	2 kV

Chemical parameters

Performance against fire	EN 60332-1-2, IEC 60332-1-2
Resistance to oil	EN 60811-404, IEC 60811-404
Weather resistance	Unrestricted use outdoors and indoors, resistant to ozone, UV and moisture

Thermal parameters

Max. operating temperature of the conductor	90 °C
Max. short circuit temperature of the conductor	250 °C
Ambient temperature for fixed installation	min -40 °C ; max +80 °C
Ambient temperature in fully flexible operation	min -25 °C ; max +60 °C

Mechanical parameters

Max. tensile load on the conductor	15 N/mm ²
Torsional stress +/-	25 °/m
Bending radii min.	Acc. to DIN VDE 0298 part 3
Travel speed	max. 60 m/min

PROTOMONT(M+) (N)SHOEU-J 0,6/1 kV

Number of cores x cross section	Part number	MLFB Number	Conductor diameter max. mm	Outer diameter min. mm	Outer diameter max. mm	Weight (approx.) kg/km	Permissible tensile force max. N	Conductor resistance at 20°C max. Ω/km	Nominal operating capacitance μF/km	Inductance nom. mH/km	Current carrying capacity (1) A	Short Circuit Current (conductor) kA
3x50+3x25/3	20221569	5DL4***	9.4	30.3	33.3	2320	2250	0.386	0.54	0.25	202	7.15
3x70+3x35/3	20016040	5DL4536	11.1	36.2	39.2	3430	3150	0.272	0.61	0.24	250	10.01
3x95+3x50/3	20015116	5DL4527	12.9	40.9	43.9	4480	4275	0.206	0.64	0.24	301	13.59
3x120+3x70/3	20008590	5DL4528	14.6	45	48	5610	5400	0.161	0.72	0.23	352	17.16
3x150+3x70/3		5DL4***	16.5	50.8	54.8	6930	6750	0.129	0.72	0.23	404	21.45
3x185+3x95/3	20273440	5DL4***	17.9	54.6	58.6	8100	8325	0.106	0.71	0.23	461	26.46
3x240+3x120/3	20008475	5DL4529	20.7	62.2	66.2	10740	10800	0.08	0.76	0.23	540	34.32
3x300+3x150/3		5DL4***	23.5	68.7	72.7	12900	13500	0.064	0.78	0.23	620	42.9

(1) Nominal current carrying capacity for rubber cables laid on a surface, at 30°C ambient temperature (see also VDE 0298-4, Table 15). For derating-factors see tables in Technical Appendix

PROTOMONT NTSKCGECWOEU – Festoon 6 kV

Underground festoon cable



Application

As power feeder cable in underground mines and in tunnel sites. The cables are used in underground festoon systems for the power supply of mobile transformer and shiftable units in underground mining applications.

Global data

Brand	PROTOMONT
Type designation	NTSKCGECWOEU
Standard	DIN VDE 0250-813
Certifications / Approvals	MA – China WUG – Poland BAS-Certificate Fire Certificate of Russian Federation GOST-R/-B/-K

Design features

Conductor	Finely stranded copper conductor, tinned (Class 5)
Insulation	PROTOLON, Basic material: EPR, Compound type: 3GI3
Electrical field control	Inner semiconductive layer of semiconductive rubber, outer semiconductive layer of tapes
Core identification	Power cores: Natural color, Control cores: Blue
Arrangement of PE-conductor	Concentric spinning of copper wires over each control core element in the outer interstices
Inner sheath	Basic material: EPR, Compound type: GM1B
Monitoring conductor	Semi-conductive tape and open-lay spinning of steel/copper wires
Outer sheath	PROTOFIRM, Basic material: synthetic elastomer compound e.g. CR, Compound type: 5GM5, Color: Red

Electrical parameters

Rated voltage	3.6/6 kV
Max. permissible operating voltage AC	4.2/7.2 kV
Max. permissible operating voltage DC	5.4/10.8 kV
AC test voltage	11 kV
AC test voltage - control cores	2 kV

Chemical parameters

Performance against fire	IEC 60332-1-2
Resistance to oil	IEC 60811-404.
Weather resistance	Unrestricted use outdoors and indoors, resistant to ozone, UV and moisture

Thermal parameters

Max. operating temperature of the conductor	90 °C
Max. short circuit temperature of the conductor	250 °C
Ambient temperature for fixed installation	min -40 °C ; max +80 °C
Ambient temperature in fully flexible operation	min -25 °C ; max +60 °C

Mechanical parameters

Max. tensile load on the conductor	15 N/mm ²
Bending radii min.	Acc. to DIN VDE 0298 part 3

PROTOMONT NTSKCGECW0EU - Festoon 3.6/6 kV

Number of cores x cross section	Part number	MLFB Number	Conductor diameter max. mm	Outer diameter min. mm	Outer diameter max. mm	Weight (approx.) kg/km	Permissible tensile force max. N	Conductor resistance at 20°C max. Ω/km	Nominal operating capacitance μF/km	Inductance nom. mH/km	Current carrying capacity (1) A	Short Circuit Current (conductor) kA
3x35+3x(1,5STKON + 25/3KON)+UELKON	20005043	5DM1078	8.2	47.6	50.6	3870	1575	0.565	0.28	0.3	162	5.01
3x50+3x(1,5STKON + 25/3KON)+UELKON	20005040	5DM1069	9.8	50.6	54.6	4600	2250	0.393	0.33	0.29	202	7.15
3x70+3x(1,5STKON + 35/3KON)+UELKON	20005041	5DM1070	11.3	55	59	5640	3150	0.277	0.37	0.28	250	10.01
3x95+3x(1,5STKON + 50/3KON)+UELKON	20005042	5DM1076	13.4	60.3	64.3	6910	4275	0.21	0.42	0.27	301	13.59
3x120 + 3x(1,5STKON + 70/3KON) + 6ÜLKON	20007844	5DM1085	15.1	65.8	69.8	8410	5400	0.164	0.46	0.26	352	17.16
3x150 + 3x(1,5STKON + 70/3KON) + 6ÜLKON	20053570	5DM1089	16.8	69.7	73.7	9700	6750	0.132	0.51	0.25	404	21.45
3x185+3x(1,5STKON + 95/3KON)+UELKON	20080424	5DM1187	19	70	74	12770	8325	0.108	0.59	0.25	461	26.46
NTSKCGECW0EU 3.6/6kV, six-cores design												
6X35+6X35/6E + 1X(6X1,5ST)+UELKON	20227551	5DM1191	8.2	60.2	64.2	6180	3150	0.565	0.34	0.44	110	5.01
6X50+6X50/6E + 1X(6X1,5ST)+UELKON	20269961	5DM1192	9.8	67.2	71.2	7870	4500	0.393	0.45	0.39	137	7.15
6X70+6X70/6E + 1X(6X1,5ST)+UELKON	20111554	5DM1193	11.3	71.4	75.4	9670	6300	0.277	0.58	0.35	170	10.01
6X95+6X95/6E + 1X(6X1,5ST)+UELKON		5DM1***	13.4	80.2	84.2	11900	8550	0.21	0.7	0.33	205	13.59

(1) Nominal current carrying capacity for rubber cables laid on a surface, at 30°C ambient temperature (see also VDE 0298-4, Table 15). For derating-factors see tables in Technical Appendix

SUPROMONT (N)3GHSSYCY 6 kV – 30 kV

Rubber insulated MV flexible cables for underground use



Application

As feeder cable for power supply of shiftable MV equipment, e.g. compressure resistant transformers, for underground mining applications as well as for tunnel sites.

Global data

Brand	SUPROMONT
Type designation	(N)3GHSSYCY
Standard	based on DIN VDE 0250 part 605
Certifications / Approvals	VDE certificate of conformity

Design features

Conductor	Bare electrolytic copper, finely stranded (class 5)
PE-Conductor	Individually laid-up concentrically around each main core
Insulation	PROTOLON, Basic material: EPR, Compound type: Special compound, better 3GI3
Electrical field control	Inner and outer semiconductive layer of semiconductive rubber, for 6kV outer semiconductive layer only
Core identification	Main cores: Natural color with black semiconductive layer, Control cores: Black with white digits
Core arrangement	Three main cores laid-up, one control core in each outer interstice
Inner sheath	PVC based plastic compound, type: DMV6
Monitoring conductor	Conductive tape and overall concentric copper wire spinning
Intermediate sheath	PVC based plastic compound, type: DMV6
Armouring	Braid of galvanized steel wires
Outer sheath	PVC-based thermoplastic compound, type: DMV6, Color: Red

Electrical parameters

Rated voltage	3.6/6 kV	6/10 kV	8.7/15 kV	12/20 kV	14/25 kV	18/30 kV
Max. permissible operating voltage AC	4.2/7.2 kV	6.9/12 kV	10.4/18 kV	13.9/24 kV	17.3/30 kV	20.8/36 kV
Max. permissible operating voltage DC	5.4/10.8 kV	9/18 kV	13.5/27 kV	18/36 kV	22.5/45 kV	27/54 kV
AC test voltage	11 kV	17 kV	24 kV	29 kV	43 kV	43 kV
AC test voltage - control cores	2 kV	2 kV	2 kV	2 kV	2 kV	2 kV

Chemical parameters

Performance against fire	IEC 60332-1-2
Weather resistance	Unrestricted use indoors and in underground mines according to DIN VDE 0118, resistant to ozone and moisture

Thermal parameters

Max. operating temperature of the conductor	90 °C
Max. short circuit temperature of the conductor	250 °C
Ambient temperature for fixed installation	min -40 °C ; max +80 °C
Ambient temperature in fully flexible operation	min 5 °C ; max +60 °C

Mechanical parameters

Max. tensile load on the conductor	15 N/mm ²
Bending radii min.	Acc. to DIN VDE 0298 part 3

SUPROMONT (N)3GHSSYCY 3.6/6 kV

Number of cores x cross section	Part number	MLFB Number	Conductor diameter max. mm	Outer diameter min. mm	Outer diameter max. mm	Weight (approx.) kg/km	Permissible tensile force max. N	Conductor resistance at 20°C max. Ω/km	Nominal operating capacitance μF/km	Inductance nom. mH/km	Current carrying capacity (1) A	Short Circuit Current (conductor) kA
3x25+3x16/3E + 3x2,5ST+UEL	20161631	5DM2031	6.4	42.7	45.7	3180	1125	0.78	0.36	0.32	131	3.58
3x35+3x16/3E + 3x2,5ST+UEL	20112385	5DM2032	7.6	45.3	48.3	3700	1575	0.554	0.41	0.3	162	5.01
3x50+3x25/3E + 3x2,5ST+UEL	20042591	5DM2033	9.1	49.5	53.5	4730	2250	0.386	0.47	0.29	202	7.15
3x70+3x35/3E + 3x2,5ST+UEL	20203072	5DM2034	10.8	53.2	57.2	5720	3150	0.272	0.53	0.28	250	10.01
3x95+3x50/3E + 3x2,5ST+UEL	20049961	5DM2035	12.7	58.2	62.2	7010	4275	0.206	0.61	0.27	301	13.59
3x120+3x70/3E + 3x2,5ST+UEL	20203073	5DM2036	14.3	62.7	66.7	8311	5400	0.161	0.67	0.26	352	17.16
3x150+3x70/3E + 3x2,5ST+UEL		5DM2	16	67.6	71.6	9634	6750	0.129	0.74	0.25	404	21.45
3x185+3x120/3E + 3x2,5ST+UEL		5DM2	17.7	71.7	75.7	11202	8325	0.106	0.8	0.25	461	26.46

SUPROMONT (N)3GHSSYCY 6/10 kV

Number of cores x cross section	Part number	MLFB Number	Conductor diameter max. mm	Outer diameter min. mm	Outer diameter max. mm	Weight (approx.) kg/km	Permissible tensile force max. N	Conductor resistance at 20°C max. Ω/km	Nominal operating capacitance μF/km	Inductance nom. mH/km	Current carrying capacity (1) A	Short Circuit Current (conductor) kA
3x25+3x16/3E + 3x2,5ST+UEL	20156248	5DM2121	6.4	45.7	48.7	3580	1125	0.78	0.32	0.33	131	3.58
3x35+3x16/3E + 3x2,5ST+UEL	20005081	5DM2122	7.6	47.8	50.8	4130	1575	0.554	0.36	0.31	162	5.01
3x50+3x25/3E + 3x2,5ST+UEL	20005082	5DM2123	9.1	50.8	54.8	4890	2250	0.386	0.42	0.3	202	7.15
3x70+3x35/3E + 3x2,5ST+UEL	20133422	5DM2124	10.8	55.1	59.1	5680	3150	0.272	0.47	0.28	250	10.01
3x95+3x50/3E + 3x2,5ST+UEL	20005083	5DM2125	12.7	60	64	7130	4275	0.206	0.54	0.27	301	13.59
3x120+3x70/3E + 3x2,5ST+UEL	20005084	5DM2126	14.3	63.9	67.9	8450	5400	0.161	0.59	0.26	352	17.16
3x150+3x70/3E + 3x2,5ST+UEL	20275552	5DM2***	16	68.9	72.9	9840	6750	0.129	0.66	0.25	404	21.45
3x185+3x120/3E + 3x2,5ST+UEL		5DM2	17.7	73	77	11408	8325	0.106	0.74	0.25	461	26.46

(1) Nominal current carrying capacity for rubber cables laid on a surface, at 30°C ambient temperature (see also VDE 0298-4, Table 15). For derating-factors see tables in Technical Appendix

SUPROMONT (N)3GHSSYCY 8.7/15 kV

Number of cores x cross section	Part number	MLFB Number	Conductor diameter max. mm	Outer diameter min. mm	Outer diameter max. mm	Weight (approx.) kg/km	Permissible tensile force max. N	Conductor resistance at 20°C max. Ω/km	Nominal operating capacitance μF/km	Inductance nom. mH/km	Current carrying capacity (1) A	Short Circuit Current (conductor) kA
3x25+3x16/3E + 3x2,5ST+UEL		5DM2131	6.4	49.1	53.1	3985	1125	0.78	0.22	0.36	139	3.58
3x35+3x16/3E + 3x2,5ST+UEL		5DM2132	7.6	50.4	54.4	4481	1575	0.554	0.29	0.33	172	5.01
3x50+3x25/3E + 3x2,5ST+UEL	20194633	5DM2133	9.1	53.9	57.9	5300	2250	0.386	0.33	0.31	215	7.15
3x70+3x35/3E + 3x2,5ST+UEL	20227835	5DM2134	10.8	57.6	61.6	6380	3150	0.272	0.38	0.3	265	10.01
3x95+3x50/3E + 3x2,5ST+UEL		5DM2135	12.7	63.1	67.1	7652	4275	0.206	0.43	0.29	319	13.59
3x120+3x70/3E + 3x2,5ST+UEL	20181158	5DM2136	14.3	67.4	71.4	8940	5400	0.161	0.47	0.28	371	17.16
3x150+3x70/3E + 3x2,5ST+UEL	20269302	5DM2***	16	72	76	10400	6750	0.129	0.54	0.27	428	21.45
3x185+3x120/3E + 3x2,5ST+UEL		5DM2	17.7	75.6	79.6	11865	8325	0.106	0.58	0.26	488	26.46

SUPROMONT (N)3GHSSYCY 12/20 kV

Number of cores x cross section	Part number	MLFB Number	Conductor diameter max. mm	Outer diameter min. mm	Outer diameter max. mm	Weight (approx.) kg/km	Permissible tensile force max. N	Conductor resistance at 20°C max. Ω/km	Nominal operating capacitance μF/km	Inductance nom. mH/km	Current carrying capacity (1) A	Short Circuit Current (conductor) kA
3x25+3x16/3E + 3x2,5ST+UEL	20137435	5DM2211	6.4	52.6	56.6	3900	1575	0.554	0.2	0.37	172	5.01
3x35+3x16/3E + 3x2,5ST+UEL	20015843	5DM2212	7.6	53.6	57.6	5090	1125	0.7839	0.25	0.35	139	3.58
3x50+3x25/3E + 3x2,5ST+UEL	20007713	5DM2213	9.1	56.8	60.8	5730	2250	0.386	0.28	0.33	215	7.15
3x70+3x35/3E + 3x2,5ST+UEL	20217439	5DM2214	10.8	61	65	6840	3150	0.272	0.32	0.31	265	10.01
3x95+3x50/3E + 3x2,5ST+UEL	20111613	5DM2215	12.7	66	70	8080	4275	0.206	0.36	0.3	319	13.59
3x120+3x70/3E + 3x2,5ST+UEL	20113362	5DM2216	14.3	69.9	73.9	9650	5400	0.161	0.39	0.29	371	17.16
3x150+3x70/3E + 3x2,5ST+UEL	20135152	5DM2***	16	71	75	10932	6750	0.129	0.43	0.28	428	21.45
3x185+3x120/3E + 3x2,5ST+UEL		5DM2	17.7	78.7	82.7	12417	8325	0.106	0.47	0.27	488	26.46

(1) Nominal current carrying capacity for rubber cables laid on a surface, at 30°C ambient temperature (see also VDE 0298-4, Table 15). For derating-factors see tables in Technical Appendix

SUPROMONT (N)3GHSSYCY 14/25 kV

Number of cores x cross section	Part number	MLFB Number	Conductor diameter max. mm	Outer diameter min. mm	Outer diameter max. mm	Weight (approx.) kg/km	Permissible tensile force max. N	Conductor resistance at 20°C max. Ω/km	Nominal operating capacitance μF/km	Inductance nom. mH/km	Current carrying capacity (1) A	Short Circuit Current (conductor) kA
3x35+3x16/3E + 3x2,5ST+UEL		5DM2	7.6	57.6	61.6	5502	1575	0.554	0.21	0.37	172	5.01
3x50+3x25/3E + 3x2,5ST+UEL	20292042	5DM2	9.1	61.4	65.4	6517	2250	0.386	0.24	0.35	215	7.15
3x70+3x35/3E + 3x2,5ST+UEL		5DM2	10.8	65	69	7526	3150	0.272	0.27	0.33	265	10.01
3x95+3x50/3E + 3x2,5ST+UEL		5DM2	12.7	70	73.9	8790	4275	0.206	0.3	0.32	319	13.59
3x120+3x70/3E + 3x2,5ST+UEL		5DM2	14.3	73.9	77.8	10137	5400	0.161	0.33	0.3	371	17.16
3x150+3x70/3E + 3x2,5ST+UEL		5DM2	16	78.9	82.8	11679	6750	0.129	0.36	0.29	428	21.45
3x185+3x95/3E + 3x2,5ST+UEL		5DM2	17.7	82.5	86.4	13095	8325	0.106	0.39	0.29	488	26.46

SUPROMONT (N)3GHSSYCY 18/30 kV

Number of cores x cross section	MLFB Number	Conductor diameter max. mm	Outer diameter min. mm	Outer diameter max. mm	Weight (approx.) kg/km	Permissible tensile force max. N	Conductor resistance at 20°C max. Ω/km	Nominal operating capacitance μF/km	Inductance nom. mH/km	Current carrying capacity (1) A	Short Circuit Current (conductor) kA
3x50+3x25/3E + 3x2,5ST+UEL	5DM2	9.1	67.4	71.4	7487	2250	0.386	0.2	0.37	215	7.15
3x70+3x35/3E + 3x2,5ST+UEL	5DM2	10.8	71.1	75.1	8549	3150	0.272	0.22	0.35	265	10.01
3x95+3x50/3E + 3x2,5ST+UEL	5DM2	12.7	76.5	80.4	10091	4275	0.206	0.25	0.34	319	13.59
3x120+3x70/3E + 3x2,5ST+UEL	5DM2	14.3	79.9	83.8	11268	5400	0.161	0.27	0.33	371	17.16
3x150+3x70/3E + 3x2,5ST+UEL	5DM2	16	84.4	89.3	12887	6750	0.129	0.29	0.31	428	21.45

(1) Nominal current carrying capacity for rubber cables laid on a surface, at 30°C ambient temperature (see also VDE 0298-4, Table 15). For derating-factors see tables in Technical Appendix

SUPROMONT (N)3GHSSHCH 6 kV – 20 kV

Halogen-free rubber insulated MV flexible cables for underground use



Application

As feeder cable for power supply of shiftable MV equipment, e.g. compressure resistant transformers, for underground mining applications as well as for tunnel sites.

Global data

Brand	SUPROMONT
Type designation	(N)3GHSSHCH
Standard	based on DIN VDE 0250 part 605
Certifications / Approvals	VDE certificate of conformity

Design features

Conductor	Bare electrolytic copper, finely stranded (class 5)
PE-Conductor	Individually laid-up concentrically around each main core
Insulation	PROTOLON, Basic material: EPR, Compound type: Special compound, better 3GI3
Electrical field control	Inner and outer semiconductive layer of semiconductive rubber, for 6kV outer semiconductive layer only
Core identification	Main cores: Natural color with black semiconductive layer, Control cores: Black with white digits
Core arrangement	Three main cores laid-up, one control core in each outer interstice
Inner sheath	Thermoplastic compound, type: HM4
Monitoring conductor	Conductive tape and overall concentric copper wire spinning
Intermediate sheath	Thermoplastic compound, type: HM4
Armouring	Braid of galvanized steel wires
Outer sheath	Thermoplastic compound, type: HM4, Color: Red

Electrical parameters

Rated voltage	3.6/6 kV	6/10 kV	8.7/15 kV	12/20 kV
Max. permissible operating voltage AC	4.2/7.2 kV	6,9/12 kV	10.4/18 kV	13.9/24 kV
Max. permissible operating voltage DC	5.4/10.8 kV	9/18 kV	13.5/27 kV	18/36 kV
AC test voltage	11 kV	17 kV	24 kV	29 kV
AC test voltage - control cores	2 kV	2 kV	2 kV	2 kV

Chemical parameters

Performance against fire	IEC 60332-1-2
Weather resistance	Unrestricted use indoors and in underground mines according to DIN VDE 0118, resistant to ozone and moisture

Thermal parameters

Max. operating temperature of the conductor	90 °C
Max. short circuit temperature of the conductor	250 °C
Ambient temperature for fixed installation	min -40 °C ; max +80 °C
Ambient temperature in fully flexible operation	min 5 °C ; max +80 °C

Mechanical parameters

Max. tensile load on the conductor	15 N/mm ²
Bending radii min.	Acc. to DIN VDE 0298 part 3

SUPROMONT (N)3GHSSHCH 3.6/6 kV

Number of cores x cross section	MLFB Number	Conductor diameter max. mm	Outer diameter min. mm	Outer diameter max. mm	Weight (approx.) kg/km	Permissible tensile force max. N	Conductor resistance at 20°C max. Ω/km	Nominal operating capacitance μF/km	Inductance nom. mH/km	Current carrying capacity (1) A	Short Circuit Current (conductor) kA
3x25+3x16/3E + 3x2,5ST+UEL	5DM2***	6.4	42.7	45.7	3178	1125	0.78	0.36	0.32	131	3.58
3x35+3x16/3E + 3x2,5ST+UEL	5DM2***	7.6	45.3	48.3	3696	1575	0.554	0.41	0.3	162	5.01
3x50+3x25/3E + 3x2,5ST+UEL	5DM2***	9.1	48.5	52.5	4508	2250	0.386	0.47	0.29	202	7.15
3x70+3x35/3E + 3x2,5ST+UEL	5DM2***	10.8	52.1	56.1	5437	3150	0.272	0.53	0.28	250	10.01
3x95+3x50/3E + 3x2,5ST+UEL	5DM2***	12.7	56.6	60.6	6638	4275	0.206	0.61	0.27	301	13.59
3x120+3x70/3E + 3x2,5ST+UEL	5DM2***	14.3	60.5	64.5	7953	5400	0.161	0.67	0.26	352	17.16
3x150+3x70/3E + 3x2,5ST+UEL	5DM2***	16.1	65	71	9150	6750	0.129	0.74	0.25	404	21.45

SUPROMONT (N)3GHSSHCH 6/10 kV

Number of cores x cross section	Part number	MLFB Number	Conductor diameter max. mm	Outer diameter min. mm	Outer diameter max. mm	Weight (approx.) kg/km	Permissible tensile force max. N	Conductor resistance at 20°C max. Ω/km	Nominal operating capacitance μF/km	Inductance nom. mH/km	Current carrying capacity (1) A	Short Circuit Current (conductor) kA
3x25+3x16/3E + 3x2,5ST+UEL		5DM2***	6.4	44.7	48.7	3586	1125	0.78	0.32	0.33	131	3.58
3x35+3x16/3E + 3x2,5ST+UEL	20148151	5DM2***	7.6	48.7	51.7	4020	1575	0.554	0.36	0.31	162	5.01
3x50+3x25/3E + 3x2,5ST+UEL	20067203	5DM2233	9.1	50.7	54.7	4840	2250	0.386	0.42	0.3	202	7.15
3x70+3x35/3E + 3x2,5ST+UEL		5DM2***	10.8	55.1	59.1	5680	3150	0.272	0.47	0.28	250	10.01
3x95+3x50/3E + 3x2,5ST+UEL	20067204	5DM2235	12.7	59.5	63.5	7090	4275	0.206	0.54	0.27	301	13.59
3x120+3x70/3E + 3x2,5ST+UEL	20275531	5DM2***	14.3	63.9	67.9	8460	5400	0.161	0.59	0.26	352	17.16

(1) Nominal current carrying capacity for rubber cables laid on a surface, at 30°C ambient temperature (see also VDE 0298-4, Table 15). For derating-factors see tables in Technical Appendix

SUPROMONT (N)3GHSSHCH 8.7/15 kV

Number of cores x cross section	Part number	MLFB Number	Conductor diameter max. mm	Outer diameter min. mm	Outer diameter max. mm	Weight (approx.) kg/km	Permissible tensile force max. N	Conductor resistance at 20°C max. Ω/km	Nominal operating capacitance μF/km	Inductance nom. mH/km	Current carrying capacity (1) A	Short Circuit Current (conductor) kA
3x25+3x16/3E + 3x2,5ST+UEL	20204583	5DM2***	6.4	49.1	53.1	3985	1125	0.78	0.26	0.35	139	3.58
3x35+3x16/3E + 3x2,5ST+UEL	20149013	5DM2***	7.6	52.1	56.1	4636	1575	0.554	0.29	0.33	172	5.01
3x50+3x25/3E + 3x2,5ST+UEL		5DM2***	9.1	53.9	57.9	5410	2250	0.386	0.33	0.31	215	7.15
3x70+3x35/3E + 3x2,5ST+UEL	20227836	5DM2***	10.8	57.6	61.6	6200	3150	0.272	0.38	0.3	265	10.01
3x95+3x95/3E + 3x2,5ST+UEL	20204584	5DM2***	12.7	63.6	67.6	7660	4275	0.206	0.43	0.29	319	13.59
3x120+3x70/3E + 3x2,5ST+UEL		5DM2***	14.3	67	71	8991	5400	0.161	0.47	0.28	371	17.16

SUPROMONT (N)3GHSSHCH 12/20 kV

Number of cores x cross section	Part number	MLFB Number	Conductor diameter max. mm	Outer diameter min. mm	Outer diameter max. mm	Weight (approx.) kg/km	Permissible tensile force max. N	Conductor resistance at 20°C max. Ω/km	Nominal operating capacitance μF/km	Inductance nom. mH/km	Current carrying capacity (1) A	Short Circuit Current (conductor) kA
3x25+3x25/3E + 3x2,5ST+UEL		5DM2***	6.4	52.6	56.6	4501	1125	0.78	0.22	0.37	139	3.58
3x35+3x16/3E + 3x2,5ST+UEL	20112422	5DM2242	7.6	53.6	57.6	4850	1575	0.554	0.25	0.35	172	5.01
3x50+3x25/3E + 3x2,5ST+UEL	20060690	5DM2243	9.1	56.8	60.8	5630	2250	0.385	0.28	0.33	215	7.15
3x70+3x35/3E + 3x2,5ST+UEL	20112425	5DM2244	10.8	61	65	6740	3150	0.272	0.32	0.31	265	10.01
3x95+3x50/3E + 3x2,5ST+UEL	20129798	5DM2245	12.7	66	70	8150	4275	0.206	0.36	0.3	319	13.59
3x120+3x70/3E + 3x2,5ST+UEL	20182384	5DM2***	14.3	70.5	74.5	9502	5400	0.161	0.39	0.29	371	17.16
3x150+3x70/3E + 3x2,5ST+UEL	20163741	5DM2***	16.5	76.5	80.5	10900	6750	0.129	0.44	0.28	428	21.45

(1) Nominal current carrying capacity for rubber cables laid on a surface, at 30°C ambient temperature (see also VDE 0298-4, Table 15). For derating-factors see tables in Technical Appendix

PROTOMONT(MT) (N)SHOEU 1 kV

Low Voltage light and flexible rubber cable



Application

Rubber-sheathed flexible cables for mining application, suitable for laying alongside conveyor belts (also for shiftable units), on material handling equipment and for tunneling sites, under heavy mechanical stress, e.g. in cable suspension fittings and as connection between upper and lower cars. The cables can be used indoors as well as outdoors, in explosion-hazard areas, in industry and in agriculture.

The cables are water resistant and also suitable for connection of submersible pump units.

In other respects the specifications of DIN VDE 0298 part 3 applies.

Global data

Brand	PROTOMONT(MT)
Type designation	(N)SHOEU
Standard	Based on DIN VDE 0250 part 812
Certifications / Approvals	VDE certificate with factory surveillance

Notes on installation

Notes on installation	max. depth 500m
-----------------------	-----------------

Design features

Conductor	Bare electrolytic copper, finely stranded (class 5)
Insulation	PROTOLON, Basic material: EPR, Compound type: Special compound better 3GI3
Core identification	Light gray with black digits
Screen	In case of concentric screen (KON types only): closed layer of copper wire spinning over core assembly
Inner sheath	Basic material: EPR, Compound type: Special compound
Outer sheath	Basic material: Chlorinated rubber, Compound type: Special compound, 5GM5 Colour: yellow

Electrical parameters

Rated voltage	0.6/1 kV (600/1000V)
Max. permissible operating voltage AC	0.7/1.2 kV
Max. permissible operating voltage DC	0.9/1.8 kV
AC test voltage - main cores	3,5 kV (5 Min.)
AC test voltage - control cores	2 kV

Chemical parameters

Performance against fire	IEC 60332-1-2
Resistance to oil	IEC 60811-404
Weather resistance	Unrestricted use outdoors and indoors, resistant to ozone and moisture
Water resistance	EN 50525-2-21

Thermal parameters

Max. operating temperature of the conductor	90 °C
Max. short circuit temperature of the conductor	250 °C
Max. permissible water temperature	40 °C (At higher water temperatures, a shortened cable service life is to be expected)
Ambient temperature for fixed installation	min -40 °C ; max +80 °C
Ambient temperature in fully flexible operation	min -25 °C ; max +60 °C

Mechanical parameters

Max. tensile load on the conductor	15 N/mm ²
Torsional stress +/-	100 °/m
Bending radii min.	Acc. to DIN VDE 0298 part 3
Travel speed	Max. speed on rewinding with drum car: 60 m/min

PROTOMONT(MT) (N)SHOEU 0.6/1 kV

Number of cores x cross section	Part number	MLFB Number	Conductor diameter max. mm	Outer diameter min. mm	Outer diameter max. mm	Weight (approx.) kg/km	Permissible tensile force max. N	Conductor resistance at 20°C max. Ω/km	Nominal operating capacitance μF/km	Inductance nom. mH/km	Current carrying capacity (1) A	Short Circuit Current (conductor) kA
PROTOMONT(MT) (N)SHOEU-O												
1x16	20265363	5DL4***	5.2	9.5	11.1	230	240	1.21	0.44	0.26	99	2.29
1x25	20265364	5DL4***	6.4	11	12.6	335	375	0.78	0.45	0.26	131	3.58
1x35	20265365	5DL4***	7.5	12.3	13.9	435	525	0.554	0.52	0.25	162	5.01
1x50	20265366	5DL4***	9	14.5	16.5	615	750	0.386	0.54	0.25	202	7.15
1x70	20265367	5DL4***	11.1	16.4	18.4	830	1050	0.272	0.61	0.24	250	10.01
1x95	20265369	5DL4***	12.8	18.5	20.5	1060	1425	0.206	0.64	0.24	301	13.59
1x120	20265370	5DL4***	14.5	20.4	22.4	1300	1800	0.161	0.72	0.23	352	17.16
1x150	20265372	5DL4***	16.5	22.8	24.8	1600	2250	0.129	0.72	0.23	404	21.45
1x185	20265373	5DL4***	17.9	24.7	27.7	2020	2775	0.106	0.71	0.23	461	26.46
1x240	20265374	5DL4***	21.2	27.6	30.6	2548	3600	0.08	0.76	0.23	540	34.32
1x300	20265377	5DL4***	23.6	31.6	34.6	3200	4500	0.0641	0.78	0.23	620	42.9
PROTOMONT(MT) (N)SHOEU-O												
2x1,5	20265378	5DL4***	1.6	9.8	11.4	150	45	13.3	0.21	0.33	23	0.18
2x2,5	20265379	5DL4***	2	10.7	12.3	185	75	7.98	0.24	0.32	30	0.31
2x4		5DL4	2.4	11.9	13.5	220	120	4.95	0.27	0.3	41	0.57
PROTOMONT(MT) (N)SHOEU-O												
3x2,5	20265395	5DL4***	2	11.1	12.7	210	113	7.98	0.24	0.32	30	0.31
3x4	20265396	5DL4***	2.4	12.1	13.7	271	180	4.95	0.27	0.3	41	0.57
3x6	20265397	5DL4***	2.9	13.2	14.8	350	270	3.3	0.32	0.29	53	0.86
3x10	20265398	5DL4***	3.9	16.1	18.1	505	450	1.91	0.34	0.28	74	1.43
3x16	20265399	5DL4***	5.2	19	21	775	720	1.21	0.44	0.26	99	2.29
3x25	20265400	5DL4***	6.4	22.9	24.9	1160	1125	0.78	0.45	0.26	131	3.58
3x35	20265401	5DL4***	7.5	24.9	27.9	1550	1575	0.554	0.52	0.25	162	5.01
3x50	20265402	5DL4***	9	29.4	32.4	2180	2250	0.386	0.54	0.25	202	7.15
3x70	20265403	5DL4***	11.1	34.8	37.8	3020	3150	0.272	0.61	0.24	250	10.01
3x95	20265405	5DL4***	12.8	40.9	43.9	3810	4275	0.206	0.64	0.24	301	13.59
3x120	20265406	5DL4***	14.4	44.7	47.7	4970	5400	0.161	0.72	0.23	352	17.16
3x150	20265407	5DL4***	16.1	50	54	6290	6750	0.129	0.72	0.23	404	21.45
3x185	20265408	5DL4***	17.9	54.6	58.6	7470	8325	0.106	0.95	0.22	461	26.46
PROTOMONT(MT) (N)SHOEU-J												
3x1,5	20265409	5DL4***	1.6	10.2	11.8	170	68	13.3	0.21	0.33	23	0.18
3x2,5	20265410	5DL4***	2	11.1	12.7	220	113	7.98	0.24	0.32	30	0.31
3x4	20265411	5DL4***	2.4	12.1	13.7	290	180	4.95	0.27	0.31	41	0.57
3x6	20265412	5DL4***	2.9	13.2	14.8	360	270	3.3	0.32	0.29	53	0.86
PROTOMONT(MT) (N)SHOEU-J												
4x1,5	20265413	5DL4***	1.6	11	12.6	204	90	13.3	0.21	0.33	23	0.18
4x2,5	20265414	5DL4***	2	12	13.6	270	150	7.98	0.24	0.32	30	0.31
4x4	20265415	5DL4***	2.4	13	14.6	338	240	4.95	0.27	0.3	41	0.57
4x6	20265416	5DL4***	2.9	14.9	16.9	450	360	3.3	0.32	0.29	53	0.86
4x10	20265417	5DL4***	3.9	17.4	19.4	690	600	1.91	0.34	0.28	74	1.43
4x16	20265418	5DL4610	5.2	21	23	980	960	1.21	0.44	0.26	99	2.29
4x25	20265419	5DL4***	6.4	24.5	27.5	1490	1500	0.78	0.45	0.26	131	3.58
4x35	20265420	5DL4***	7.5	28.4	31.4	1870	2100	0.554	0.52	0.25	162	5.01

(1) Nominal current carrying capacity for rubber cables laid on a surface, at 30°C ambient temperature (see also VDE 0298-4, Table 15). For derating-factors see tables in Technical Appendix
Halogen-free version with 5GM3 outer sheath available on request

Continued from previous page.

PROTOMONT(MT) (N)SHOEU 0.6/1 kV

Number of cores x cross section	Part number	MLFB Number	Conductor diameter max. mm	Outer diameter min. mm	Outer diameter max. mm	Weight (approx.) kg/km	Permissible tensile force max. N	Conductor resistance at 20°C max. Ω/km	Nominal operating capacitance μF/km	Inductance nom. mH/km	Current carrying capacity (1) A	Short Circuit Current (conductor) kA
4x50	20265421	5DL4***	9	33.6	36.6	2570	3000	0.386	0.54	0.25	202	7.15
4x70	20265423	5DL4***	10.6	39.5	42.5	3920	4200	0.272	0.61	0.24	250	10.01
4x95	20265424	5DL4***	12.8	44.8	47.8	5040	5700	0.206	0.64	0.24	301	13.59
4x120	20265425	5DL4613	14.4	49.8	53.8	6200	7200	0.161	0.72	0.23	352	17.16
4x150		5DL4	16.1	54.9	58.9	7578	9000	0.129	0.72	0.23	404	21.45
PROTOMONT(MT) (N)SHOEU-J												
3x50+3x25/3	20278765	5DL4***	9	29.4	32.4	2350	2250	0.386	0.54	0.25	202	7.15
3x70+3x35/3	20268926	5DL4614	10.6	35.1	38.1	3220	3150	0.272	0.61	0.24	250	10.01
3x95/50	20220195	5DL4***	12.1	44.8	47.8	4400	4275	0.206	0.6	0.24	301	13.59
3x95+3x50/3	20268927	5DL4615	12.8	40.7	43.7	4300	4275	0.206	0.64	0.24	301	13.59
3x120+3x70/3	20268929	5DL4616	14.4	44.5	47.5	5370	5400	0.161	0.72	0.23	352	17.16
3x150+3x70/3	20278766	5DL4***	16.5	51.6	55.6	6950	6750	0.129	0.72	0.23	404	21.45
3x185+3x95/3	20278767	5DL4***	17.9	54.5	58.5	8150	8325	0.106	0.71	0.23	461	26.46
3x240+3x120/3	20278768	5DL4***	20.6	62.2	66.2	10700	10800	0.08	0.76	0.23	540	34.32
3x300+3x150/3	20278769	5DL4***	23.4	70.3	74.3	13300	13500	0.064	0.78	0.23	620	42.9
PROTOMONT(MT) (N)SHOEU-J												
5x1,5	20278770	5DL4***	1.6	11.9	13.5	240	113	13.3	0.21	0.33	23	0.18
5x2,5	20278771	5DL4***	2	12.9	14.5	310	188	7.98	0.24	0.32	30	0.31
5x4	20268918	5DL4605	2.4	14.7	16.7	420	300	4.95	0.27	0.3	41	0.57
5x6	20268919	5DL4606	2.9	16.1	18.1	530	450	3.3	0.32	0.29	53	0.86
5x10	20268772	5DL4	3.9	19	21	795	750	1.91	0.34	0.28	74	1.43
5x16	20268920	5DL4607	5.2	22.8	24.8	1180	1200	1.21	0.44	0.26	99	2.29
5x25	20278773	5DL4***	6.4	28	31	1880	1875	0.78	0.45	0.26	131	3.58
5x35	20278774	5DL4***	7.5	34.5	37.5	2650	2625	0.554	0.46	0.25	162	5.01
PROTOMONT(MT) (N)SHOEU-O Control cables												
12x4	20278807	5DL4***	2.4	20.8	22.8	870	720	4.95	0.27	0.3	41	0.57
12x6	20278808	5DL4***	2.9	23.4	26.4	1150	1080	3.3	0.32	0.29	53	0.86
PROTOMONT(MT) (N)SHOEU-J Control cables												
7x1,5	20278776	5DL4***	1.6	12.9	14.5	300	158	13.3	0.21	0.33	23	0.18
8x1,5		5DL4	1.6	13.8	15.4	325	180	13.3	0.21	0.33	23	0.18
10x1,5		5DL4	1.6	15.5	17.5	400	225	13.3	0.21	0.33	23	0.18
12x1,5	20278777	5DL4***	1.6	15.8	17.8	500	270	13.3	0.21	0.33	23	0.18
14x1,5		5DL4	1.6	16.8	18.8	495	315	13.3	0.21	0.33	23	0.18
18x1,5	20278778	5DL4***	1.6	18.5	20.5	610	405	13.3	0.21	0.33	23	0.18
19x1,5	20278779	5DL4***	1.6	18.9	20.9	650	428	13.3	0.21	0.33	23	0.18
24x1,5	20278780	5DL4***	1.6	20	22	800	540	13.3	0.21	0.33	23	0.18
7x2,5	20278801	5DL4***	2	14.9	16.9	450	263	7.98	0.24	0.32	30	0.31
8x2,5	20278802	5DL4***	2	15.8	17.8	480	300	7.98	0.24	0.32	30	0.31
10x2,5		5DL4	2	16.4	18.4	500	375	7.98	0.24	0.32	30	0.31
12x2,5	20278803	5DL4***	2	18	20	600	450	7.98	0.24	0.32	30	0.31
15x2,5	20278804	5DL4***	2	20.7	22.7	780	563	7.98	0.24	0.32	30	0.31
18x2,5	20278805	5DL4***	2	21.2	23.2	850	675	7.98	0.24	0.32	30	0.31
19x2,5		5DL4	2	22.3	24.3	900	713	7.98	0.24	0.32	30	0.31
24x2,5	20278806	5DL4***	2	22.8	24.8	1070	900	7.98	0.24	0.32	30	0.31

(1) Nominal current carrying capacity for rubber cables laid on a surface, at 30°C ambient temperature (see also VDE 0298-4, Table 15). For derating-factors see tables in Technical Appendix
Halogen-free version with 5GM3 outer sheath available on request

Continued from previous page.

PROTOMONT(MT) (N)SHOEU 0.6/1 kV

Number of cores x cross section	Part number	MLFB Number	Conductor diameter max. mm	Outer diameter min. mm	Outer diameter max. mm	Weight (approx.) kg/km	Permissible tensile force max. N	Conductor resistance at 20°C max. Ω/km	Nominal operating capacitance μF/km	Inductance nom. mH/km	Current carrying capacity (1) A	Short Circuit Current (conductor) kA
37x2,5		5DL4	2	29	31	1600	1388	7.98	0.24	0.32	30	0.31
PROTOMONT(MT) (N)SHOEU-J... KON Control cables												
3x0,75/0,75KON			1.1	6.6	7.6	96	34	26	0.27	0.29	8	0.11
18x1,5/1,5KON			1.6	22	24	720	405	13.3	0.21	0.33	23	0.18
4x1,5/1,5KON			1.6	13	14.6	280	90	13.3	0.19	0.35	23	0.18
7x1,5/4KON			1.6	15.5	17.5	360	158	13.3	0.21	0.33	23	0.18
9x1,5/4KON			1.6	17.5	19.5	430	203	13.3	0.21	0.33	23	0.18
12x1,5/4KON			1.6	18	20	517	270	13.3	0.21	0.33	23	0.18
15x1,5/4KON			1.6	21	23	600	338	13.3	0.21	0.33	23	0.18
19x1,5/4KON			1.6	22	24	700	428	13.3	0.21	0.33	23	0.18
7x2,5/2,5KON			2	14	15.6	418	263	7.98	0.24	0.32	30	0.31
12x2,5/2,5KON			2	16	18	630	450	7.98	0.24	0.32	30	0.31

(1) Nominal current carrying capacity for rubber cables laid on a surface, at 30°C ambient temperature (see also VDE 0298-4, Table 15). For derating-factors see tables in Technical Appendix
Halogen-free version with 5GM3 outer sheath available on request

PROTOMONT NSSHOEU .../3E 1 kV

Rubber-sheathed flexible cable with copper core shield

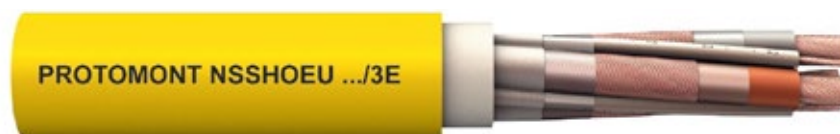

Application

The cables are suitable for fixed installation and flexible operation as power supply cables to motors, distribution boards, pumps, drilling rigs, etc., for underground mining applications, for tunnel building applications, for open-cast mining applications, for use in quarries and similar applications. Permitted for applications according to DIN VDE 0118.

Global data

Brand	PROTOMONT
Type designation	NSSHOEU
Standard	DIN VDE 0250-812
Certifications / Approvals	MA – China (special design) MSHA P-189-3 BAS Bosnia-Herzegovina TR-Certificate EAC-Certificate

Design features

Conductor	Bare electrolytic copper, finely stranded (class 5)
PE-Conductor	Individual-concentric or overall concentric spinning of untinned copper wires
Insulation	PROTOLON, Basic material: EPR, Compound type: 3GI3
Core identification	Up to 5 cores colored, Core colors: Blue, Brown, Black, Grey, Black
Core arrangement	Three, four of five cores laid-up
Inner sheath	Vulcanized rubber inner sheath, Basic material: EPR, Compound type: GM1B
Outer sheath	PROTOFIRM, Basic material: Chlorinated rubber, Compound type: 5GM5, Color: Yellow

Electrical parameters

Rated voltage	$U_0/U = 0,6/1$ kV, also permitted for $U_0/U = 640/1140$ V
Max. permissible operating voltage AC	0.7/1.2 kV
Max. permissible operating voltage DC	0.9/1.8 kV
AC test voltage	3 kV
AC test voltage - control cores	2 kV

Chemical parameters

Performance against fire	IEC 60332-1-2
Resistance to oil	IEC 60811-404
Weather resistance	Unrestricted use outdoors and indoors, resistant to ozone and moisture
Water resistance	DIN EN 50525-2-21

Thermal parameters

Max. operating temperature of the conductor	90 °C
Max. short circuit temperature of the conductor	250 °C
Ambient temperature for fixed installation	min -40 °C ; max +80 °C
Ambient temperature in fully flexible operation	min -25 °C ; max +60 °C

Mechanical parameters

Max. tensile load on the conductor	15 N/mm ²
Bending radii min.	Acc. to DIN VDE 0298 part 3

PROTOMONT NSSHOEU .../3E 0,6/1 kV

Number of cores x cross section	Part number	MLFB Number	Conductor diameter max. mm	Outer diameter min. mm	Outer diameter max. mm	Weight (approx.) kg/km	Permissible tensile force max. N	Conductor resistance at 20°C max. Ω/km	Nominal operating capacitance μF/km	Inductance nom. mH/km	Current carrying capacity (1) A	Short Circuit Current (conductor) kA
PROTOMONT NSSHOEU.../3E												
3x1,5+3x1,5/3E	20005094	5DM4604	1.6	12.5	14.1	280	68	13.3	0.21	0.33	23	0.22
3x2,5+3x2,5/3E	20005095	5DM4605	2	13.6	15.2	340	113	7.98	0.24	0.32	30	0.36
3x4+3x4/3E	20039860	5DM4606	2.4	16.1	18.1	480	180	4.95	0.26	0.31	41	0.57
3x6+3x6/3E	20005096	5DM4607	2.9	17.4	19.4	570	270	3.3	0.3	0.29	53	0.86
3x10+3x10/3E	20005097	5DM4610	4	20.3	22.3	820	450	1.91	0.33	0.28	74	1.43
3x16+3x16/3E	20005098	5DM4612	5	23.9	25.9	1180	720	1.21	0.4	0.27	99	2.29
3x25+3x16/3E	20040501	5DM4613	6.4	27.7	30.7	1640	1125	0.78	0.42	0.26	131	3.58
3x35+3x16/3E	20039858	5DM4614	6.5	30.1	33.1	1990	1575	0.554	0.49	0.25	162	5.01
3x50+3x25/3E	20008752	5DM4615	9	35.9	38.9	2840	2250	0.386	0.51	0.25	202	7.15
3x70+3x35/3E	20007207	5DM4616	10.7	40.6	43.6	3780	3150	0.272	0.6	0.24	250	10.01
3x95+3x50/3E	20005099	5DM4617	12.3	45.5	48.5	4880	4275	0.206	0.61	0.24	301	13.59
3x120+3x70/3E	20015058	5DM4618	14.3	51.9	55.9	6340	5400	0.161	0.7	0.23	352	17.16
3x150+3x70/3E	20006978	5DM4620	16	56.2	60.2	7500	6750	0.129	0.7	0.23	404	21.45
3x185+3x95/3E	20006979	5DM4627	17.7	62.8	66.8	9300	8325	0.106	0.7	0.23	461	26.46
3x240+3x120/3E	20006980	5DM4628	20.3	69.6	73.6	11790	10800	0.08	0.71	0.22	540	34.32
PROTOMONT NSSHOEU.../3E+ST												
3x2,5 + 3x2,5/3E + 3x1,5ST	20005100	5DM4624	2	17.1	19.1	510	113	7.98	0.24	0.32	30	0.36
3x4+3x4/3E + 3x1,5ST	20025110	5DM4626	2.4	17.8	19.8	580	180	4.95	0.26	0.31	41	0.57
3x6+3x6/3E + 3x1,5ST	20005101	5DM4630	2.9	18.4	20.4	640	270	3.3	0.3	0.29	53	0.86
3x10 + 3x10/3E + 3x2,5ST	20005102	5DM4631	4	22.1	24.1	960	450	1.91	0.33	0.28	74	1.43
3x16 + 3x16/3E + 3x2,5ST	20005103	5DM4632	5	23.9	25.9	1250	720	1.21	0.4	0.27	99	2.29
3x25 + 3x16/3E + 3x2,5ST	20005104	5DM4633	6.4	27.7	30.7	1690	1125	0.78	0.42	0.26	131	3.58
3x35 + 3x16/3E + 3x2,5ST	20005105	5DM4634	7.5	30.1	33.1	2040	1575	0.554	0.49	0.25	162	5.01
3x50 + 3x25/3E + 3x2,5ST	20005106	5DM4635	9	35.9	38.9	2890	2250	0.386	0.51	0.25	202	7.15
3x70 + 3x35/3E + 3x2,5ST	20005107	5DM4636	10.7	40.6	43.6	3870	3150	0.272	0.6	0.24	250	10.01
3x95 + 3x50/3E + 3x2,5ST	20005108	5DM4637	12.3	45.5	48.5	4970	4275	0.206	0.61	0.24	301	13.59
3x120 + 3x70/3E + 3x2,5ST	20005109	5DM4638	14.3	51.9	55.9	6430	5400	0.161	0.69	0.23	352	17.16
3x150 + 3x70/3E + 3x2,5ST	20060692	5DM4642	16	56.2	60.2	7330	6750	0.129	0.7	0.23	404	21.45
3x185 + 3x95/3E + 3x2,5ST	20007785	5DM4644	17.7	62.8	66.8	9390	8325	0.106	0.7	0.23	461	26.46
3x240 + 3x120/3E + 3x2,5ST	20100480	5DM4651	20.3	69.6	73.6	11810	10800	0.08	0.71	0.22	540	34.32
PROTOMONT NSSHOEU.../KON												
3x1,5/1,5KON	20161197	5DL2404	1.6	12.4	14	270	68	13.7	0.21	0.33	23	0.22
3x2,5/2,5KON	20004908	5DL2405	1.9	13.7	15.3	350	113	8.21	0.24	0.32	30	0.36
3x4/4KON			2.4	16.1	18.1	450	180	5.09	0.27	0.3	41	0.57
4x6/6KON	20198030	5DL2507	2.9	18.8	20.8	645	360	3.39	0.32	0.29	53	0.86
4x10/10KON	20168272	5DL2508	4.8	23.1	25.1	1010	600	1.95	0.34	0.28	74	1.43
4x16/16KON			5.7	27.1	30.1	1520	960	1.24	0.44	0.26	99	2.29
5x2,5/2,5KON	20004909	5DL2605	1.9	16.4	18.4	490	188	8.21	0.24	0.32	30	0.36
5x4/4KON	20004910	5DL2606	2.4	18.2	20.2	620	300	5.09	0.27	0.3	41	0.57
5x6/6KON	20024743	5DL2607	2.9	21.3	23.3	850	450	3.39	0.32	0.29	53	0.86

(1) Nominal current carrying capacity for rubber cables laid on a surface, at 30°C ambient temperature (see also VDE 0298-4, Table 15). For derating-factors see tables in Technical Appendix

PROTOMONT EMV-FC (N)SSHCOEU 1 kV

Cables for Variable Frequency Converter



Application

The cables are suitable for fixed installation and flexible operation as motor power supply cables for frequency converter controlled drives in the mining industry, on construction sites and similar applications, with heavy mechanical stresses. For laying on material handling equipment (even with continuous movement such as in cable booms or as connection between upper and lower car). Can be applied in water up to 40°C, approximately up to 10 m depth.

Global data

Brand	PROTOMONT EMV-FC
Type designation	(N)SSHCOEU
Standard	Based on DIN VDE 0250 part 812
Certifications / Approvals	MSHA P-189-3 EAC Certificate

Design features

Conductor	Finely stranded copper conductor, tinned (class 5) according to DIN EN 60228
Insulation	PROTOLON, Basic material: EPR, Compound type: 3GI3
Core identification	Natural coloring with black figures
Core arrangement	Three power cores laid up with the protective earth conductors split into three in the outer interstices
Screen	EMC optimized, concentric braid of tinned copper wires
Inner sheath	Vulcanized rubber compound, Basic material: EPR, Compound type: GM1B
Outer sheath	PROTOFIRM, synthetic elastomer compound e.g. CR, Compound type: 5GM5, Color: Yellow

Electrical parameters

Rated voltage	U ₀ /U = 0,6/1 kV, also permitted for U ₀ /U = 640/1140V
Max. permissible operating voltage AC	0.7/1.2 kV
Max. permissible operating voltage DC	0.9/1.8 kV
AC test voltage - main cores	5 kV (5 Min.)

Chemical parameters

Performance against fire	IEC 60332-1-2
Resistance to oil	IEC 60811-404
Weather resistance	Unrestricted use outdoors and indoors, resistant to ozone and moisture

Thermal parameters

Max. operating temperature of the conductor	90 °C
Max. short circuit temperature of the conductor	250 °C
Ambient temperature for fixed installation	min -40 °C ; max +80 °C
Ambient temperature in fully flexible operation	min -25 °C ; max +60 °C

Mechanical parameters

Max. tensile load on the conductor	15 N/mm ²
Torsional stress +/-	25 °/m
Bending radii min.	Acc. to DIN VDE 0298 part 3

PROTOMONT EMV-FC (N)SSHCOEU 0.6/1 kV

Number of cores x cross section	Part number	MLFB Number	Conductor diameter max. mm	Outer diameter min. mm	Outer diameter max. mm	Weight (approx.) kg/km	Permissible tensile force max. N	Conductor resistance at 20°C max. Ω/km	Nominal operating capacitance μF/km	Inductance nom. mH/km	Current carrying capacity (1) A	Short Circuit Current (conductor) kA
3x16+3x2,5	20004904	5DL2108	5.4	24.4	27.4	1190	720	1.24	0.42	0.26	99	2.29
3x25+3x4	20016716	5DL2107	6.3	28.2	31.2	1680	1125	0.795	0.42	0.26	131	3.58
3x35+3x16/3	20004903	5DL2106	7.5	30.5	33.5	2000	1575	0.565	0.49	0.25	162	5.01
3x50+3x25/3	20004902	5DL2105	8.9	36	39	2820	2250	0.393	0.51	0.25	202	7.15
3x70+3x35/3	20004901	5DL2104	10.6	41.2	44.2	3800	3150	0.277	0.59	0.24	250	10.01
3x95+3x50/3	20004900	5DL2103	12.1	45.7	48.7	4760	4275	0.21	0.6	0.24	301	13.59
3x120+3x70/3	20001453	5DL2100	14.1	48.7	52.7	5890	5400	0.164	0.69	0.23	352	17.16
3x150+3x70/3	20004899	5DL2101	16	55.7	59.7	7230	6750	0.132	0.7	0.23	404	21.45
3x185+3x95/3	20004905	5DL2109	17.8	60.4	64.4	8640	8325	0.108	0.71	0.23	461	26.46
3x240+3x120/3	20008903	5DL2102	20.2	68.2	72.2	11100	10800	0.0817	0.73	0.23	540	34.32

(1) Nominal current carrying capacity for rubber cables laid on a surface, at 30°C ambient temperature (see also VDE 0298-4, Table 15). For derating-factors see tables in Technical Appendix



Tunnelling

Index

Product overview	138
TBM REELING	140
PROTOMONT TBM (N)TSCGECW0EU 10 kV – 30 kV	140
PROTOMONT TBM (N)TSCGECWHX0EU 10 kV – 20 kV	144
TENAX-HTT (N)TSCGEW0EU 10 kV – 30 kV	146
CABLES FOR SEMI-FIXED INSTALLATION	150
PROTOMONT NTSKCGECW0EU – Festoon 3.6/6 kV	150
SUPROMONT (N)3GHSSYCY 6 kV – 30 kV	152
SUPROMONT (N)3GHSSHCH 6 kV – 20 kV	156
PROTOMONT(MT) (N)SH0EU 1 kV	160
PROTOMONT NSSH0EU .../3E 1 kV	164
PROTOMONT EMV-FC (N)SSHCOEU 1 kV	166



Product overview

TBM REELING			
	PROTOMONT TBM (N)TSCGECW0EU	PROTOMONT TBM (N)TSCGECWHX0EU	TENAX-HTT
Application	Reeling	Reeling	Reeling
Cable design	Based on VDE, double screen technology	Based on VDE, double screen technology, halogen-free	Acc. to VDE, single screen technology
Travel speed max. m/min	30	30	30
Permissible tensile force (N/mm ²)	15	15	15
Stability against torsion (°/m)	+/- 25	+/- 25	+/- 100
Sheath quality	5GM5	5GM3	5GM5
Sheath abrasion against surface	+++	++	+++
Reversed bending stability	+++	+++	+++
Temperature range in fully flexible operation (°C)	-20 to +60	-20 to +60	-20 to +60
Cold removable semicon screens	+++	+++	+++
Approvals	Fire certificate, Gost -R/-K/-B	Fire certificate, Gost -R/-K/-B	Fire certificate, Gost -R/-K/-B

CABLES FOR SEMI-FIXED INSTALLATION			
	PROTOMONT Festoon	SUPROMONT (N)3GHSSYCY	SUPROMONT (N)3GHSSHCH
Application	MV semi-fixed	MV semi-fixed	MV semi-fixed
Cable design	Acc. to VDE	Based on VDE	Based on VDE
Special design features	Double screen technology	Double screen technology	Double screen technology, halogen-free
Permissible tensile force (N/mm ²)	15	15	15
Sheath quality	5GM5	PVC YM5	HM4
Reversed bending stability	+++	++	++
Temperature range in fully flexible operation (°C)	-25 to +60	+5 to +60	+5 to +60
Approvals	MA - China, WUG - Poland, BAS-Certificate, Fire certificate, Gost -R/-B/-K	VDE certificate of conformity	VDE certificate of conformity

	PROTOMONT(MT) (N)SH0EU	PROTOMONT NSSH0EU../3E	PROTOMONT EMV-FC
Application	LV semi-fixed	LV semi-fixed	LV frequency converter cable
Cable design	Based on VDE	Acc. to VDE	Acc. to VDE
Special design features		Concentric core screens	Excellent EMC properties
Permissible tensile force (N/mm ²)	15	15	15
Stability against torsion (°/m)		+/- 25	+/- 25
Sheath quality	5GM5	5GM5	5GM5
Reversed bending stability	++	+++	++
Temperature range in fully flexible operation (°C)	-25 to +60	-25 to +60	-25 to +60 -45 to +60
Approvals	VDE certificate with factory surveillance	MA-China, MSHA P-189-3, BAS-certificate, EAC certificate	MSHA P-189-3, EAC certificate



Abgang von Trasse 5
200 m Bohrwagenleitung

Abgang K111 25m
Bohrwagenleitung

1000V

Abgang K111 25m
Bohrwagenleitung

Abgang K211
60 m Bohrwagenleitung
K313

1112 Leitung für
Bohrwagenstation
K211
K211 Frei
K313
K221 Frei

PROTOMONT TBM (N)TSCGECW0EU 10 kV – 30 kV

MV reeling cables for TBMs



Application

The cables are suitable for use as reeling power supply cables for tunnel boring machines (TBM) in underground mines and for tunnel construction sites.

Global data

Brand	PROTOMONT TBM
Type designation	(N)TSCGECW0EU
Standard	Based on DIN VDE 0250-813
Certifications / Approvals	Fire Certificate of Russian Federation GOST -R/-K/-B

Design features

Conductor	Finely stranded copper conductor, tinned (class 5)
PE-Conductor	Single concentric copper/textile mixed braid over every core
Insulation	PROTOLON, Basic material: EPR, Compound type: special compound
Electrical field control	Inner and outer protective layer of semiconductive rubber compound
Core identification	Main cores: Natural coloring with black semiconductive rubber, Control cores: Black
Core arrangement	Three main conductors laid-up with three control cores in the outer interstice
Inner sheath	Vulcanized rubber inner sheath, Basic material: EPR, Compound type: GM1B
Monitoring conductor	Overall concentric lay of copper wire spinning
Outer sheath	PROTOFIRM, synthetic elastomer compound e.g. CR, Compound type: 5GM5, Color: Red

Electrical parameters

Rated voltage	6/10 kV	8.7/15 kV	12/20 kV	14/25 kV	18/30 kV
Max. permissible operating voltage AC	6,9/12 kV	10.4/18 kV	13.9/24 kV	17.3/30 kV	20.8/36 kV
Max. permissible operating voltage DC	9/18 kV	13.5/27 kV	18/36 kV	22.5/45 kV	27/54 kV
AC test voltage	17 kV	24 kV	29 kV	36 kV	43 kV
AC test voltage - control cores	2 kV	2 kV	2 kV	2 kV	2 kV

Chemical parameters

Performance against fire	IEC 60332-1-2
Resistance to oil	IEC 60811-404
Weather resistance	Unrestricted use outdoors and indoors, resistant to ozone and moisture

Thermal parameters

Max. operating temperature of the conductor	90 °C
Max. short circuit temperature of the conductor	250 °C
Ambient temperature for fixed installation	min -40 °C ; max +80 °C
Ambient temperature in fully flexible operation	min -20 °C ; max +60 °C

Mechanical parameters

Max. tensile load	For reeling application: max. 15 N/mm ² For TBM application: max. 30 N/mm ²
Torsional stress +/-	25 °/m
Bending radii min.	Acc. to DIN VDE 0298 part 3
Min. distance with S-type directional changes	20 x D
Travel speed	max. 30 m/min

PROTOMONT TBM (N)TSCGECW0EU 6/10 kV

Number of cores x cross section	Part number	MLFB Number	Conductor diameter max. mm	Outer diameter min. mm	Outer diameter max. mm	Weight (approx.) kg/km	Permissible tensile force max. N	Conductor resistance at 20°C max. Ω/km	Nominal operating capacitance μF/km	Inductance nom. mH/km	Current carrying capacity (1) A	Short Circuit Current (conductor) kA
3x25 + 3x16/3E + 3x2,5ST + 6UELKON	20005060	5DM1328	6.4	43	46	3030	1125	0.795	0.31	0.33	131	3.58
3x35 + 3x25/3E + 3x2,5ST + 6UELKON	20005061	5DM1331	7.6	45.7	48.7	3600	1575	0.565	0.35	0.32	162	5.01
3x50 + 3x25/3E + 3x2,5ST + 6UELKON	20008789	5DM1332	9.1	47.9	51.9	4190	2250	0.393	0.4	0.3	202	7.15
3x70 + 3x35/3E + 3x2,5ST + 6UELKON	20008855	5DM1333	10.9	54.6	58.6	5550	3150	0.277	0.46	0.29	250	10.01
3x95 + 3x50/3E + 3x2,5ST + 6UELKON	20008403	5DM1334	12.6	58.3	62.3	6630	4275	0.21	0.52	0.27	301	13.59
3x120 + 3x70/3E + 3x2,5ST + 6UELKON	20160785	5DM1355	14.2	62.1	66.1	7840	5400	0.164	0.57	0.27	352	17.16
3x150 + 3x70/3E + 3x2,5ST + 6UELKON	20173765	5DM1***	15.8	66.6	70.6	8490	6750	0.129	0.63	0.26	404	21.45
3x185 + 3x95/3E + 3x2,5ST + 6UELKON	20215162	5DM1369	17.8	73.1	77.1	10860	8325	0.106	0.64	0.26	461	26.46
3x240 + 3x120/3E + 3x2,5ST + 6UELKON	20215163	5DM1370	20.4	80.7	84.7	13820	10800	0.0801	0.64	0.25	540	34.32

PROTOMONT TBM (N)TSCGECW0EU 8.7/15 kV

Number of cores x cross section	Part number	MLFB Number	Conductor diameter max. mm	Outer diameter min. mm	Outer diameter max. mm	Weight (approx.) kg/km	Permissible tensile force max. N	Conductor resistance at 20°C max. Ω/km	Nominal operating capacitance μF/km	Inductance nom. mH/km	Current carrying capacity (1) A	Short Circuit Current (conductor) kA
3x25 + 3x16/3E + 3x2,5ST + 6UELKON		5DM1***	6.4	46.4	49.4	3210	1125	0.795	0.24	0.36	139	3.58
3x35 + 3x25/3E + 3x2,5ST + 6UELKON	20267018	5DM1***	7.6	48.7	52.7	3730	1575	0.565	0.27	0.34	172	5.01
3x50 + 3x25/3E + 3x2,5ST + 6UELKON		5DM1***	9.1	53.7	57.7	4700	2250	0.393	0.3	0.32	215	7.15
3x70 + 3x35/3E + 3x2,5ST + 6UELKON	20024471	5DM1360	10.9	58	62	5990	3150	0.277	0.34	0.31	265	10.01
3x95 + 3x50/3E + 3x2,5ST + 6UELKON	20040372	5DM1361	12.6	61.6	65.6	7080	4275	0.21	0.38	0.29	319	13.59
3x120 + 3x70/3E + 3x2,5ST + 6UELKON		5DM1***	14.2	67.2	71.2	8490	5400	0.164	0.42	0.29	371	17.16

(1) Nominal current carrying capacity for rubber cables laid on a surface, at 30°C ambient temperature (see also VDE 0298-4, Table 15). For derating-factors see tables in Technical Appendix

PROTOMONT TBM (N)TSCGECW0EU 12/20 kV

Number of cores x cross section	Part number	MLFB Number	Conductor diameter max. mm	Outer diameter min. mm	Outer diameter max. mm	Weight (approx.) kg/km	Permissible tensile force max. N	Conductor resistance at 20°C max. Ω/km	Nominal operating capacitance μF/km	Inductance nom. mH/km	Current carrying capacity (1) A	Short Circuit Current (conductor) kA
3x25 + 3x16/3E + 3x2,5ST + 6UELKON	20005062	5DM1335	6.4	48.8	52.8	3740	1125	0.795	0.22	0.37	139	3.58
3x35 + 3x25/3E + 3x2,5ST + 6UELKON	20005063	5DM1336	7.6	51.3	55.3	4270	1575	0.565	0.24	0.35	172	5.01
3x50 + 3x25/3E + 3x2,5ST + 6UELKON	20005064	5DM1354	9.1	56.7	60.7	5270	2250	0.393	0.27	0.33	215	7.15
3x70 + 3x35/3E + 3x2,5ST + 6UELKON	20081491	5DM1337	10.9	61.3	65.3	6390	3150	0.277	0.31	0.32	265	10.01
3x95 + 3x50/3E + 3x2,5ST + 6UELKON	20113405	5DM1338	12.6	66.4	70.4	7770	4275	0.21	0.34	0.3	319	13.59
3x120 + 3x70/3E + 3x2,5ST + 6UELKON	20015054	5DM1340	14.2	70.2	74.2	9160	5400	0.164	0.38	0.29	371	17.16
3x150 + 3x70/3E + 3x2,5ST + 6UELKON	20052428	5DM1341	15.8	71.1	75.1	9820	6750	0.129	0.42	0.28	428	21.45
3x185 + 3x95/3E + 3x2,5ST + 6UELKON		5DM1***	17.8	71.2	75.2	10200	8325	0.106	0.64	0.26	488	26.46
3x240 + 3x120/3E + 3x2,5ST + 6UELKON		5DM1***	20.4	74.5	78.5	11800	10800	0.0801	0.69	0.25	574	34.32

PROTOMONT TBM (N)TSCGECW0EU 14/25 kV

Number of cores x cross section	MLFB Number	Conductor diameter max. mm	Outer diameter min. mm	Outer diameter max. mm	Weight (approx.) kg/km	Permissible tensile force max. N	Conductor resistance at 20°C max. Ω/km	Nominal operating capacitance μF/km	Inductance nom. mH/km	Current carrying capacity (1) A	Short Circuit Current (conductor) kA
3x25 + 3x16/3E + 3x2,5ST + 6UELKON	5DM1***	6.4	54.6	58.6	4100	1125	0.795	0.19	0.4	139	3.58
3x35 + 3x25/3E + 3x2,5ST + 6UELKON	5DM1***	7.6	57.1	61.1	4640	1575	0.565	0.21	0.37	172	5.01
3x50 + 3x25/3E + 3x2,5ST + 6UELKON	5DM1***	9.1	61	65	5550	2250	0.393	0.23	0.35	215	7.15
3x70 + 3x35/3E + 3x2,5ST + 6UELKON	5DM1***	10.9	66.6	70.6	6860	3150	0.277	0.26	0.33	265	10.01
3x95 + 3x50/3E + 3x2,5ST + 6UELKON	5DM1***	12.6	70.2	74.2	8110	4275	0.21	0.29	0.32	319	13.59
3x120 + 3x70/3E + 3x2,5ST + 6UELKON	5DM1***	14.2	73.9	77.9	9450	5400	0.164	0.32	0.31	371	17.16

(1) Nominal current carrying capacity for rubber cables laid on a surface, at 30°C ambient temperature (see also VDE 0298-4, Table 15). For derating-factors see tables in Technical Appendix

PROTOMONT TBM (N)TSCGECW0EU 18/30 kV

Number of cores x cross section	MLFB Number	Conductor diameter max. mm	Outer diameter min. mm	Outer diameter max. mm	Weight (approx.) kg/km	Permissible tensile force max. N	Conductor resistance at 20°C max. Ω/km	Nominal operating capacitance μF/km	Inductance nom. mH/km	Current carrying capacity (1) A	Short Circuit Current (conductor) kA
3x25 + 3x16/3E + 3x2,5ST + 6UELKON	5DM1***	6.4	58	62	4490	1125	0.795	0.17	0.42	139	3.58
3x35 + 3x25/3E + 3x2,5ST + 6UELKON	5DM1***	7.6	60.7	64.7	5060	1575	0.565	0.18	0.39	172	5.01
3x50 + 3x25/3E + 3x2,5ST + 6UELKON	5DM1***	9.1	66.1	70.1	6220	2250	0.393	0.2	0.37	215	7.15
3x70 + 3x35/3E + 3x2,5ST + 6UELKON	5DM1***	10.9	70	74	7330	3150	0.277	0.23	0.35	265	10.01
3x95 + 3x50/3E + 3x2,5ST + 6UELKON	5DM1***	12.6	73.9	77.9	8660	4275	0.21	0.25	0.33	319	13.59
3x120 + 3x70/3E + 3x2,5ST + 6UELKON	5DM1***	14.2	78.6	83.6	10250	5400	0.164	0.27	0.32	371	17.16

(1) Nominal current carrying capacity for rubber cables laid on a surface, at 30°C ambient temperature (see also VDE 0298-4, Table 15). For derating-factors see tables in Technical Appendix

PROTOMONT TBM (N)TSCGECWHXOEU 10 kV – 20 kV

Halogen-free MV reeling cables for TBM



Application

These halogen-free cables are intended for use as reeling power supply cables for tunnel boring machines (TBM) in underground mines and for tunnel construction sites.

Global data

Brand	PROTOMONT TBM
Type designation	(N)TSCGECWHXOEU
Standard	Based on DIN VDE 0250-813
Certifications / Approvals	Fire Certificate of Russian Federation GOST-R/-K/-B

Design features

Conductor	Finely stranded copper conductor, tinned (class 5)
PE-Conductor	Single concentric copper/textile mixed braid over every core
Insulation	PROTOLON, Basic material: EPR, Compound type: special compound
Electrical field control	Inner and outer protective layer of semiconductive rubber compound
Core identification	Main cores: Natural coloring with black semiconductive rubber, Control cores: Black
Core arrangement	Three main conductors laid-up with three control cores in the outer interstice
Inner sheath	Vulcanized rubber inner sheath, Basic material: EPR, Compound type: GM1B
Monitoring conductor	Overall concentric lay of copper wire spinning
Outer sheath	Synthetic halogen-free elastomer compound EVA, type: 5GM3
Outer sheath colour	Red

Electrical parameters

Rated voltage	6/10 kV	12/20 kV
Max. permissible operating voltage AC	6,9/12 kV	13,9/24 kV
Max. permissible operating voltage DC	9/18 kV	18/36 kV
AC test voltage	17 kV	29 kV
AC test voltage - control cores	2 kV	2 kV

Chemical parameters

Performance against fire	IEC 60332-1-2
Resistance to oil	IEC 60811-404
Weather resistance	Unrestricted use outdoors and indoors, resistant to ozone and moisture

Thermal parameters

Max. operating temperature of the conductor	90 °C
Max. short circuit temperature of the conductor	250 °C
Ambient temperature for fixed installation	min -40 °C ; max +80 °C
Ambient temperature in fully flexible operation	min -20 °C ; max +60 °C

Mechanical parameters

Max. tensile load	For reeling application: max. 15 N/mm ² For TBM application: max. 30 N/mm ²
Torsional stress +/-	25 °/m
Bending radii min.	Acc. to DIN VDE 0298 part 3
Min. distance with S-type directional changes	20 x D
Travel speed	max. 30 m/min

PROTOMONT TBM (N)TSCGECWHXOEU 6/10 kV

Number of cores x cross section	Part number	MLFB Number	Conductor diameter max. mm	Outer diameter min. mm	Outer diameter max. mm	Weight (approx.) kg/km	Permissible tensile force max. N	Conductor resistance at 20°C max. Ω/km	Nominal operating capacitance μF/km	Inductance nom. mH/km	Current carrying capacity (1) A	Short Circuit Current (conductor) kA
3x25 + 3x16/3E + 3x2,5ST + 6UELKON		5DM1***	6.4	42.9	45.9	2880	1125	0.795	0.31	0.33	131	3.58
3x35 + 3x25/3E + 3x2,5ST + 6UELKON		5DM1***	7.6	45.6	48.6	3440	1575	0.565	0.35	0.32	162	5.01
3x50 + 3x25/3E + 3x2,5ST + 6UELKON		5DM1332	9.1	48.3	52.3	3850	2250	0.393	0.4	0.3	202	7.15
3x70 + 3x35/3E + 3x2,5ST + 6UELKON		5DM1333	10.9	54.5	58.5	5350	3150	0.277	0.46	0.29	250	10.01
3x95 + 3x50/3E + 3x2,5ST + 6UELKON	20261201	5DM1***	12.6	58.2	62.2	6550	4275	0.21	0.52	0.27	301	13.59
3x120 + 3x70/3E + 3x2,5ST + 6UELKON	20271793	5DM1430	14.2	62.1	66.1	7870	5400	0.164	0.57	0.27	352	17.16
3x150 + 3x70/3E + 3x2,5ST + 6UELKON		5DM1***	15.8	66.6	70.6	8490	6750	0.129	0.63	0.26	404	21.45
3x185 + 3x95/3E + 3x2,5ST + 6UELKON		5DM1***	17.8	67.2	71.2	9600	8325	0.106	0.64	0.26	461	26.46
3x240 + 3x120/3E + 3x2,5ST + 6UELKON		5DM1***	20.4	70.5	74.5	11200	10800	0.0801	0.64	0.25	540	34.32

PROTOMONT TBM (N)TSCGECWHXOEU 12/20 kV

Number of cores x cross section	Part number	MLFB Number	Conductor diameter max. mm	Outer diameter min. mm	Outer diameter max. mm	Weight (approx.) kg/km	Permissible tensile force max. N	Conductor resistance at 20°C max. Ω/km	Nominal operating capacitance μF/km	Inductance nom. mH/km	Current carrying capacity (1) A	Short Circuit Current (conductor) kA
3x25 + 3x16/3E + 3x2,5ST + 6UELKON		5DM1***	6.4	48.7	52.7	3540	1125	0.795	0.22	0.37	139	3.58
3x35 + 3x25/3E + 3x2,5ST + 6UELKON	20111560	5DM1435	7.6	51.1	55.1	4310	1575	0.565	0.24	0.35	172	5.01
3x50 + 3x25/3E + 3x2,5ST + 6UELKON	20121232	5DM1436	9.1	56.7	60.7	5310	2250	0.393	0.27	0.33	215	7.15
3x70 + 3x35/3E + 3x2,5ST + 6UELKON		5DM1***	10.9	61.2	65.2	6150	3150	0.277	0.31	0.32	265	10.01
3x95 + 3x50/3E + 3x2,5ST + 6UELKON	20121231	5DM1438	12.6	66.4	70.4	7820	4275	0.21	0.34	0.3	319	13.59
3x120 + 3x70/3E + 3x2,5ST + 6UELKON		5DM1***	14.2	70.1	74.1	8580	5400	0.164	0.38	0.29	371	17.16
3x150 + 3x70/3E + 3x2,5ST + 6UELKON		5DM1***	15.8	70.8	74.8	9492	6750	0.129	0.42	0.28	428	21.45
3x185 + 3x95/3E + 3x2,5ST + 6UELKON		5DM1***	17.8	71.2	75.2	10200	8325	0.106	0.64	0.26	488	26.46
3x240 + 3x120/3E + 3x2,5ST + 6UELKON		5DM1***	20.4	74.5	78.5	11800	10800	0.0801	0.69	0.25	574	34.32

(1) Nominal current carrying capacity for rubber cables laid on a surface, at 30°C ambient temperature (see also VDE 0298-4, Table 15). For derating-factors see tables in Technical Appendix

TENAX-HTT (N)TSCGEW0EU 10 kV – 30 kV

MV reeling cables for use on TBMs



Application

For the connection of electrical equipment, in mines and underground excavations with hazardous environments under particularly high mechanical loads, e.g. high-voltage transformers on power lines in underground mining and tunneling. The flexible cable design allows for movement of the equipment during operation and even slow reeling operations

Global data

Brand	TENAX-HTT
Type designation	(N)TSCGEW0EU
Standard	Based on DIN VDE 0250-813
Certifications / Approvals	Fire Certificate of Russian Federation GOST -R/-K/-B

Design features

Conductor	Bare copper conductor, finely stranded (class 5)
PE-Conductor	Concentric spinning of tinned annealed copper wires over each core
Insulation	Rubber, Compound type: 3GI3 according to DIN VDE 0207 part 20
Core identification	According to DIN VDE 0250 Pt. 813, Natural colour
Inner sheath	Rubber, Compound type: GM1B according to DIN VDE 0207 part 21
Torsion protection	Polyester anti-torsion braid between the jackets embedded
Outer sheath	Rubber, Compound type: 5GM5 according to DIN VDE 0207 part 21, Color: Red

Electrical parameters

Rated voltage	6/10 kV	8.7/15 kV	12/20 kV	14/25 kV	18/30 kV
Max. permissible operating voltage AC	6,9/12 kV	10.4/18 kV	13.9/24 kV	17.3/30 kV	20.8/36 kV
Max. permissible operating voltage DC	9/18 kV	13.5/27 kV	18/36 kV	22.5/45 kV	27/54 kV
AC test voltage	17 kV	24 kV	29 kV	36 kV	43 kV
AC test voltage - control cores	2 kV	2 kV	2 kV	2 kV	2 kV

Chemical parameters

Performance against fire	EN 60332-1-2, IEC 60332-1-2
Resistance to oil	EN 60811-404, IEC 60811-404

Thermal parameters

Max. short circuit temperature of the conductor	250 °C
Ambient temperature for fixed installation	min -40 °C ; max +80 °C
Ambient temperature in fully flexible operation	min -25 °C ; max +60 °C

Mechanical parameters

Max. tensile load on the conductor	15 N/mm ²
Torsional stress +/-	100 °/m
Bending radii min.	Acc. to DIN VDE 0298 part 3
Travel speed	max. 30 m/min

TENAX-HTT (N)TSCGEW0EU 6/10 kV

Number of cores x cross section	Part number	Conductor diameter max. mm	Outer diameter min. mm	Outer diameter max. mm	Weight (approx.) kg/km	Permissible tensile force max. N	Conductor resistance at 20°C max. Ω/km	Nominal operating capacitance μF/km	Inductance nom. mH/km	Current carrying capacity (1) A	Short Circuit Current (conductor) kA
3x25x3x16/3E		6.2	45.6	49.1	2975	1125	0.78	0.23	0.37	131	3.58
3x35+3x25/3E		7.8	50.8	55.3	3825	1575	0.554	0.27	0.34	162	5.01
3x50+3x25/3E		9.6	54.7	59.2	4525	2250	0.386	0.31	0.32	202	7.15
3x70+3x35/3E		10.6	56.9	61.4	5325	3150	0.272	0.34	0.31	250	10.01
3x95+3x50/3E		12.6	63.4	67.9	7075	4275	0.206	0.38	0.29	301	13.59
3x120+3x70/3E	20196517	14.8	68.6	73.1	8550	5400	0.161	0.44	0.28	352	17.16
3x150+3x70/3E	20275551	16	71.1	75.6	9300	6750	0.129	0.46	0.28	404	21.45
3x25x3x16/3E + 3x2,5ST		6.2	45.6	49.1	2975	1125	0.78	0.23	0.37	131	3.58
3x35 + 3x25/3E + 3x2,5ST		7.8	50.8	55.3	3825	1575	0.554	0.27	0.34	162	5.01
3x50 + 3x25/3E + 3x2,5ST		9.6	54.7	59.2	4525	2250	0.386	0.31	0.32	202	7.15
3x70 + 3x35/3E + 3x2,5ST	20197569	10.6	56.9	61.4	5325	3150	0.272	0.34	0.31	250	10.01
3x95 + 3x50/3E + 3x2,5ST	20197565	12.6	63.4	67.9	7075	4275	0.206	0.38	0.29	301	13.59
3x120 + 3x70/3E + 3x2,5ST		14.8	68.6	73.1	8550	5400	0.161	0.44	0.28	352	17.16
3x150 + 3x70/3E + 3x2,5ST		16	71.1	75.6	9300	6750	0.129	0.46	0.28	404	21.45

TENAX-HTT (N)TSCGEW0EU 8.7/15 kV

Number of cores x cross section	Part number	Conductor diameter max. mm	Outer diameter min. mm	Outer diameter max. mm	Weight (approx.) kg/km	Permissible tensile force max. N	Conductor resistance at 20°C max. Ω/km	Nominal operating capacitance μF/km	Inductance nom. mH/km	Current carrying capacity (1) A	Short Circuit Current (conductor) kA
3x25x3x16/3E		6.2	51.7	56.2	3625	1125	0.78	0.19	0.39	139	3.58
3x35+3x25/3E		7.8	55.2	59.7	4275	1575	0.554	0.22	0.36	172	5.01
3x50+3x25/3E		9.6	59.1	63.6	5050	2250	0.386	0.25	0.34	215	7.15
3x70+3x35/3E		10.6	63.4	67.9	6250	3150	0.272	0.27	0.33	265	10.01
3x95+3x50/3E	20179572	12.6	68.2	72.7	8260	4275	0.206	0.31	0.31	319	13.59
3x120+3x70/3E	20079289	14.8	71.5	76	8490	5400	0.161	0.35	0.3	371	17.16
3x150+3x70/3E	20173116	16	77.7	82.2	10630	6750	0.129	0.37	0.29	428	21.45
3x185+3x95/3E	20183101	17.7	78	82	12680	8325	0.106	0.4	0.29	488	26.46
3x240+3x120/3E	20183102	18.7	79.5	84.5	13700	10800	0.0801	0.44	0.28	574	34.32
3x25x3x16/3E + 3x2,5ST		6.2	51.7	56.2	3675	1125	0.78	0.19	0.39	139	3.58
3x35 + 3x25/3E + 3x2,5ST		7.8	55.2	59.7	4325	1575	0.554	0.22	0.36	172	5.01
3x50 + 3x25/3E + 3x2,5ST		9.6	59.1	63.6	5100	2250	0.386	0.25	0.34	215	7.15
3x70 + 3x35/3E + 3x2,5ST		10.6	63.4	67.9	6300	3150	0.272	0.27	0.33	265	10.01
3x95 + 3x50/3E + 3x2,5ST		12.6	68.2	72.7	7825	4275	0.206	0.31	0.31	319	13.59
3x120 + 3x70/3E + 3x2,5ST		14.8	75.2	79.7	9725	5400	0.161	0.35	0.3	371	17.16
3x150 + 3x70/3E + 3x2,5ST		16	77.7	82.2	10425	6750	0.129	0.37	0.29	428	21.45
3x185 + 3x95/3E + 3x2,5ST		17.7	78	82	12730	8325	0.106	0.4	0.29	488	26.46
3x240 + 3x120/3E + 3x2,5ST		18.7	79.5	84.5	13750	10800	0.0801	0.44	0.28	574	34.32

(1) Nominal current carrying capacity for rubber cables laid on a surface, at 30°C ambient temperature (see also VDE 0298-4, Table 15). For derating-factors see tables in Technical Appendix

TENAX-HTT (N)TSCGEWOU 12/20 kV

Number of cores x cross section	Part number	Conductor diameter max. mm	Outer diameter min. mm	Outer diameter max. mm	Weight (approx.) kg/km	Permissible tensile force max. N	Conductor resistance at 20°C max. Ω/km	Nominal operating capacitance μF/km	Inductance nom. mH/km	Current carrying capacity (1) A	Short Circuit Current (conductor) kA
3x25x3x16/3E		6.2	56	60.5	4125	1125	0.78	0.17	0.41	139	3.58
3x35+3x25/3E		7.8	59.9	64.4	4875	1575	0.554	0.19	0.38	172	5.01
3x50+3x25/3E		9.6	65.6	70.1	5950	2250	0.386	0.22	0.36	215	7.15
3x70+3x35/3E		10.6	68.2	72.7	6925	3150	0.272	0.23	0.35	265	10.01
3x95+3x50/3E	20213199	12.6	74.3	78.8	9230	4275	0.206	0.26	0.33	319	13.59
3x120+3x70/3E		14.8	79.5	84	10400	5400	0.161	0.29	0.31	371	17.16
3x150+3x70/3E		16	82	86.5	11175	6750	0.129	0.31	0.31	428	21.45
3x25x3x16/3E + 3x2,5ST		6.2	56	60.5	4175	1125	0.78	0.17	0.41	139	3.58
3x35 + 3x25/3E + 3x2,5ST		7.8	59.9	64.4	4925	1575	0.554	0.19	0.38	172	5.01
3x50+3x25/3E + 3x2,5ST	20227840	9.6	65.5	70	6820	2250	0.386	0.22	0.36	215	7.15
3x70 + 3x35/3E + 3x2,5ST	20197567	10.6	68.2	72.7	6930	3150	0.272	0.23	0.35	265	10.01
3x95 + 3x50/3E + 3x2,5ST	20197566	12.6	74.3	78.8	8780	4275	0.206	0.26	0.33	319	13.59
3x120 + 3x70/3E + 3x2,5ST		14.8	79.5	84	10450	5400	0.161	0.29	0.31	371	17.16
3x150 + 3x70/3E + 3x2,5ST		16	82	86.5	11225	6750	0.129	0.31	0.31	428	21.45

TENAX-HTT (N)TSCGEWOU 14/25 kV

Number of cores x cross section	Conductor diameter max. mm	Outer diameter min. mm	Outer diameter max. mm	Weight (approx.) kg/km	Permissible tensile force max. N	Conductor resistance at 20°C max. Ω/km	Nominal operating capacitance μF/km	Inductance nom. mH/km	Current carrying capacity (1) A	Short Circuit Current (conductor) kA
3x25x3x16/3E	6.2	63.5	68	5150	1125	0.78	0.15	0.44	139	3.58
3x35+3x25/3E	7.8	67.3	71.8	5975	1575	0.554	0.17	0.41	172	5.01
3x50+3x25/3E	9.6	71.2	75.7	6850	2250	0.386	0.19	0.38	215	7.15
3x70+3x35/3E	10.6	75.6	80.1	8150	3150	0.272	0.2	0.37	265	10.01
3x95+3x50/3E	12.6	79.9	84.4	9800	4275	0.206	0.22	0.35	319	13.59
3x120+3x70/3E	14.8	86.9	91.4	11875	5400	0.161	0.25	0.33	371	17.16
3x150+3x70/3E	16	89.4	93.9	12700	6750	0.129	0.27	0.32	428	21.45
3x25x3x16/3E + 3x2,5ST	6.2	63.5	68	5200	1125	0.78	0.15	0.44	139	3.58
3x35 + 3x25/3E + 3x2,5ST	7.8	67.3	71.8	6025	1575	0.554	0.17	0.41	172	5.01
3x50 + 3x25/3E + 3x2,5ST	9.6	71.2	75.7	6900	2250	0.386	0.19	0.38	215	7.15
3x70 + 3x35/3E + 3x2,5ST	10.6	75.6	80.1	8200	3150	0.272	0.2	0.37	265	10.01
3x95 + 3x50/3E + 3x2,5ST	12.6	79.9	84.4	9850	4275	0.206	0.22	0.35	319	13.59
3x120 + 3x70/3E + 3x2,5ST	14.8	86.9	91.4	11925	5400	0.161	0.25	0.33	371	17.16
3x150 + 3x70/3E + 3x2,5ST	16	89.4	93.9	12750	6750	0.129	0.27	0.32	428	21.45

(1) Nominal current carrying capacity for rubber cables laid on a surface, at 30°C ambient temperature (see also VDE 0298-4, Table 15). For derating-factors see tables in Technical Appendix

TENAX-HTT (N)TSCGEW0EU 18/30 kV

Number of cores x cross section	Conductor diameter max. mm	Outer diameter min. mm	Outer diameter max. mm	Weight (approx.) kg/km	Permissible tensile force max. N	Conductor resistance at 20°C max. Ω/km	Nominal operating capacitance μF/km	Inductance nom. mH/km	Current carrying capacity (1) A	Short Circuit Current (conductor) kA
3x25x3x16/3E	6.2	68.6	73.1	5950	1125	0.78	0.13	0.46	139	3.58
3x35+3x25/3E	7.8	74.3	78.8	7125	1575	0.554	0.15	0.43	172	5.01
3x50+3x25/3E	9.6	78.2	82.7	8050	2250	0.386	0.17	0.4	215	7.15
3x70+3x35/3E	10.6	80.8	85.3	9100	3150	0.272	0.18	0.39	265	10.01
3x95+3x50/3E	12.6	86.9	91.4	11150	4275	0.206	0.2	0.37	319	13.59
3x120+3x70/3E	14.8	91.7	96.2	12775	5400	0.161	0.22	0.35	371	17.16
3x150+3x70/3E	16	94.2	98.7	13600	6750	0.129	0.23	0.34	428	21.45
3x25x3x16/3E + 3x2,5ST	6.2	68.6	73.1	6000	1125	0.78	0.13	0.46	139	3.58
3x35 + 3x25/3E + 3x2,5ST	7.8	74.3	78.8	7175	1575	0.554	0.15	0.43	172	5.01
3x50 + 3x25/3E + 3x2,5ST	9.6	78.2	82.7	8100	2250	0.386	0.17	0.4	215	7.15
3x70 + 3x35/3E + 3x2,5ST	10.6	80.8	85.3	9150	3150	0.272	0.18	0.39	265	10.01
3x95 + 3x50/3E + 3x2,5ST	12.6	86.9	91.4	11200	4275	0.206	0.2	0.37	319	13.59
3x120 + 3x70/3E + 3x2,5ST	14.8	91.7	96.2	12825	5400	0.161	0.22	0.35	371	17.16
3x150 + 3x70/3E + 3x2,5ST	16	94.2	98.7	13650	6750	0.129	0.23	0.34	428	21.45

(1) Nominal current carrying capacity for rubber cables laid on a surface, at 30°C ambient temperature (see also VDE 0298-4, Table 15). For derating-factors see tables in Technical Appendix

PROTOMONT NTSKCGECWOEU – Festoon 3.6/6 kV

Underground festoon cable



Application

As power feeder cable in underground mines and in tunnel sites. The cables are used in underground festoon systems for the power supply of mobile transformer and shiftable units in underground mining applications.

Global data

Brand	PROTOMONT
Type designation	NTSKCGECWOEU
Standard	DIN VDE 0250-813
Certifications / Approvals	MA – China WUG – Poland BAS-Certificate Fire Certificate of Russian Federation GOST-R/-B/-K

Design features

Conductor	Finely stranded copper conductor, tinned (Class 5)
Insulation	PROTOLON, Basic material: EPR, Compound type: 3GI3
Electrical field control	Inner semiconductive layer of semiconductive rubber, outer semiconductive layer of tapes
Core identification	Power cores: Natural color, Control cores: Blue
Arrangement of PE-conductor	Concentric spinning of copper wires over each control core element in the outer interstices
Inner sheath	Basic material: EPR, Compound type: GM1B
Monitoring conductor	Semi-conductive tape and open-lay spinning of steel/copper wires
Outer sheath	PROTOFIRM, Basic material: synthetic elastomer compound e.g. CR, Compound type: 5GM5, Color: Red

Electrical parameters

Rated voltage	3.6/6 kV
Max. permissible operating voltage AC	4.2/7.2 kV
Max. permissible operating voltage DC	5.4/10.8 kV
AC test voltage	11 kV
AC test voltage - control cores	2 kV

Chemical parameters

Performance against fire	IEC 60332-1-2
Resistance to oil	IEC 60811-404.
Weather resistance	Unrestricted use outdoors and indoors, resistant to ozone, UV and moisture

Thermal parameters

Max. operating temperature of the conductor	90 °C
Max. short circuit temperature of the conductor	250 °C
Ambient temperature for fixed installation	min -40 °C ; max +80 °C
Ambient temperature in fully flexible operation	min -25 °C ; max +60 °C

Mechanical parameters

Max. tensile load on the conductor	15 N/mm ²
Bending radii min.	Acc. to DIN VDE 0298 part 3

PROTOMONT NTSKCGECW0EU – Festoon 3.6/6 kV

Number of cores x cross section	Part number	MLFB Number	Conductor diameter max. mm	Outer diameter min. mm	Outer diameter max. mm	Weight (approx.) kg/km	Permissible tensile force max. N	Conductor resistance at 20°C max. Ω/km	Nominal operating capacitance μF/km	Inductance nom. mH/km	Current carrying capacity (1) A	Short Circuit Current (conductor) kA
3x35+3x(1,5STKON + 25/3KON)+UELKON	20005043	5DM1078	8.2	47.6	50.6	3870	1575	0.565	0.28	0.3	162	5.01
3x50+3x(1,5STKON + 25/3KON)+UELKON	20005040	5DM1069	9.8	50.6	54.6	4600	2250	0.393	0.33	0.29	202	7.15
3x70+3x(1,5STKON + 35/3KON)+UELKON	20005041	5DM1070	11.3	55	59	5640	3150	0.277	0.37	0.28	250	10.01
3x95+3x(1,5STKON + 50/3KON)+UELKON	20005042	5DM1076	13.4	60.3	64.3	6910	4275	0.21	0.42	0.27	301	13.59
3x120 + 3x(1,5STKON + 70/3KON) + 6ÜLKON	20007844	5DM1085	15.1	65.8	69.8	8410	5400	0.164	0.46	0.26	352	17.16
3x150 + 3x(1,5STKON + 70/3KON) + 6ÜLKON	20053570	5DM1089	16.8	69.7	73.7	9700	6750	0.132	0.51	0.25	404	21.45
3x185+3x(1,5STKON + 95/3KON)+UELKON	20080424	5DM1187	19	70	74	12770	8325	0.108	0.59	0.25	461	26.46
NTSKCGECW0EU 3.6/6kV, six-cores design												
6X35+6X35/6E + 1X(6X1,5ST)+UELKON	20227551	5DM1191	8.2	60.2	64.2	6180	3150	0.565	0.34	0.44	110	5.01
6X50+6X50/6E + 1X(6X1,5ST)+UELKON	20269961	5DM1192	9.8	67.2	71.2	7870	4500	0.393	0.45	0.39	137	7.15
6X70+6X70/6E + 1X(6X1,5ST)+UELKON	20111554	5DM1193	11.3	71.4	75.4	9670	6300	0.277	0.58	0.35	170	10.01
6X95+6X95/6E + 1X(6X1,5ST)+UELKON		5DM1***	13.4	80.2	84.2	11900	8550	0.21	0.7	0.33	205	13.59

(1) Nominal current carrying capacity for rubber cables laid on a surface, at 30°C ambient temperature (see also VDE 0298-4, Table 15). For derating-factors see tables in Technical Appendix

SUPROMONT (N)3GHSSYCY 6 kV – 30 kV

Rubber insulated MV flexible cables for underground use



Application

As feeder cable for power supply of shiftable MV equipment, e.g. compressure resistant transformers, for underground mining applications as well as for tunnel sites.

Global data

Brand	SUPROMONT
Type designation	(N)3GHSSYCY
Standard	based on DIN VDE 0250 part 605
Certifications / Approvals	VDE certificate of conformity

Design features

Conductor	Bare electrolytic copper, finely stranded (class 5)
PE-Conductor	Individually laid-up concentrically around each main core
Insulation	PROTOLON, Basic material: EPR, Compound type: Special compound, better 3GI3
Electrical field control	Inner and outer semiconductive layer of semiconductive rubber, for 6kV outer semiconductive layer only
Core identification	Main cores: Natural color with black semiconductive layer, Control cores: Black with white digits
Core arrangement	Three main cores laid-up, one control core in each outer interstice
Inner sheath	PVC based plastic compound, type: DMV6
Monitoring conductor	Conductive tape and overall concentric copper wire spinning
Intermediate sheath	PVC based plastic compound, type: DMV6
Armouring	Braid of galvanized steel wires
Outer sheath	PVC-based thermoplastic compound, type: DMV6, Color: Red

Electrical parameters

Rated voltage	3.6/6 kV	6/10 kV	8.7/15 kV	12/20 kV	14/25 kV	18/30 kV
Max. permissible operating voltage AC	4.2/7.2 kV	6.9/12 kV	10.4/18 kV	13.9/24 kV	17.3/30 kV	20.8/36 kV
Max. permissible operating voltage DC	5.4/10.8 kV	9/18 kV	13.5/27 kV	18/36 kV	22.5/45 kV	27/54 kV
AC test voltage	11 kV	17 kV	24 kV	29 kV	43 kV	43 kV
AC test voltage - control cores	2 kV	2 kV	2 kV	2 kV	2 kV	2 kV

Chemical parameters

Performance against fire	IEC 60332-1-2
Weather resistance	Unrestricted use indoors and in underground mines according to DIN VDE 0118, resistant to ozone and moisture

Thermal parameters

Max. operating temperature of the conductor	90 °C
Max. short circuit temperature of the conductor	250 °C
Ambient temperature for fixed installation	min -40 °C ; max +80 °C
Ambient temperature in fully flexible operation	min 5 °C ; max +60 °C

Mechanical parameters

Max. tensile load on the conductor	15 N/mm ²
Bending radii min.	Acc. to DIN VDE 0298 part 3

SUPROMONT (N)3GHSSYCY 3.6/6 kV

Number of cores x cross section	Part number	MLFB Number	Conductor diameter max. mm	Outer diameter min. mm	Outer diameter max. mm	Weight (approx.) kg/km	Permissible tensile force max. N	Conductor resistance at 20°C max. Ω/km	Nominal operating capacitance μF/km	Inductance nom. mH/km	Current carrying capacity (1) A	Short Circuit Current (conductor) kA
3x25+3x16/3E + 3x2,5ST+UEL	20161631	5DM2031	6.4	42.7	45.7	3180	1125	0.78	0.36	0.32	131	3.58
3x35+3x16/3E + 3x2,5ST+UEL	20112385	5DM2032	7.6	45.3	48.3	3700	1575	0.554	0.41	0.3	162	5.01
3x50+3x25/3E + 3x2,5ST+UEL	20042591	5DM2033	9.1	49.5	53.5	4730	2250	0.386	0.47	0.29	202	7.15
3x70+3x35/3E + 3x2,5ST+UEL	20203072	5DM2034	10.8	53.2	57.2	5720	3150	0.272	0.53	0.28	250	10.01
3x95+3x50/3E + 3x2,5ST+UEL	20049961	5DM2035	12.7	58.2	62.2	7010	4275	0.206	0.61	0.27	301	13.59
3x120+3x70/3E + 3x2,5ST+UEL	20203073	5DM2036	14.3	62.7	66.7	8311	5400	0.161	0.67	0.26	352	17.16
3x150+3x70/3E + 3x2,5ST+UEL		5DM2	16	67.6	71.6	9634	6750	0.129	0.74	0.25	404	21.45
3x185+3x120/3E + 3x2,5ST+UEL		5DM2	17.7	71.7	75.7	11202	8325	0.106	0.8	0.25	461	26.46

SUPROMONT (N)3GHSSYCY 6/10 kV

Number of cores x cross section	Part number	MLFB Number	Conductor diameter max. mm	Outer diameter min. mm	Outer diameter max. mm	Weight (approx.) kg/km	Permissible tensile force max. N	Conductor resistance at 20°C max. Ω/km	Nominal operating capacitance μF/km	Inductance nom. mH/km	Current carrying capacity (1) A	Short Circuit Current (conductor) kA
3x25+3x16/3E + 3x2,5ST+UEL	20156248	5DM2121	6.4	45.7	48.7	3580	1125	0.78	0.32	0.33	131	3.58
3x35+3x16/3E + 3x2,5ST+UEL	20005081	5DM2122	7.6	47.8	50.8	4130	1575	0.554	0.36	0.31	162	5.01
3x50+3x25/3E + 3x2,5ST+UEL	20005082	5DM2123	9.1	50.8	54.8	4890	2250	0.386	0.42	0.3	202	7.15
3x70+3x35/3E + 3x2,5ST+UEL	20133422	5DM2124	10.8	55.1	59.1	5680	3150	0.272	0.47	0.28	250	10.01
3x95+3x50/3E + 3x2,5ST+UEL	20005083	5DM2125	12.7	60	64	7130	4275	0.206	0.54	0.27	301	13.59
3x120+3x70/3E + 3x2,5ST+UEL	20005084	5DM2126	14.3	63.9	67.9	8450	5400	0.161	0.59	0.26	352	17.16
3x150+3x70/3E + 3x2,5ST+UEL	20275552	5DM2***	16	68.9	72.9	9840	6750	0.129	0.66	0.25	404	21.45
3x185+3x120/3E + 3x2,5ST+UEL		5DM2	17.7	73	77	11408	8325	0.106	0.74	0.25	461	26.46

(1) Nominal current carrying capacity for rubber cables laid on a surface, at 30°C ambient temperature (see also VDE 0298-4, Table 15). For derating-factors see tables in Technical Appendix

SUPROMONT (N)3GHSSYCY 8.7/15 kV

Number of cores x cross section	Part number	MLFB Number	Conductor diameter max. mm	Outer diameter min. mm	Outer diameter max. mm	Weight (approx.) kg/km	Permissible tensile force max. N	Conductor resistance at 20°C max. Ω/km	Nominal operating capacitance μF/km	Inductance nom. mH/km	Current carrying capacity (1) A	Short Circuit Current (conductor) kA
3x25+3x16/3E + 3x2,5ST+UEL		5DM2131	6.4	49.1	53.1	3985	1125	0.78	0.22	0.36	139	3.58
3x35+3x16/3E + 3x2,5ST+UEL		5DM2132	7.6	50.4	54.4	4481	1575	0.554	0.29	0.33	172	5.01
3x50+3x25/3E + 3x2,5ST+UEL	20194633	5DM2133	9.1	53.9	57.9	5300	2250	0.386	0.33	0.31	215	7.15
3x70+3x35/3E + 3x2,5ST+UEL	20227835	5DM2134	10.8	57.6	61.6	6380	3150	0.272	0.38	0.3	265	10.01
3x95+3x50/3E + 3x2,5ST+UEL		5DM2135	12.7	63.1	67.1	7652	4275	0.206	0.43	0.29	319	13.59
3x120+3x70/3E + 3x2,5ST+UEL	20181158	5DM2136	14.3	67.4	71.4	8940	5400	0.161	0.47	0.28	371	17.16
3x150+3x70/3E + 3x2,5ST+UEL	20269302	5DM2***	16	72	76	10400	6750	0.129	0.54	0.27	428	21.45
3x185+3x120/3E + 3x2,5ST+UEL		5DM2	17.7	75.6	79.6	11865	8325	0.106	0.58	0.26	488	26.46

SUPROMONT (N)3GHSSYCY 12/20 kV

Number of cores x cross section	Part number	MLFB Number	Conductor diameter max. mm	Outer diameter min. mm	Outer diameter max. mm	Weight (approx.) kg/km	Permissible tensile force max. N	Conductor resistance at 20°C max. Ω/km	Nominal operating capacitance μF/km	Inductance nom. mH/km	Current carrying capacity (1) A	Short Circuit Current (conductor) kA
3x25+3x16/3E + 3x2,5ST+UEL	20137435	5DM2211	6.4	52.6	56.6	3900	1575	0.554	0.2	0.37	172	5.01
3x35+3x16/3E + 3x2,5ST+UEL	20015843	5DM2212	7.6	53.6	57.6	5090	1125	0.7839	0.25	0.35	139	3.58
3x50+3x25/3E + 3x2,5ST+UEL	20007713	5DM2213	9.1	56.8	60.8	5730	2250	0.386	0.28	0.33	215	7.15
3x70+3x35/3E + 3x2,5ST+UEL	20217439	5DM2214	10.8	61	65	6840	3150	0.272	0.32	0.31	265	10.01
3x95+3x50/3E + 3x2,5ST+UEL	20111613	5DM2215	12.7	66	70	8080	4275	0.206	0.36	0.3	319	13.59
3x120+3x70/3E + 3x2,5ST+UEL	20113362	5DM2216	14.3	69.9	73.9	9650	5400	0.161	0.39	0.29	371	17.16
3x150+3x70/3E + 3x2,5ST+UEL	20135152	5DM2***	16	71	75	10932	6750	0.129	0.43	0.28	428	21.45
3x185+3x120/3E + 3x2,5ST+UEL		5DM2	17.7	78.7	82.7	12417	8325	0.106	0.47	0.27	488	26.46

(1) Nominal current carrying capacity for rubber cables laid on a surface, at 30°C ambient temperature (see also VDE 0298-4, Table 15). For derating-factors see tables in Technical Appendix

SUPROMONT (N)3GHSSYCY 14/25 kV

Number of cores x cross section	Part number	MLFB Number	Conductor diameter max. mm	Outer diameter min. mm	Outer diameter max. mm	Weight (approx.) kg/km	Permissible tensile force max. N	Conductor resistance at 20°C max. Ω/km	Nominal operating capacitance μF/km	Inductance nom. mH/km	Current carrying capacity (1) A	Short Circuit Current (conductor) kA
3x35+3x16/3E + 3x2,5ST+UEL		5DM2	7.6	57.6	61.6	5502	1575	0.554	0.21	0.37	172	5.01
3x50+3x25/3E + 3x2,5ST+UEL	20292042	5DM2	9.1	61.4	65.4	6517	2250	0.386	0.24	0.35	215	7.15
3x70+3x35/3E + 3x2,5ST+UEL		5DM2	10.8	65	69	7526	3150	0.272	0.27	0.33	265	10.01
3x95+3x50/3E + 3x2,5ST+UEL		5DM2	12.7	70	73.9	8790	4275	0.206	0.3	0.32	319	13.59
3x120+3x70/3E + 3x2,5ST+UEL		5DM2	14.3	73.9	77.8	10137	5400	0.161	0.33	0.3	371	17.16
3x150+3x70/3E + 3x2,5ST+UEL		5DM2	16	78.9	82.8	11679	6750	0.129	0.36	0.29	428	21.45
3x185+3x95/3E + 3x2,5ST+UEL		5DM2	17.7	82.5	86.4	13095	8325	0.106	0.39	0.29	488	26.46

SUPROMONT (N)3GHSSYCY 18/30 kV

Number of cores x cross section	MLFB Number	Conductor diameter max. mm	Outer diameter min. mm	Outer diameter max. mm	Weight (approx.) kg/km	Permissible tensile force max. N	Conductor resistance at 20°C max. Ω/km	Nominal operating capacitance μF/km	Inductance nom. mH/km	Current carrying capacity (1) A	Short Circuit Current (conductor) kA
3x50+3x25/3E + 3x2,5ST+UEL	5DM2	9.1	67.4	71.4	7487	2250	0.386	0.2	0.37	215	7.15
3x70+3x35/3E + 3x2,5ST+UEL	5DM2	10.8	71.1	75.1	8549	3150	0.272	0.22	0.35	265	10.01
3x95+3x50/3E + 3x2,5ST+UEL	5DM2	12.7	76.5	80.4	10091	4275	0.206	0.25	0.34	319	13.59
3x120+3x70/3E + 3x2,5ST+UEL	5DM2	14.3	79.9	83.8	11268	5400	0.161	0.27	0.33	371	17.16
3x150+3x70/3E + 3x2,5ST+UEL	5DM2	16	84.4	89.3	12887	6750	0.129	0.29	0.31	428	21.45

(1) Nominal current carrying capacity for rubber cables laid on a surface, at 30°C ambient temperature (see also VDE 0298-4, Table 15). For derating-factors see tables in Technical Appendix

SUPROMONT (N)3GHSSHCH 6 kV – 20 kV

Halogen-free rubber insulated MV flexible cables for underground use



Application

As feeder cable for power supply of shiftable MV equipment, e.g. compressure resistant transformers, for underground mining applications as well as for tunnel sites.

Global data

Brand	SUPROMONT
Type designation	(N)3GHSSHCH
Standard	based on DIN VDE 0250 part 605
Certifications / Approvals	VDE certificate of conformity

Design features

Conductor	Bare electrolytic copper, finely stranded (class 5)
PE-Conductor	Individually laid-up concentrically around each main core
Insulation	PROTOLON, Basic material: EPR, Compound type: Special compound, better 3GI3
Electrical field control	Inner and outer semiconductive layer of semiconductive rubber, for 6kV outer semiconductive layer only
Core identification	Main cores: Natural color with black semiconductive layer, Control cores: Black with white digits
Core arrangement	Three main cores laid-up, one control core in each outer interstice
Inner sheath	Thermoplastic compound, type: HM4
Monitoring conductor	Conductive tape and overall concentric copper wire spinning
Intermediate sheath	Thermoplastic compound, type: HM4
Armouring	Braid of galvanized steel wires
Outer sheath	Thermoplastic compound, type: HM4, Color: Red

Electrical parameters

Rated voltage	3.6/6 kV	6/10 kV	8.7/15 kV	12/20 kV
Max. permissible operating voltage AC	4.2/7.2 kV	6,9/12 kV	10.4/18 kV	13.9/24 kV
Max. permissible operating voltage DC	5.4/10.8 kV	9/18 kV	13.5/27 kV	18/36 kV
AC test voltage	11 kV	17 kV	24 kV	29 kV
AC test voltage - control cores	2 kV	2 kV	2 kV	2 kV

Chemical parameters

Performance against fire	IEC 60332-1-2
Weather resistance	Unrestricted use indoors and in underground mines according to DIN VDE 0118, resistant to ozone and moisture

Thermal parameters

Max. operating temperature of the conductor	90 °C
Max. short circuit temperature of the conductor	250 °C
Ambient temperature for fixed installation	min -40 °C ; max +80 °C
Ambient temperature in fully flexible operation	min 5 °C ; max +80 °C

Mechanical parameters

Max. tensile load on the conductor	15 N/mm ²
Bending radii min.	Acc. to DIN VDE 0298 part 3

SUPROMONT (N)3GHSSHCH 3.6/6 kV

Number of cores x cross section	MLFB Number	Conductor diameter max. mm	Outer diameter min. mm	Outer diameter max. mm	Weight (approx.) kg/km	Permissible tensile force max. N	Conductor resistance at 20°C max. Ω/km	Nominal operating capacitance μF/km	Inductance nom. mH/km	Current carrying capacity (1) A	Short Circuit Current (conductor) kA
3x25+3x16/3E + 3x2,5ST+UEL	5DM2***	6.4	42.7	45.7	3178	1125	0.78	0.36	0.32	131	3.58
3x35+3x16/3E + 3x2,5ST+UEL	5DM2***	7.6	45.3	48.3	3696	1575	0.554	0.41	0.3	162	5.01
3x50+3x25/3E + 3x2,5ST+UEL	5DM2***	9.1	48.5	52.5	4508	2250	0.386	0.47	0.29	202	7.15
3x70+3x35/3E + 3x2,5ST+UEL	5DM2***	10.8	52.1	56.1	5437	3150	0.272	0.53	0.28	250	10.01
3x95+3x50/3E + 3x2,5ST+UEL	5DM2***	12.7	56.6	60.6	6638	4275	0.206	0.61	0.27	301	13.59
3x120+3x70/3E + 3x2,5ST+UEL	5DM2***	14.3	60.5	64.5	7953	5400	0.161	0.67	0.26	352	17.16
3x150+3x70/3E + 3x2,5ST+UEL	5DM2***	16.1	65	71	9150	6750	0.129	0.74	0.25	404	21.45

SUPROMONT (N)3GHSSHCH 6/10 kV

Number of cores x cross section	Part number	MLFB Number	Conductor diameter max. mm	Outer diameter min. mm	Outer diameter max. mm	Weight (approx.) kg/km	Permissible tensile force max. N	Conductor resistance at 20°C max. Ω/km	Nominal operating capacitance μF/km	Inductance nom. mH/km	Current carrying capacity (1) A	Short Circuit Current (conductor) kA
3x25+3x16/3E + 3x2,5ST+UEL		5DM2***	6.4	44.7	48.7	3586	1125	0.78	0.32	0.33	131	3.58
3x35+3x16/3E + 3x2,5ST+UEL	20148151	5DM2***	7.6	48.7	51.7	4020	1575	0.554	0.36	0.31	162	5.01
3x50+3x25/3E + 3x2,5ST+UEL	20067203	5DM2233	9.1	50.7	54.7	4840	2250	0.386	0.42	0.3	202	7.15
3x70+3x35/3E + 3x2,5ST+UEL		5DM2***	10.8	55.1	59.1	5680	3150	0.272	0.47	0.28	250	10.01
3x95+3x50/3E + 3x2,5ST+UEL	20067204	5DM2235	12.7	59.5	63.5	7090	4275	0.206	0.54	0.27	301	13.59
3x120+3x70/3E + 3x2,5ST+UEL	20275531	5DM2***	14.3	63.9	67.9	8460	5400	0.161	0.59	0.26	352	17.16

(1) Nominal current carrying capacity for rubber cables laid on a surface, at 30°C ambient temperature (see also VDE 0298-4, Table 15). For derating-factors see tables in Technical Appendix

SUPROMONT (N)3GHSSHCH 8.7/15 kV

Number of cores x cross section	Part number	MLFB Number	Conductor diameter max. mm	Outer diameter min. mm	Outer diameter max. mm	Weight (approx.) kg/km	Permissible tensile force max. N	Conductor resistance at 20°C max. Ω/km	Nominal operating capacitance μF/km	Inductance nom. mH/km	Current carrying capacity (1) A	Short Circuit Current (conductor) kA
3x25+3x16/3E + 3x2,5ST+UEL	20204583	5DM2***	6.4	49.1	53.1	3985	1125	0.78	0.26	0.35	139	3.58
3x35+3x16/3E + 3x2,5ST+UEL	20149013	5DM2***	7.6	52.1	56.1	4636	1575	0.554	0.29	0.33	172	5.01
3x50+3x25/3E + 3x2,5ST+UEL		5DM2***	9.1	53.9	57.9	5410	2250	0.386	0.33	0.31	215	7.15
3x70+3x35/3E + 3x2,5ST+UEL	20227836	5DM2***	10.8	57.6	61.6	6200	3150	0.272	0.38	0.3	265	10.01
3x95+3x95/3E + 3x2,5ST+UEL	20204584	5DM2***	12.7	63.6	67.6	7660	4275	0.206	0.43	0.29	319	13.59
3x120+3x70/3E + 3x2,5ST+UEL		5DM2***	14.3	67	71	8991	5400	0.161	0.47	0.28	371	17.16

SUPROMONT (N)3GHSSHCH 12/20 kV

Number of cores x cross section	Part number	MLFB Number	Conductor diameter max. mm	Outer diameter min. mm	Outer diameter max. mm	Weight (approx.) kg/km	Permissible tensile force max. N	Conductor resistance at 20°C max. Ω/km	Nominal operating capacitance μF/km	Inductance nom. mH/km	Current carrying capacity (1) A	Short Circuit Current (conductor) kA
3x25+3x25/3E + 3x2,5ST+UEL		5DM2***	6.4	52.6	56.6	4501	1125	0.78	0.22	0.37	139	3.58
3x35+3x16/3E + 3x2,5ST+UEL	20112422	5DM2242	7.6	53.6	57.6	4850	1575	0.554	0.25	0.35	172	5.01
3x50+3x25/3E + 3x2,5ST+UEL	20060690	5DM2243	9.1	56.8	60.8	5630	2250	0.385	0.28	0.33	215	7.15
3x70+3x35/3E + 3x2,5ST+UEL	20112425	5DM2244	10.8	61	65	6740	3150	0.272	0.32	0.31	265	10.01
3x95+3x50/3E + 3x2,5ST+UEL	20129798	5DM2245	12.7	66	70	8150	4275	0.206	0.36	0.3	319	13.59
3x120+3x70/3E + 3x2,5ST+UEL	20182384	5DM2***	14.3	70.5	74.5	9502	5400	0.161	0.39	0.29	371	17.16
3x150+3x70/3E + 3x2,5ST+UEL	20163741	5DM2***	16.5	76.5	80.5	10900	6750	0.129	0.44	0.28	428	21.45

(1) Nominal current carrying capacity for rubber cables laid on a surface, at 30°C ambient temperature (see also VDE 0298-4, Table 15). For derating-factors see tables in Technical Appendix

PROTOMONT(MT) (N)SHOEU 1 kV

Low Voltage light and flexible rubber cable



Application

Rubber-sheathed flexible cables for mining application, suitable for laying alongside conveyor belts (also for shiftable units), on material handling equipment and for tunneling sites, under heavy mechanical stress, e.g. in cable suspension fittings and as connection between upper and lower cars. The cables can be used indoors as well as outdoors, in explosion-hazard areas, in industry and in agriculture. The cables are water resistant and also suitable for connection of submersible pump units. In other respects the specifications of DIN VDE 0298 part 3 applies.

Global data

Brand	PROTOMONT(MT)
Type designation	(N)SHOEU
Standard	Based on DIN VDE 0250 part 812
Certifications / Approvals	VDE certificate with factory surveillance

Notes on installation

Notes on installation	max. depth 500m
-----------------------	-----------------

Design features

Conductor	Bare electrolytic copper, finely stranded (class 5)
Insulation	PROTOLON, Basic material: EPR, Compound type: Special compound better 3GI3
Core identification	Light gray with black digits
Screen	In case of concentric screen (KON types only): closed layer of copper wire spinning over core assembly
Inner sheath	Basic material: EPR, Compound type: Special compound
Outer sheath	Basic material: Chlorinated rubber, Compound type: Special compound, 5GM5 Colour: yellow

Electrical parameters

Rated voltage	0.6/1 kV (600/1000V)
Max. permissible operating voltage AC	0.7/1.2 kV
Max. permissible operating voltage DC	0.9/1.8 kV
AC test voltage - main cores	3,5 kV (5 Min.)
AC test voltage - control cores	2 kV

Chemical parameters

Performance against fire	IEC 60332-1-2
Resistance to oil	IEC 60811-404
Weather resistance	Unrestricted use outdoors and indoors, resistant to ozone and moisture
Water resistance	EN 50525-2-21

Thermal parameters

Max. operating temperature of the conductor	90 °C
Max. short circuit temperature of the conductor	250 °C
Max. permissible water temperature	40 °C (At higher water temperatures, a shortened cable service life is to be expected)
Ambient temperature for fixed installation	min -40 °C ; max +80 °C
Ambient temperature in fully flexible operation	min -25 °C ; max +60 °C

Mechanical parameters

Max. tensile load on the conductor	15 N/mm ²
Torsional stress +/-	100 °/m
Bending radii min.	Acc. to DIN VDE 0298 part 3
Travel speed	Max. speed on rewinding with drum car: 60 m/min

PROTOMONT(MT) (N)SHOEU 0.6/1 kV

Number of cores x cross section	Part number	MLFB Number	Conductor diameter max. mm	Outer diameter min. mm	Outer diameter max. mm	Weight (approx.) kg/km	Permissible tensile force max. N	Conductor resistance at 20°C max. Ω/km	Nominal operating capacitance μF/km	Inductance nom. mH/km	Current carrying capacity (1) A	Short Circuit Current (conductor) kA
PROTOMONT(MT) (N)SHOEU-O												
1x16	20265363	5DL4***	5.2	9.5	11.1	230	240	1.21	0.44	0.26	99	2.29
1x25	20265364	5DL4***	6.4	11	12.6	335	375	0.78	0.45	0.26	131	3.58
1x35	20265365	5DL4***	7.5	12.3	13.9	435	525	0.554	0.52	0.25	162	5.01
1x50	20265366	5DL4***	9	14.5	16.5	615	750	0.386	0.54	0.25	202	7.15
1x70	20265367	5DL4***	11.1	16.4	18.4	830	1050	0.272	0.61	0.24	250	10.01
1x95	20265369	5DL4***	12.8	18.5	20.5	1060	1425	0.206	0.64	0.24	301	13.59
1x120	20265370	5DL4***	14.5	20.4	22.4	1300	1800	0.161	0.72	0.23	352	17.16
1x150	20265372	5DL4***	16.5	22.8	24.8	1600	2250	0.129	0.72	0.23	404	21.45
1x185	20265373	5DL4***	17.9	24.7	27.7	2020	2775	0.106	0.71	0.23	461	26.46
1x240	20265374	5DL4***	21.2	27.6	30.6	2548	3600	0.08	0.76	0.23	540	34.32
1x300	20265377	5DL4***	23.6	31.6	34.6	3200	4500	0.0641	0.78	0.23	620	42.9
PROTOMONT(MT) (N)SHOEU-O												
2x1,5	20265378	5DL4***	1.6	9.8	11.4	150	45	13.3	0.21	0.33	23	0.18
2x2,5	20265379	5DL4***	2	10.7	12.3	185	75	7.98	0.24	0.32	30	0.31
2x4		5DL4	2.4	11.9	13.5	220	120	4.95	0.27	0.3	41	0.57
PROTOMONT(MT) (N)SHOEU-O												
3x2,5	20265395	5DL4***	2	11.1	12.7	210	113	7.98	0.24	0.32	30	0.31
3x4	20265396	5DL4***	2.4	12.1	13.7	271	180	4.95	0.27	0.3	41	0.57
3x6	20265397	5DL4***	2.9	13.2	14.8	350	270	3.3	0.32	0.29	53	0.86
3x10	20265398	5DL4***	3.9	16.1	18.1	505	450	1.91	0.34	0.28	74	1.43
3x16	20265399	5DL4***	5.2	19	21	775	720	1.21	0.44	0.26	99	2.29
3x25	20265400	5DL4***	6.4	22.9	24.9	1160	1125	0.78	0.45	0.26	131	3.58
3x35	20265401	5DL4***	7.5	24.9	27.9	1550	1575	0.554	0.52	0.25	162	5.01
3x50	20265402	5DL4***	9	29.4	32.4	2180	2250	0.386	0.54	0.25	202	7.15
3x70	20265403	5DL4***	11.1	34.8	37.8	3020	3150	0.272	0.61	0.24	250	10.01
3x95	20265405	5DL4***	12.8	40.9	43.9	3810	4275	0.206	0.64	0.24	301	13.59
3x120	20265406	5DL4***	14.4	44.7	47.7	4970	5400	0.161	0.72	0.23	352	17.16
3x150	20265407	5DL4***	16.1	50	54	6290	6750	0.129	0.72	0.23	404	21.45
3x185	20265408	5DL4***	17.9	54.6	58.6	7470	8325	0.106	0.95	0.22	461	26.46
PROTOMONT(MT) (N)SHOEU-J												
3x1,5	20265409	5DL4***	1.6	10.2	11.8	170	68	13.3	0.21	0.33	23	0.18
3x2,5	20265410	5DL4***	2	11.1	12.7	220	113	7.98	0.24	0.32	30	0.31
3x4	20265411	5DL4***	2.4	12.1	13.7	290	180	4.95	0.27	0.31	41	0.57
3x6	20265412	5DL4***	2.9	13.2	14.8	360	270	3.3	0.32	0.29	53	0.86
PROTOMONT(MT) (N)SHOEU-J												
4x1,5	20265413	5DL4***	1.6	11	12.6	204	90	13.3	0.21	0.33	23	0.18
4x2,5	20265414	5DL4***	2	12	13.6	270	150	7.98	0.24	0.32	30	0.31
4x4	20265415	5DL4***	2.4	13	14.6	338	240	4.95	0.27	0.3	41	0.57
4x6	20265416	5DL4***	2.9	14.9	16.9	450	360	3.3	0.32	0.29	53	0.86
4x10	20265417	5DL4***	3.9	17.4	19.4	690	600	1.91	0.34	0.28	74	1.43
4x16	20265418	5DL4610	5.2	21	23	980	960	1.21	0.44	0.26	99	2.29
4x25	20265419	5DL4***	6.4	24.5	27.5	1490	1500	0.78	0.45	0.26	131	3.58
4x35	20265420	5DL4***	7.5	28.4	31.4	1870	2100	0.554	0.52	0.25	162	5.01

(1) Nominal current carrying capacity for rubber cables laid on a surface, at 30°C ambient temperature (see also VDE 0298-4, Table 15). For derating-factors see tables in Technical Appendix
Halogen-free version with 5GM3 outer sheath available on request

Continued from previous page.

PROTOMONT(MT) (N)SHOEU 0.6/1 kV

Number of cores x cross section	Part number	MLFB Number	Conductor diameter max. mm	Outer diameter min. mm	Outer diameter max. mm	Weight (approx.) kg/km	Permissible tensile force max. N	Conductor resistance at 20°C max. Ω/km	Nominal operating capacitance µF/km	Inductance nom. mH/km	Current carrying capacity (1) A	Short Circuit Current (conductor) kA
4x50	20265421	5DL4***	9	33.6	36.6	2570	3000	0.386	0.54	0.25	202	7.15
4x70	20265423	5DL4***	10.6	39.5	42.5	3920	4200	0.272	0.61	0.24	250	10.01
4x95	20265424	5DL4***	12.8	44.8	47.8	5040	5700	0.206	0.64	0.24	301	13.59
4x120	20265425	5DL4613	14.4	49.8	53.8	6200	7200	0.161	0.72	0.23	352	17.16
4x150		5DL4	16.1	54.9	58.9	7578	9000	0.129	0.72	0.23	404	21.45
PROTOMONT(MT) (N)SHOEU-J												
3x50+3x25/3	20278765	5DL4***	9	29.4	32.4	2350	2250	0.386	0.54	0.25	202	7.15
3x70+3x35/3	20268926	5DL4614	10.6	35.1	38.1	3220	3150	0.272	0.61	0.24	250	10.01
3x95/50	20220195	5DL4***	12.1	44.8	47.8	4400	4275	0.206	0.6	0.24	301	13.59
3x95+3x50/3	20268927	5DL4615	12.8	40.7	43.7	4300	4275	0.206	0.64	0.24	301	13.59
3x120+3x70/3	20268929	5DL4616	14.4	44.5	47.5	5370	5400	0.161	0.72	0.23	352	17.16
3x150+3x70/3	20278766	5DL4***	16.5	51.6	55.6	6950	6750	0.129	0.72	0.23	404	21.45
3x185+3x95/3	20278767	5DL4***	17.9	54.5	58.5	8150	8325	0.106	0.71	0.23	461	26.46
3x240+3x120/3	20278768	5DL4***	20.6	62.2	66.2	10700	10800	0.08	0.76	0.23	540	34.32
3x300+3x150/3	20278769	5DL4***	23.4	70.3	74.3	13300	13500	0.064	0.78	0.23	620	42.9
PROTOMONT(MT) (N)SHOEU-J												
5x1,5	20278770	5DL4***	1.6	11.9	13.5	240	113	13.3	0.21	0.33	23	0.18
5x2,5	20278771	5DL4***	2	12.9	14.5	310	188	7.98	0.24	0.32	30	0.31
5x4	20268918	5DL4605	2.4	14.7	16.7	420	300	4.95	0.27	0.3	41	0.57
5x6	20268919	5DL4606	2.9	16.1	18.1	530	450	3.3	0.32	0.29	53	0.86
5x10	20268772	5DL4	3.9	19	21	795	750	1.91	0.34	0.28	74	1.43
5x16	20268920	5DL4607	5.2	22.8	24.8	1180	1200	1.21	0.44	0.26	99	2.29
5x25	20278773	5DL4***	6.4	28	31	1880	1875	0.78	0.45	0.26	131	3.58
5x35	20278774	5DL4***	7.5	34.5	37.5	2650	2625	0.554	0.46	0.25	162	5.01
PROTOMONT(MT) (N)SHOEU-O Control cables												
12x4	20278807	5DL4***	2.4	20.8	22.8	870	720	4.95	0.27	0.3	41	0.57
12x6	20278808	5DL4***	2.9	23.4	26.4	1150	1080	3.3	0.32	0.29	53	0.86
PROTOMONT(MT) (N)SHOEU-J Control cables												
7x1,5	20278776	5DL4***	1.6	12.9	14.5	300	158	13.3	0.21	0.33	23	0.18
8x1,5		5DL4	1.6	13.8	15.4	325	180	13.3	0.21	0.33	23	0.18
10x1,5		5DL4	1.6	15.5	17.5	400	225	13.3	0.21	0.33	23	0.18
12x1,5	20278777	5DL4***	1.6	15.8	17.8	500	270	13.3	0.21	0.33	23	0.18
14x1,5		5DL4	1.6	16.8	18.8	495	315	13.3	0.21	0.33	23	0.18
18x1,5	20278778	5DL4***	1.6	18.5	20.5	610	405	13.3	0.21	0.33	23	0.18
19x1,5	20278779	5DL4***	1.6	18.9	20.9	650	428	13.3	0.21	0.33	23	0.18
24x1,5	20278780	5DL4***	1.6	20	22	800	540	13.3	0.21	0.33	23	0.18
7x2,5	20278801	5DL4***	2	14.9	16.9	450	263	7.98	0.24	0.32	30	0.31
8x2,5	20278802	5DL4***	2	15.8	17.8	480	300	7.98	0.24	0.32	30	0.31
10x2,5		5DL4	2	16.4	18.4	500	375	7.98	0.24	0.32	30	0.31
12x2,5	20278803	5DL4***	2	18	20	600	450	7.98	0.24	0.32	30	0.31
15x2,5	20278804	5DL4***	2	20.7	22.7	780	563	7.98	0.24	0.32	30	0.31
18x2,5	20278805	5DL4***	2	21.2	23.2	850	675	7.98	0.24	0.32	30	0.31
19x2,5		5DL4	2	22.3	24.3	900	713	7.98	0.24	0.32	30	0.31
24x2,5	20278806	5DL4***	2	22.8	24.8	1070	900	7.98	0.24	0.32	30	0.31

(1) Nominal current carrying capacity for rubber cables laid on a surface, at 30°C ambient temperature (see also VDE 0298-4, Table 15). For derating-factors see tables in Technical Appendix
Halogen-free version with SGM3 outer sheath available on request

Continued from previous page.

PROTOMONT(MT) (N)SHOEU 0.6/1 kV

Number of cores x cross section	Part number	MLFB Number	Conductor diameter max. mm	Outer diameter min. mm	Outer diameter max. mm	Weight (approx.) kg/km	Permissible tensile force max. N	Conductor resistance at 20°C max. Ω/km	Nominal operating capacitance μF/km	Inductance nom. mH/km	Current carrying capacity (1) A	Short Circuit Current (conductor) kA
37x2,5		5DL4	2	29	31	1600	1388	7.98	0.24	0.32	30	0.31
PROTOMONT(MT) (N)SHOEU-J... KON Control cables												
3x0,75/0,75KON			1.1	6.6	7.6	96	34	26	0.27	0.29	8	0.11
18x1,5/1,5KON			1.6	22	24	720	405	13.3	0.21	0.33	23	0.18
4x1,5/1,5KON			1.6	13	14.6	280	90	13.3	0.19	0.35	23	0.18
7x1,5/4KON			1.6	15.5	17.5	360	158	13.3	0.21	0.33	23	0.18
9x1,5/4KON			1.6	17.5	19.5	430	203	13.3	0.21	0.33	23	0.18
12x1,5/4KON			1.6	18	20	517	270	13.3	0.21	0.33	23	0.18
15x1,5/4KON			1.6	21	23	600	338	13.3	0.21	0.33	23	0.18
19x1,5/4KON			1.6	22	24	700	428	13.3	0.21	0.33	23	0.18
7x2,5/2,5KON			2	14	15.6	418	263	7.98	0.24	0.32	30	0.31
12x2,5/2,5KON			2	16	18	630	450	7.98	0.24	0.32	30	0.31

(1) Nominal current carrying capacity for rubber cables laid on a surface, at 30°C ambient temperature (see also VDE 0298-4, Table 15). For derating-factors see tables in Technical Appendix
Halogen-free version with 5GM3 outer sheath available on request

PROTOMONT NSSHOEU .../3E 1 kV

Rubber-sheathed flexible cable with copper core shield

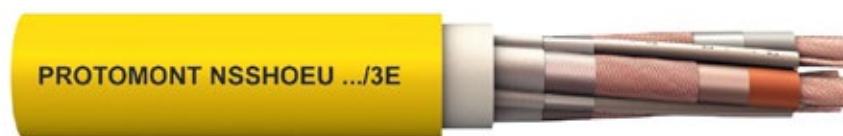

Application

The cables are suitable for fixed installation and flexible operation as power supply cables to motors, distribution boards, pumps, drilling rigs, etc., for underground mining applications, for tunnel building applications, for open-cast mining applications, for use in quarries and similar applications. Permitted for applications according to DIN VDE 0118.

Global data

Brand	PROTOMONT
Type designation	NSSHOEU
Standard	DIN VDE 0250-812
Certifications / Approvals	MA – China (special design) MSHA P-189-3 BAS Bosnia-Herzegovina TR-Certificate EAC-Certificate

Design features

Conductor	Bare electrolytic copper, finely stranded (class 5)
PE-Conductor	Individual-concentric or overall concentric spinning of untinned copper wires
Insulation	PROTOLON, Basic material: EPR, Compound type: 3GI3
Core identification	Up to 5 cores colored, Core colors: Blue, Brown, Black, Grey, Black
Core arrangement	Three, four or five cores laid-up
Inner sheath	Vulcanized rubber inner sheath, Basic material: EPR, Compound type: GM1B
Outer sheath	PROTOFIRM, Basic material: Chlorinated rubber, Compound type: 5GM5, Color: Yellow

Electrical parameters

Rated voltage	$U_0/U = 0,6/1$ kV, also permitted for $U_0/U = 640/1140$ V
Max. permissible operating voltage AC	0.7/1.2 kV
Max. permissible operating voltage DC	0.9/1.8 kV
AC test voltage	3 kV
AC test voltage - control cores	2 kV

Chemical parameters

Performance against fire	IEC 60332-1-2
Resistance to oil	IEC 60811-404
Weather resistance	Unrestricted use outdoors and indoors, resistant to ozone and moisture
Water resistance	DIN EN 50525-2-21

Thermal parameters

Max. operating temperature of the conductor	90 °C
Max. short circuit temperature of the conductor	250 °C
Ambient temperature for fixed installation	min -40 °C ; max +80 °C
Ambient temperature in fully flexible operation	min -25 °C ; max +60 °C

Mechanical parameters

Max. tensile load on the conductor	15 N/mm ²
Bending radii min.	Acc. to DIN VDE 0298 part 3

PROTOMONT NSSHOEU .../3E 0,6/1 kV

Number of cores x cross section	Part number	MLFB Number	Conductor diameter max. mm	Outer diameter min. mm	Outer diameter max. mm	Weight (approx.) kg/km	Permissible tensile force max. N	Conductor resistance at 20°C max. Ω/km	Nominal operating capacitance μF/km	Inductance nom. mH/km	Current carrying capacity (1) A	Short Circuit Current (conductor) kA
PROTOMONT NSSHOEU.../3E												
3x1,5+3x1,5/3E	20005094	5DM4604	1.6	12.5	14.1	280	68	13.3	0.21	0.33	23	0.22
3x2,5+3x2,5/3E	20005095	5DM4605	2	13.6	15.2	340	113	7.98	0.24	0.32	30	0.36
3x4+3x4/3E	20039860	5DM4606	2.4	16.1	18.1	480	180	4.95	0.26	0.31	41	0.57
3x6+3x6/3E	20005096	5DM4607	2.9	17.4	19.4	570	270	3.3	0.3	0.29	53	0.86
3x10+3x10/3E	20005097	5DM4610	4	20.3	22.3	820	450	1.91	0.33	0.28	74	1.43
3x16+3x16/3E	20005098	5DM4612	5	23.9	25.9	1180	720	1.21	0.4	0.27	99	2.29
3x25+3x16/3E	20040501	5DM4613	6.4	27.7	30.7	1640	1125	0.78	0.42	0.26	131	3.58
3x35+3x16/3E	20039858	5DM4614	6.5	30.1	33.1	1990	1575	0.554	0.49	0.25	162	5.01
3x50+3x25/3E	20008752	5DM4615	9	35.9	38.9	2840	2250	0.386	0.51	0.25	202	7.15
3x70+3x35/3E	20007207	5DM4616	10.7	40.6	43.6	3780	3150	0.272	0.6	0.24	250	10.01
3x95+3x50/3E	20005099	5DM4617	12.3	45.5	48.5	4880	4275	0.206	0.61	0.24	301	13.59
3x120+3x70/3E	20015058	5DM4618	14.3	51.9	55.9	6340	5400	0.161	0.7	0.23	352	17.16
3x150+3x70/3E	20006978	5DM4620	16	56.2	60.2	7500	6750	0.129	0.7	0.23	404	21.45
3x185+3x95/3E	20006979	5DM4627	17.7	62.8	66.8	9300	8325	0.106	0.7	0.23	461	26.46
3x240+3x120/3E	20006980	5DM4628	20.3	69.6	73.6	11790	10800	0.08	0.71	0.22	540	34.32
PROTOMONT NSSHOEU.../3E+ST												
3x2,5 + 3x2,5/3E + 3x1,5ST	20005100	5DM4624	2	17.1	19.1	510	113	7.98	0.24	0.32	30	0.36
3x4+3x4/3E + 3x1,5ST	20025110	5DM4626	2.4	17.8	19.8	580	180	4.95	0.26	0.31	41	0.57
3x6+3x6/3E + 3x1,5ST	20005101	5DM4630	2.9	18.4	20.4	640	270	3.3	0.3	0.29	53	0.86
3x10 + 3x10/3E + 3x2,5ST	20005102	5DM4631	4	22.1	24.1	960	450	1.91	0.33	0.28	74	1.43
3x16 + 3x16/3E + 3x2,5ST	20005103	5DM4632	5	23.9	25.9	1250	720	1.21	0.4	0.27	99	2.29
3x25 + 3x16/3E + 3x2,5ST	20005104	5DM4633	6.4	27.7	30.7	1690	1125	0.78	0.42	0.26	131	3.58
3x35 + 3x16/3E + 3x2,5ST	20005105	5DM4634	7.5	30.1	33.1	2040	1575	0.554	0.49	0.25	162	5.01
3x50 + 3x25/3E + 3x2,5ST	20005106	5DM4635	9	35.9	38.9	2890	2250	0.386	0.51	0.25	202	7.15
3x70 + 3x35/3E + 3x2,5ST	20005107	5DM4636	10.7	40.6	43.6	3870	3150	0.272	0.6	0.24	250	10.01
3x95 + 3x50/3E + 3x2,5ST	20005108	5DM4637	12.3	45.5	48.5	4970	4275	0.206	0.61	0.24	301	13.59
3x120 + 3x70/3E + 3x2,5ST	20005109	5DM4638	14.3	51.9	55.9	6430	5400	0.161	0.69	0.23	352	17.16
3x150 + 3x70/3E + 3x2,5ST	20060692	5DM4642	16	56.2	60.2	7330	6750	0.129	0.7	0.23	404	21.45
3x185 + 3x95/3E + 3x2,5ST	20007785	5DM4644	17.7	62.8	66.8	9390	8325	0.106	0.7	0.23	461	26.46
3x240 + 3x120/3E + 3x2,5ST	20100480	5DM4651	20.3	69.6	73.6	11810	10800	0.08	0.71	0.22	540	34.32
PROTOMONT NSSHOEU.../KON												
3x1,5/1,5KON	20161197	5DL2404	1.6	12.4	14	270	68	13.7	0.21	0.33	23	0.22
3x2,5/2,5KON	20004908	5DL2405	1.9	13.7	15.3	350	113	8.21	0.24	0.32	30	0.36
3x4/4KON			2.4	16.1	18.1	450	180	5.09	0.27	0.3	41	0.57
4x6/6KON	20198030	5DL2507	2.9	18.8	20.8	645	360	3.39	0.32	0.29	53	0.86
4x10/10KON	20168272	5DL2508	4.8	23.1	25.1	1010	600	1.95	0.34	0.28	74	1.43
4x16/16KON			5.7	27.1	30.1	1520	960	1.24	0.44	0.26	99	2.29
5x2,5/2,5KON	20004909	5DL2605	1.9	16.4	18.4	490	188	8.21	0.24	0.32	30	0.36
5x4/4KON	20004910	5DL2606	2.4	18.2	20.2	620	300	5.09	0.27	0.3	41	0.57
5x6/6KON	20024743	5DL2607	2.9	21.3	23.3	850	450	3.39	0.32	0.29	53	0.86

(1) Nominal current carrying capacity for rubber cables laid on a surface, at 30°C ambient temperature (see also VDE 0298-4, Table 15). For derating-factors see tables in Technical Appendix

PROTOMONT EMV-FC (N)SSHCOEU 1 kV

Cables for Variable Frequency Converter



Application

The cables are suitable for fixed installation and flexible operation as motor power supply cables for frequency converter controlled drives in the mining industry, on construction sites and similar applications, with heavy mechanical stresses. For laying on material handling equipment (even with continuous movement such as in cable booms or as connection between upper and lower car). Can be applied in water up to 40°C, approximately up to 10 m depth.

Global data

Brand	PROTOMONT EMV-FC
Type designation	(N)SSHCOEU
Standard	Based on DIN VDE 0250 part 812
Certifications / Approvals	MSHA P-189-3 EAC Certificate

Design features

Conductor	Finely stranded copper conductor, tinned (class 5) according to DIN EN 60228
Insulation	PROTOLON, Basic material: EPR, Compound type: 3GI3
Core identification	Natural coloring with black figures
Core arrangement	Three power cores laid up with the protective earth conductors split into three in the outer interstices
Screen	EMC optimized, concentric braid of tinned copper wires
Inner sheath	Vulcanized rubber compound, Basic material: EPR, Compound type: GM1B
Outer sheath	PROTOFIRM, synthetic elastomer compound e.g. CR, Compound type: 5GM5, Color: Yellow

Electrical parameters

Rated voltage	U ₀ /U = 0,6/1 kV, also permitted for U ₀ /U = 640/1140V
Max. permissible operating voltage AC	0.7/1.2 kV
Max. permissible operating voltage DC	0.9/1.8 kV
AC test voltage - main cores	5 kV (5 Min.)

Chemical parameters

Performance against fire	IEC 60332-1-2
Resistance to oil	IEC 60811-404
Weather resistance	Unrestricted use outdoors and indoors, resistant to ozone and moisture

Thermal parameters

Max. operating temperature of the conductor	90 °C
Max. short circuit temperature of the conductor	250 °C
Ambient temperature for fixed installation	min -40 °C ; max +80 °C
Ambient temperature in fully flexible operation	min -25 °C ; max +60 °C

Mechanical parameters

Max. tensile load on the conductor	15 N/mm ²
Torsional stress +/-	25 °/m
Bending radii min.	Acc. to DIN VDE 0298 part 3

PROTOMONT EMV-FC (N)SSHCOEU 0.6/1 kV

Number of cores x cross section	Part number	MLFB Number	Conductor diameter max. mm	Outer diameter min. mm	Outer diameter max. mm	Weight (approx.) kg/km	Permissible tensile force max. N	Conductor resistance at 20°C max. Ω/km	Nominal operating capacitance μF/km	Inductance nom. mH/km	Current carrying capacity (1) A	Short Circuit Current (conductor) kA
3x16+3x2,5	20004904	5DL2108	5.4	24.4	27.4	1190	720	1.24	0.42	0.26	99	2.29
3x25+3x4	20016716	5DL2107	6.3	28.2	31.2	1680	1125	0.795	0.42	0.26	131	3.58
3x35+3x16/3	20004903	5DL2106	7.5	30.5	33.5	2000	1575	0.565	0.49	0.25	162	5.01
3x50+3x25/3	20004902	5DL2105	8.9	36	39	2820	2250	0.393	0.51	0.25	202	7.15
3x70+3x35/3	20004901	5DL2104	10.6	41.2	44.2	3800	3150	0.277	0.59	0.24	250	10.01
3x95+3x50/3	20004900	5DL2103	12.1	45.7	48.7	4760	4275	0.21	0.6	0.24	301	13.59
3x120+3x70/3	20001453	5DL2100	14.1	48.7	52.7	5890	5400	0.164	0.69	0.23	352	17.16
3x150+3x70/3	20004899	5DL2101	16	55.7	59.7	7230	6750	0.132	0.7	0.23	404	21.45
3x185+3x95/3	20004905	5DL2109	17.8	60.4	64.4	8640	8325	0.108	0.71	0.23	461	26.46
3x240+3x120/3	20008903	5DL2102	20.2	68.2	72.2	11100	10800	0.0817	0.73	0.23	540	34.32

(1) Nominal current carrying capacity for rubber cables laid on a surface, at 30°C ambient temperature (see also VDE 0298-4, Table 15). For derating-factors see tables in Technical Appendix





Technical appendix

Type designation	170
Approvals/Standards	172
Colour coding of fibre-optics	175
Installation and handling	176
Reeling cables	176
Underground mining cables	177
Opencast trailing cables	177
Laying instructions for OPTOFLEX (M) cables	178
Centre feeding point	178
Determination of the sag on mast mounting	179
Electrical field control in hybrid sealing ends	180
Stripping semiconductive layers	180
Sealing ends	181
Couplers and cable services	182
Prysmian Group cable services	182
Monitoring	183
PRY-CAM PORTABLE	184
Electrical parameters	186
Voltages	186
Current-carrying capacity	188
De-rating factors	189
Thermal parameters	190
Mechanical parameters	192
Tensile loads	192
Torsional stresses	193
Minimum bending radii	194
Travel speeds	195
Additional tests	196
Chemical parameters	200
Resistance to chemicals	200
Construction characteristics	201
Conductors	201
Insulating and sheathing compounds	204
Shield	205
Electrical field control with cables	206
Core arrangement	206
Support elements	208
Anti-torsion braid	208
Cable drum overview	209
Local standards	209



Type designation

The type designates a group of flexible cables which have the same design features and which are intended for a specific range of technical applications. The type designation is a letter combination in conformity with DIN VDE, which describes the type in coded form.

The German characters “Ö” and “Ü” are transformed into the international “OE” and “UE”, respectively.

Type designation	Description
NSHTOEU	LHD cables for scoop operations: Tough rubber-sheathed 1 kV flexible reeling cable – CORDAFLEX (S), TENAX LK, PROTOMONT (S).
R-(N)TSCGEWÖEU	Medium-voltage reeling cable, 6 to 30 kV – PROTOLON (M).
F-(N)TSCGEWÖEU	Medium-voltage flexible cable, 6 to 30 kV – PROTOLON (M).
NTSCGEWÖEU	Trailing cables, 3 to 35 kV – PROTOLON and TENAX.
(N)SHÖEU	Heavy tough rubber-sheathed flexible cable, 1 kV, for applications in open-cast mining, PROTOMONT (M).
NSSHÖEU	Heavy tough rubber-sheathed flexible cable, 1 kV, for applications in underground mining – PROTOMONT.
NSSHCGEÖEU	Coal cutter cables for underground mining applications – PROTOMONT(Z), PROTOMONT(V) and TENAX CTE.
NTMCGCWÖEU/NTMCWÖEU	Trailing cables of single-sheath design for medium mechanical stresses.
(N)3GHSSYCY	EPR-insulated medium-voltage cables for fixed installation – SUPROMONT.
2YSLCGGÖEU	Data, signal and control cable for mining installations – PROTOMONT MSR Mining.

The type designation can be deciphered as follows:

..C..	Conducting metal casing over the stranded cores or between the inner and outer sheath (shield)
(C)	Additional information about the shield for the conductor cross-sections, e.g.: 12 x 1 (C) which means 1 mm ² individually shielded or 6 x (2 x 1) C which means 2 x 1 mm ² twisted and shielded pairs
..CE..	Conducting metal casing over the insulation of the outer conductors
..CG..	Conducting non-metal casing over the stranded cores or between the inner and outer sheath (shield)
..CGE..	Conducting non-metal casing over the insulation of the outer conductors
F-	Definition of the application: Fixed installation, as supplement to the type designation
FM	Telecommunication lines within the cable
G	High-voltage (HV)
-J	Additional information about the type: With green/yellow marked core
...K...	Rubber cradle separator in the centre of the cables
KON	Concentric protective conductor between the inner and outer sheath or concentric control/monitoring conductor
L...	Lightweight cable design
LWL	Fibre-optic (FO)
(M)	Appendix to trademark, "M = Mining"
N	Design according to the corresponding standard
(N)	Based on standard
-O	Additional information about the type - without green/yellow marked core
Ö*	Oil-resistant outer sheath (according to DIN VDE 0473, Part -2-1, Para. 10) (OE)
R-	Definition of application: Reeling, as appendix to the type designation
(SB)	Appendix to trademark: Trailing operation
..SH..	Heavy tough rubber-sheathed flexible mining-type cable (Rough handling)
...SHT...	1 kV reeling cable
..SL..	Control cable
ST	Control cores within the cables
(ST)	Appendix to trademark to denote water compatibility (submersible pump units)
..T..	Support element
..TM..	Trailing cable for medium mechanical stresses
..TS..	Trailing cables
U	Flame-retardant outer sheath (according to EN 60332-1-2)
ÜL*	Monitoring conductor within the cable (UEL)
(V)	Appendix to trademark for coal cutter cables (V = reinforced)
..W..	Weather resistant
Y	PVC compound
(Z)	Appendix to trademark for coal cutter cables (Z=tensile strength optimized)
2Y...	Definition of the insulation material (2Y = PE)
/3	Protective-earth conductor uniformly distributed in the three interstices
/3E	Protective-earth conductor uniformly distributed over the insulation of the outer conductor
..3G..	Definition of the insulating material (3G = EPR)

*The German characters "Ö" and "Ü" are transformed into the international "OE" and "UE", respectively.

Approvals/Standards

Flexible electric cables for mining applications have to be able to cope with the expected operation and installation conditions. Details are given in the application and installation guidelines. In addition, flexible electric cables for mining applications are described with regard to designs and tests as laid down in national and international standards (design regulations).

Application and installation guidelines

- **DIN VDE 0298, Part 3**
Application of cables and flexible cords in power installations – General information on cables
- **DIN VDE 0298, Part 4**
Application of cables and flexible cords in power installations – Recommended values for current-carrying capacity of cables
- **DIN VDE 0101**
Erection of power installations with rated voltages above 1 kV
- **DIN VDE 0118**
Specification for the erection of electrical installations in underground mines
- **DIN VDE 0168**
Specification for the erection of electrical installations in open-cast mines, quarries and similar works
- **IEC 621**
Electrical installations for outdoor sites under heavy conditions (incl. open-cast mines and quarries)

Design regulations

The summary in the table below shows all the design regulations/standards, according to which the electric cables for mining applications are designed and manufactured.

The following distinctions are made between national and international regulations:

National standard

- **DIN VDE**
DIN = German Standards Institute
VDE = Association of German Electrical Engineers

Germany is one of a few countries which has issued special design regulations for flexible electric cables for mining applications. The 1 kV tough rubber-sheathed flexible reeling cables NSHTOEU, the trailing cables NTS..WOEU and the rubber-sheathed flexible cables NSSHOEU are described and standardised in DIN VDE 0250. This set of standards has found recognition in Europe and in many countries outside Europe and is accepted as or specified as “state of the art”.

No such design regulations exist for the MSR Mining and OPTOFLEX cables. These are Prysmian Group special cables, the design of which is based on existing design regulations or general regulations of DIN VDE.

International standard

For use on an international level, some design features of flexible electric cables for mining applications covered by DIN VDE are also listed or certified.

- **MSHA**
Mine Safety and Health Administration, USA
- **MA China**
Chinese mining approval
- **WUG**
Approval of the Polish Mining Inspectorate, necessary for use of cables in Polish mines
- **BAS certificate**
Approval of the Institute for standardization of Bosnia and Herzegovina
- **EAC certificate**
Safety regulation for LV-cables in Russia, Belarus, Kazakhstan
- **Fire certificate**
Russian Mining approval
- **Gost -R**
Mining approval of Russian Federation for cables > 1 kV
- **Gost -B**
Mining approval of Republic of Belarus for cables > 1 kV
- **Gost -K**
Mining approval of Kazakhstan for cables > 1 kV

Design regulations/standards			
Flexible cables	Type	German standard DIN VDE	Certificates/Approvals
CORDAFLEX(S)	NSHTOEU	DIN VDE 0250-814	MSHA P-189-3, EAC certificate
FELTOFLEX	NTMCW0EU	DIN VDE 0250-813	Fire certificate, Gost -R/-K/-B
OPTOFLEX(M)	-	Based on DIN VDE 0888 and DIN VDE 0168	-
PROTOLON single-core	NTMCGCWOEU	DIN VDE 0250-813	Fire certificate, Gost -R/-K/-B
PROTOLON(M) single-core	(N)TMCGCWOEU	Based on DIN VDE 0250-813	Fire certificate, Gost -R/-K/-B
PROTOLON(M)	F-(N)TSCGEWOEU	Based on DIN VDE 0250-813	Fire certificate, Gost -R/-K/-B
PROTOLON(M)	R-(N)TSCGEWOEU	Based on DIN VDE 0250-813	Fire certificate, Gost -R/-K/-B
PROTOLON(M) with F.O.	R-(N)TSCGEWOEU	Based on DIN VDE 0250-813	Fire certificate, Gost -R/-K/-B
PROTOLON(SB)	NTSCGEWOEU	DIN VDE 0250-813	Gost -R/-K/-B
PROTOLON(SB-SAM)	(N)TSCGEWOEU	Based on DIN VDE 0250-813	Fire certificate, Gost -R/-K/-B
PROTOLON(ST)	NTSCGEWOEU .../3E	DIN VDE 0250-813	Fire certificate, Gost -R/-K/-B
PROTOLON(ST)	NTSCGEWOEU	DIN VDE 0250-813	Fire certificate, Gost -R/-K/-B
PROTOMONT	NSSH0EU	DIN VDE 0250-812	MA - China, MSHA P-189-3, EAC certificate
PROTOMONT	NSHX0EU	Based on DIN VDE 0250-812	-
PROTOMONT	NSSH0EU .../3E	DIN VDE 0250-812	MA-China, MSHA P-189-3, BAS certificate, EAC certificate
PROTOMONT festoon	NTSKCGECWOEU	DIN VDE 0250-813	MA - China, WUG - Poland, BAS certificate, Fire certificate, Gost -R/-B/-K
PROTOMONT EMV-FC	(N)SSHCOEU	Based on DIN VDE 0250-812	MSHA P-189-3, EAC certificate
PROTOMONT(M+)	(N)SH0EU	Based on DIN VDE 0250-812	-
PROTOMONT(MSR)	ZYSLGCG0EU	Based on DIN VDE 0250-1	EAC certificate
PROTOMONT(MT)	(N)SH0EU	Based on DIN VDE 0250-812	VDE certificate with factory surveillance
PROTOMONT(V)	NSSHCGE0EU	DIN VDE 0250-812	MA - China, MSHA P-07-KA140034-MSHA, BAS-certificate, EAC certificate
PROTOMONT(V)	NTSKCGECWOEU	DIN VDE 0250-813	MA - China, MSHA P-07-KA140034-MSHA, WUG - Poland (6 kV only), Fire certificate, Gost -R/-K/-B
PROTOMONT(VO)	(N)TSKCGEWOEU	Based on DIN VDE 0250-813	MA - China, Gost -R/-K/-B
PROTOMONT(S)	(N)SSHCGE0EU	Based on DIN VDE 0250-812	MA - China, EAC certificate
PROTOMONT(Z)	NSSHKCGE0EU	DIN VDE 0250-812	MA - China, MSHA P-07-KA140034-MSHA, BAS certificate, EAC certificate
PROTOMONT TBM	(N)TSCGECWOEU	Based on DIN VDE 0250-813	Fire certificate, Gost -R/-K/-B
PROTOMONT TBM	(N)TSCGECWHX0EU	Based on DIN VDE 0250-813	Fire certificate, Gost -R/-K/-B
SUPROMONT	(N)3GHSSYCY	Based on DIN VDE 0250-605	VDE certificate of conformity
SUPROMONT	(N)3GHSSHCH	Based on DIN VDE 0250-605	VDE certificate of conformity
TENAX-CTE	NSSHKCGE0EU	DIN VDE 0250-812	EAC certificate
TENAX-HTT	(N)TSCGEWOEU	Based on DIN VDE 0250-813	Fire certificate, Gost -R/-K/-B
TENAX-LK	NTSKCGEWOEU	DIN VDE 0250-812	EAC certificate
TENAX-LUMEN	(N)TSCGEH3S	Based on DIN VDE 0250-813	-
TENAX-SAS	NTSCGEWOEU	DIN VDE 0250-813	Fire certificate, Gost -R/-K/-B



Colour coding of fibre-optics

	No. of fibres	Fibre colours	Buffering tube colours
Monomode design E9/125 µm	6 x 1E9/125	OG / BN / WH / RD / BK / YE	6 x nf
	6 x 2E9/125	OG-PK / BN-PK / WH-PK / RD-PK / BK-PK / YE -PK	6 x nf
	6 x 3E9/125	BU / OG / GN	YE / BK / nf / nf / nf / nf
Graded-index fibre design G50/125 µm	6 x 1G50/125	OG / GN / BN / WH / RD / BK	6 x nf
	6 x 2G50/125	OG-PK / GN -PK / BN-PK / WH-PK / RD-PK / BK-PK	6 x nf
	6 x 3G50/125	BU / OG / GN	GN / BK / nf / nf / nf / nf
Graded-index fibre design G62.5/125 µm	6 x 1G62.5/125	BU / OG / BN / WH / RD / BK	6 x nf
	6 x 2G62.5/125	BU -PK / OG-PK / BN-PK / WH-PK / RD-PK / BK-PK	6 x nf
	6 x 3G62.5/125	BU / OG / GN	BU / BK / nf / nf / nf / nf

Bold-faced colour codings are indices relative to the fibre type.

Colour code												
BU	OG	GN	BN	WH	RD	BK	YE	VI	PK	TQ	CY	nf
Blue	Orange	Green	Brown	White	Red	Black	Yellow	Violet	Pink	Turquoise	Cyan	natural colouring

Installation and handling

Reeling cables

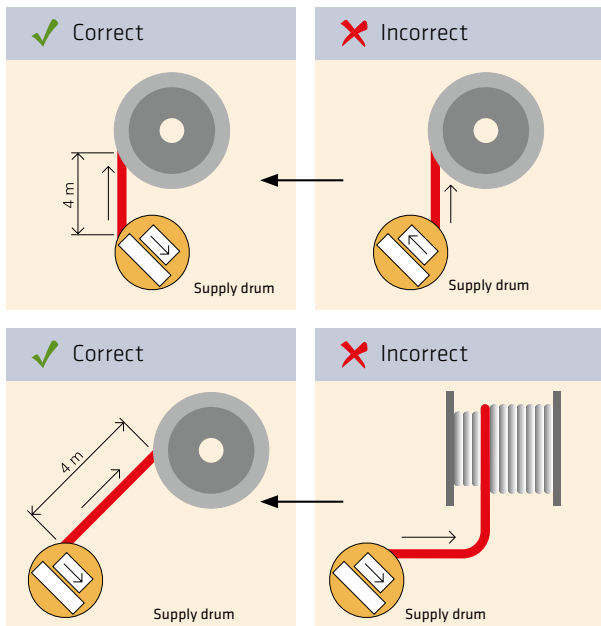

Winding from supply drum to the operation drum:

- Supply drum in parallel position to the operation drum
- Min. 4 m between two bendings
- Use operation guiding system to wind the cable on the operation drum
- No S-bendings
- No torsion
- Watch the max. tensile load during the rewinding process

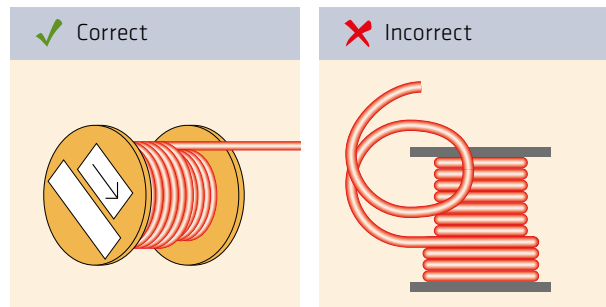
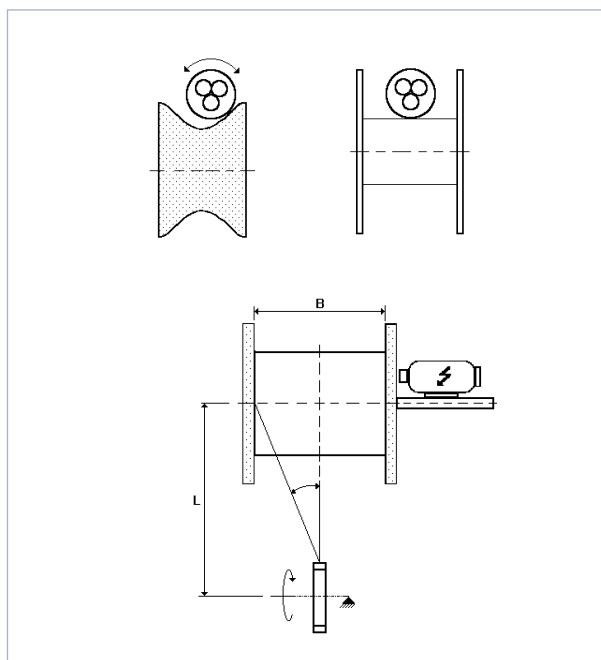

Note! Never draw the cable over the flange “head over heels”, because this would cause 360° torsion with each loop.

Start winding on cylindrical reels:

- Power cables
 - first loop (winding) at the left flange
- Control cables
 - first loop (winding) at the right flange

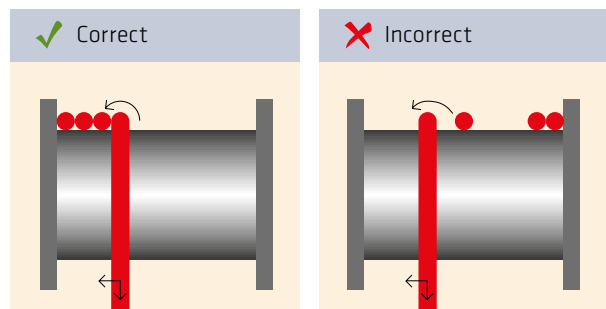

During operation

- Tensile load – the max. tensile load is given in the corresponding cable data sheet.
- Bending radii – see table below
- Torsional stress – may be caused by transversal moving in the sheaves or by misaligned guiding systems.

Minimum permissible bending radii (for cable $D_L > 20$ mm)	
Fixed installation	$6 \times D_L$
Fully flexible operation	$10 \times D_L$
Entry e.g. at a centre feeding point	$10 \times D_L$
Forced guidance with reeling operation	$12 \times D_L$
Forced guidance with sheaves	$15 \times D_L$

D_L = cable diameter

Opencast trailing cables

Transportation on site

- Either on the original supply drum or by using a transportation container or on a truck platform
- By using a transport container or the truck platform the cable has to be inserted in “8-shapes”

Cable handling on site

- Pulling out of the transportation container and laying on the ground only manually
- Do not drag the cable over the flange when removing from the drum, because this would cause 360° torsion with each loop
- Do not undercut the minimum bending radius
- No torsion
- Do not kink the cable
- Watch the max. tensile load during the whole installation process
- **Note!** Never draw or drag the cable by using the excavator or hoist equipment

During operation

- Use a cable strain relief to fix the cable at the top of the pole
- Use a pulling bow for moving the cable over the ground
- Do not exceed the maximum tensile forces during pulling the cable over ground

Guidelines for a long lifetime of trailing cables

- Periodical control of the cable with respect to damages, squeezing and crushing
- Damages in the outer sheath should be repaired immediately by using a self-vulcanizing tape in order to avoid moisture penetration into the cable
- Avoid high tensile forces to the cable
- Avoid kinking and twisting the cable

Underground mining cables

Transportation to the underground face

- Either on the original supply drum or by using a transportation container
- By using a transport container the cable has to be inserted in “8-shapes”

Cable handling in the longwall face

- Pulling out of the transportation container and taking into the face only manually
- Don't undercut the minimum bending radius
- No torsion
- Don't kink the cable
- Watch the max. tensile load during the whole installation process
- **Note!** Never draw or drag the cable by using the face conveyor or a hoist



Integration of PROTOMONT (V); (VO) and TENAX CTE into the cable chain (cable handler)

- The cable should have high latitude (mobility) in the chain along the complete length
- The cable should lay uncongested in the chain: means no clamping along the length. 3 mm to 5 mm distance between cable and chain is required
- Don't use any cable straps to fix the cable at the chain
- The cable should have only one fixing point in the chain; directly behind the machine

Guidelines for a long lifetime of chain cables

- Tensile force monitoring or shear pin (bolt) should be used to protect the cable against exceeding tensile forces
- The spill plate should be cleaned periodically from coal and rocks in order to guarantee a free trailing of the cable and the cable handler (cable chain)
- Periodical control of the cable with respect to damages, squeezing and crushing
- Damages in the outer sheath should be repaired immediately by using a self-vulcanizing tape in order to avoid moisture penetration into the cable.

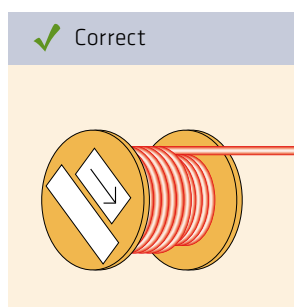

Laying instructions for OPTOFLEX (M) cables

OPTOFLEX(M) fiber-optic cables are designed for the severe operating conditions prevailing in mining applications. However, maintenance of the desired transmission characteristics is also dependent on a number of factors, which must be taken into account for laying and installation.

Tensile load

The permissible tensile load of 2000 N may not be exceeded during laying. Special care must be taken, where the cable is supplied in long supply lengths and is pulled off axially from the supply drum. The thereby occurring acceleration forces of the drum must under no circumstances be transmitted through the cable.

Bending radius

Laying of the cable must be carried out in such a manner that the minimum bending radius of 50 mm is maintained under all circumstances. In particular, on entry into equipment and switchgear cubicles precautions must be taken to ensure that kinking of the cable does not occur.

Pinching stress

Attention must be paid to ensure that, when the cable is fastened by means of cable clips, cable binding bands, etc., the permissible transverse pressure forces are not exceeded. In the course of appropriate pinching stress tests a limit value of 300 N/cm was determined, up to which value no increase in attenuation was detected.

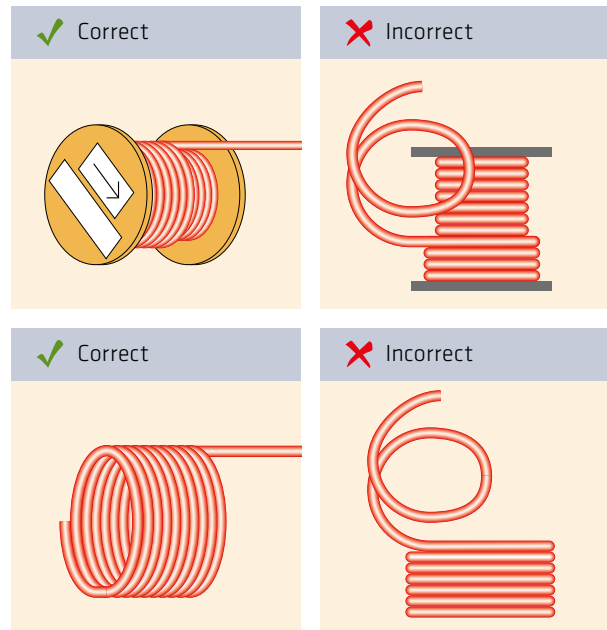

Torsional stress

On laying OPTOFLEX cables, care must be taken to ensure that impermissible torsional stresses are not applied to the cables. Under no circumstances may the cable be drawn from the ring or the drum "head over heels", since otherwise a torsion through 360° would occur for each turn of the cable.

Centre feeding point

In many installations, e.g. bunkering equipment, the power infeed point is located at the centre of the guideway. The flexible electric reeling cables are normally connected through under-floor infeeds (see picture "Underfloor infeeds").

In order to achieve effective strain relief in conjunction with cable-wear minimising deflection from the infeed point, we recommend the use of underfloor infeeds (see figure). It is important that the specified bending radius is maintained and that the cable is fastened at the compensation cylinder by means of a clip, which, however, should be attached only after the 2nd winding.

Minimum permissible bending radius as a function of the cable diameter:

Flexible cables	Rated voltage U_o/U	d in mm / R_{min}			
		Up to 8	Above 8 to 12	Above 12 to 20	Above 20
CORDAFLEX / TENAX	Up to 0.6/1 kV	3 x d	4 x d	5 x d	5 x d
		10 x d			
PROTOLON / TENAX	Above 0.6/1 kV	10 x d			

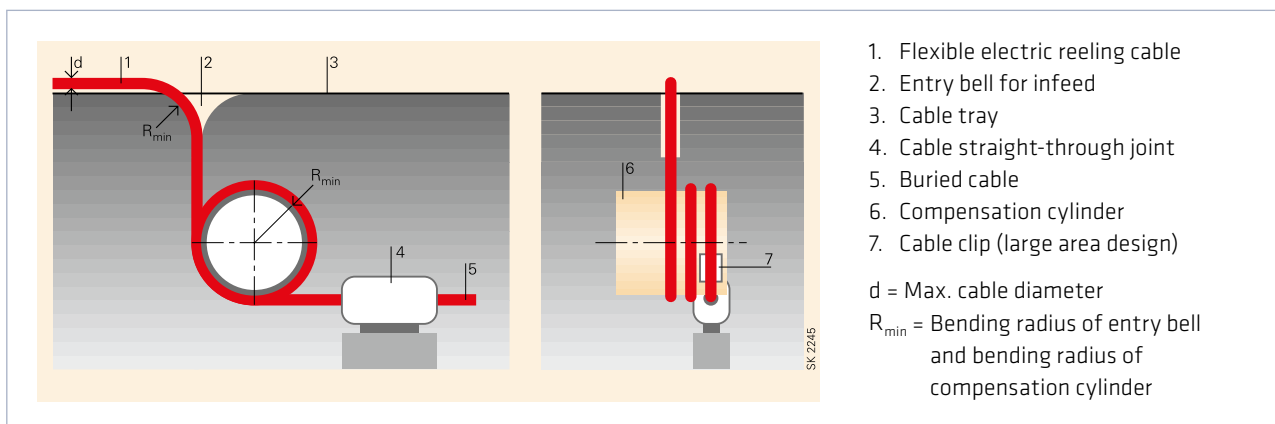

1. Flexible electric reeling cable
2. Entry bell for infeed
3. Cable tray
4. Cable straight-through joint
5. Buried cable
6. Compensation cylinder
7. Cable clip (large area design)

d = Max. cable diameter
 R_{min} = Bending radius of entry bell and bending radius of compensation cylinder

Determination of the sag on mast mounting

Both in open-cast mines and also in other industrial applications (e.g. construction sites) flexible cables must sometimes be suspended above guideways (see picture below).

In such cases maintenance of the minimum permissible bending radius at the cable suspension point and of the maximum permissible tensile force for each type of cable design must be observed.

For the correct cable installation, the following three diagrams are provided, which depict the sag as a function of the span. In case of PROTOLON trailing cables for the main voltage levels of 3.6/6 kV, 6/10 kV and 8.75/15 kV, the sag should be taken from the diagram for the desired span. A maximum permissible tensile load of 15 N/mm² has been incorporated as a parameter in the diagram.

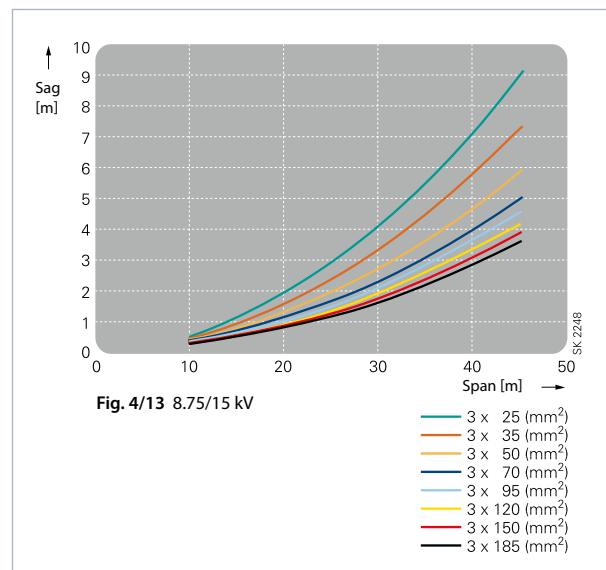
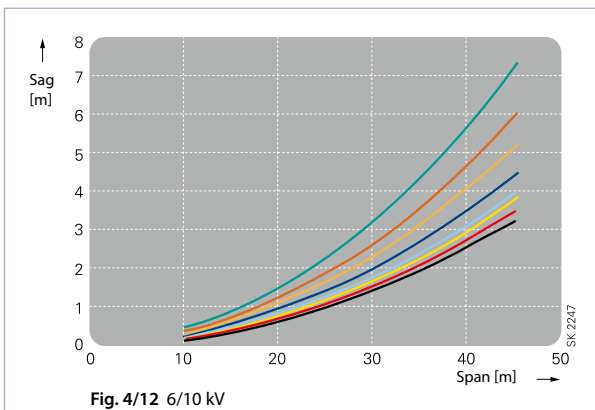
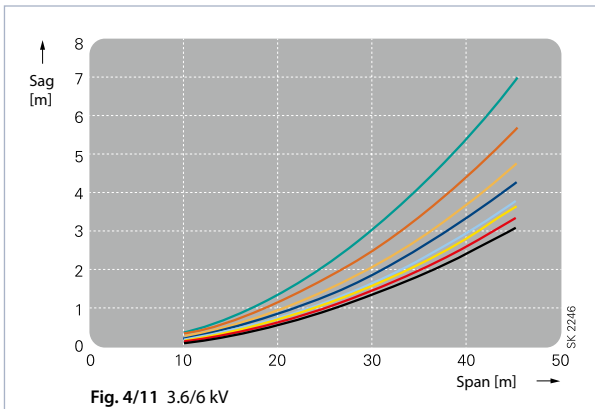

Underfloor infeeds



Cable suspended above guideways

Electrical field control in hybrid sealing ends

In order to control the electrical field in medium-voltage cables, the use of an inner semiconductive layer is required, which is applied as a smoothing layer directly on the metallic conductor, the insulation covering and the outer semiconductive layer, which is in contact with the protective-earth conductor. In cable systems the sealing ends are assigned the task of containing the electrical field.

Our hybrid sealing ends, which are specially designed for the operational requirements of flexible electric cables for mining applications, operate on the principle of resistive electrical field control, which achieves potential reduction as a result of the ohmic and capacitive characteristics and thus reduces the electrical field strength to an acceptable level over the length of the serving.

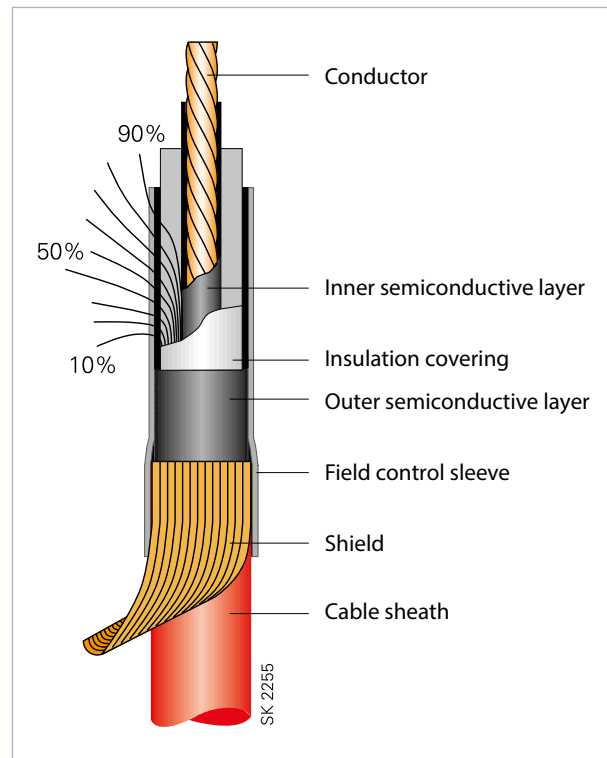

Stripping semiconductive layers

In the case of PROTOLON and TENAX with bright (light grey) core insulation, the semiconductive rubber layer over the insulation must be stripped carefully in order to mount the cable sealing end. To this end, the stripping point is marked and a circular indentation is made on the cable by slightly pressing a pipe cutter (picture 1).

Make a notch at the stripping point by means of a triangular-section file while bending the cable slightly. It is important hereby that the bright core insulation should not be damaged (picture 2).

Carefully cut through approx. 2/3 of the semiconductive rubber layer using between two to four longitudinal cuts. Warm the core end slightly using a propane gas flame and lift off the semiconductive layer at the end of the core using a wood rasp. Strip off the semiconductive layer in strips and remove it completely (picture 3).

Note! Problems can arise when stripping off the semiconductive layer due to tearing out of part of the insulation layer. In such case, the stripping procedure must be started from the opposite side. Use a smooth file, where necessary.

Stripping semiconductive cold-strippable layers (orange insulation color)

The distinguishing feature of these cables is the cold-strippable semiconductive layer. In this case heating by means of a propane gas flame can be omitted completely. The work sequence should otherwise be carried out as described above.



Sealing ends

Sealing ends form the termination point of a medium voltage cable and serve as a connection to the electrical equipment (e.g. switchgears etc.).

Sealing ends cover the following objectives:

- Connection of the conductor
- Sealing of the cable end against ambient influences (e.g. ingress of water)
- Controlled decrement of the electrical field strength
- Insulation from earthed parts

For the complete range of PROTOLON, PROTOMONT and TENAX medium voltage mining cables Prysmian Group offers:

- Sealing end material sets for self-installation on site
- Termination in the factory according to customer specification

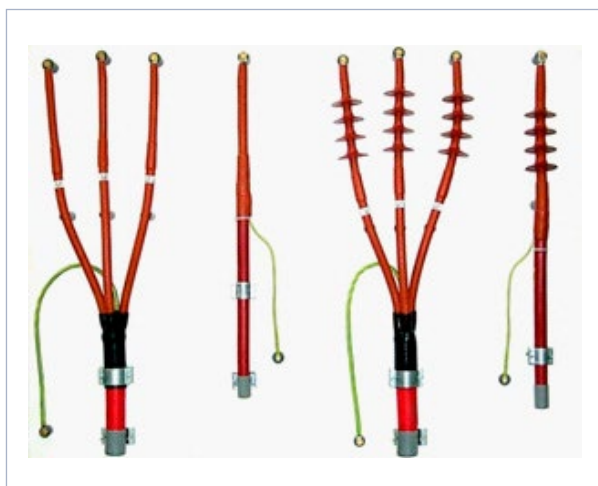
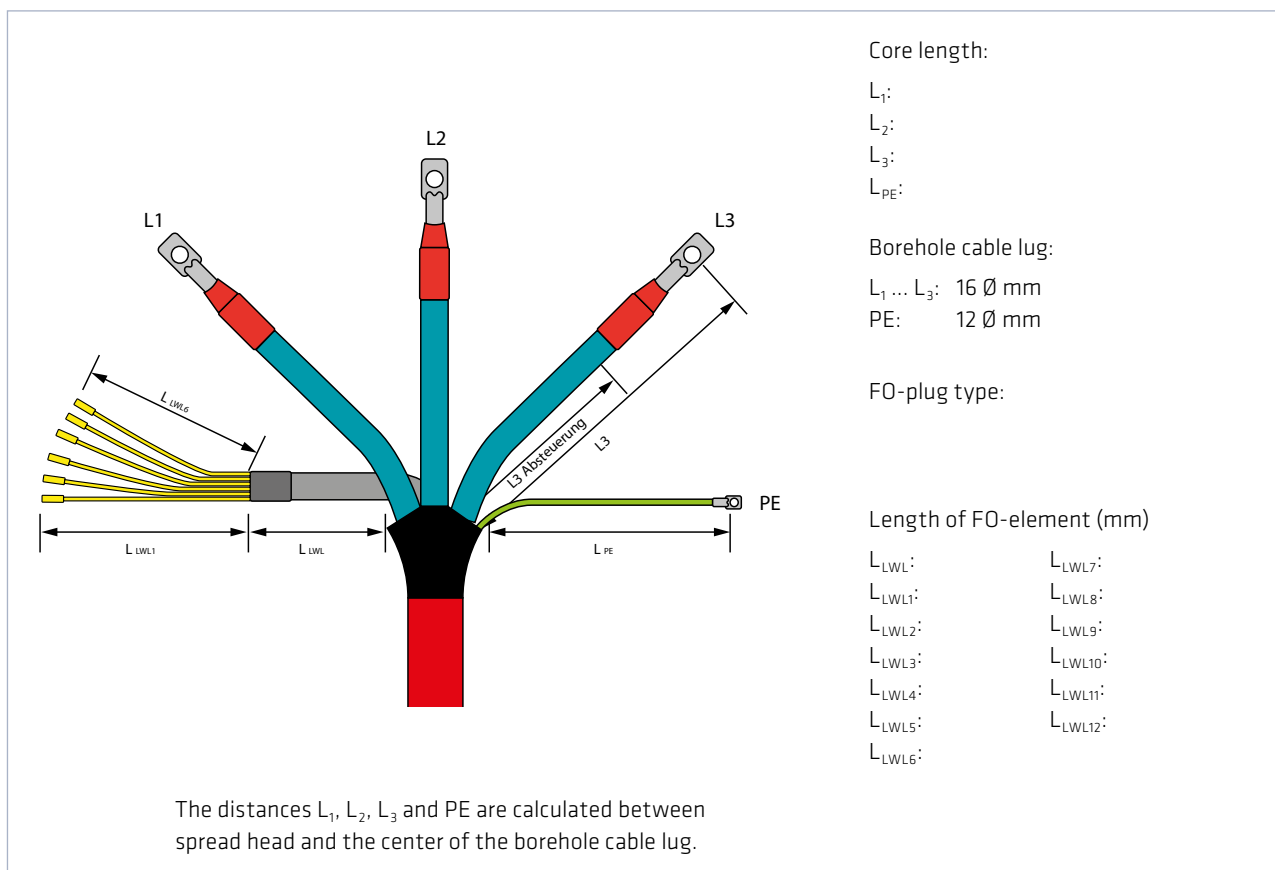

Special sealing end termination for connection box.

Monitoring

Prysmian Group mining cables are designed for all possibilities of monitoring the cable during operation. Different installation standards in the countries require different levels of monitoring safety.

Below there are two monitoring possibilities using devices such as:

- Loop monitor
- Monitor/earth monitoring device
- Insulation monitor
- High-voltage monitor

All Prysmian Group mining cables may be used with the mentioned monitoring systems.

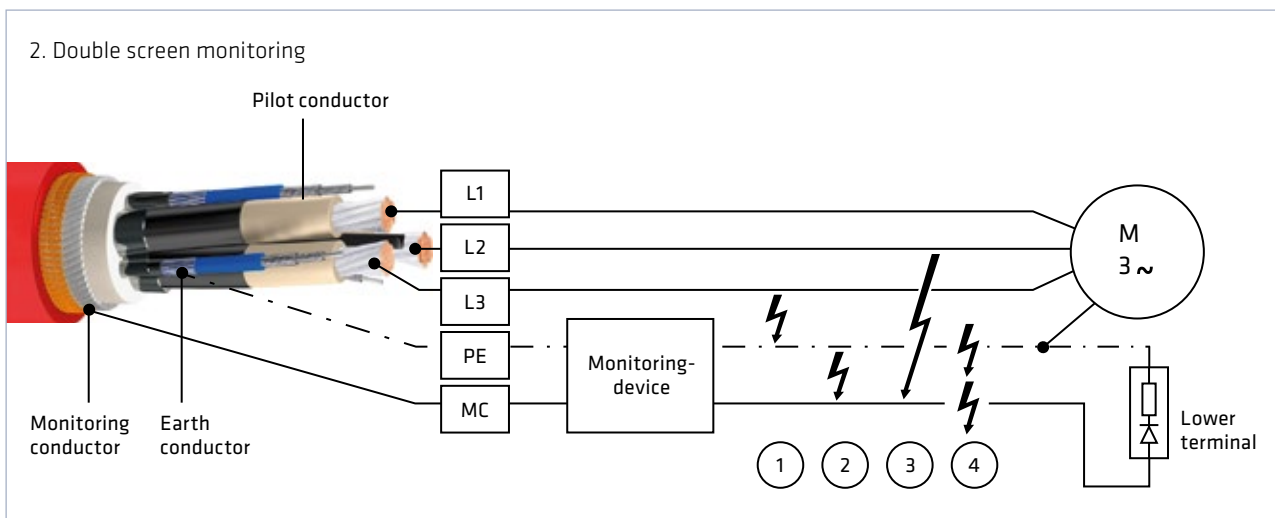
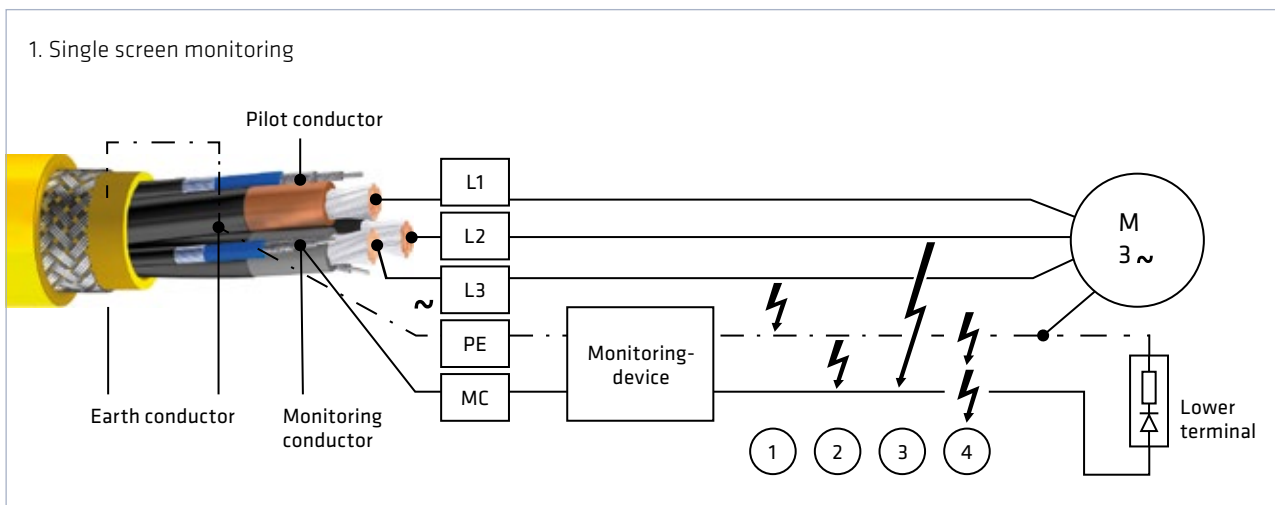

- ① = short circuit phase/protective earth conductor
- ② = short circuit protective earth conductor/monitoring conductor
- ③ = short circuit phase/monitoring conductor
- ④ = break of protective earth or monitoring conductor

PRY-CAM PORTABLE



- Portable, wireless and online partial discharge (pd) measurement

PRY-CAM PORTABLE is an integrated portable instrument for the automatic acquisition, processing and classification of pulse signals generated by PD phenomena occurring in insulating materials of medium and high-voltage electrical systems and equipment, such as transformers, electrical machines, cables systems and switchgear.

PRY-CAM PORTABLE allows you to perform accurate diagnostic measurements and continuous monitoring, without the worry of service interruptions.

Data management

Every single PD measurement can be saved alongside other useful details, such as pictures, recorded messages, GPS coordinates, notes and tags.

Three operating modes

Seamlessly move between basic, advanced and premium operating modes depending on your information needs and PD expertise. You can temporarily upgrade from BASIC to ADVANCED or PREMIUM modes for more detailed diagnosis as and when you need it.

BASIC - Free use

Your PRY-CAM PORTABLE can be used as a reliable PD surveyor with traffic light and simplified PD pattern (recommended for MV).

ADVANCED- Pay-per-use

Provides you with the PD pattern for simple diagnosis only (recommended for MV + HV).

PREMIUM - Pay-per-use





Provides you with the complete PD pattern, including waveforms and frequency spectrum, for any single PD pulse (recommended for MV + HV).

PRY-CAM PORTABLE - technical specifications

Sensor type	Electromagnetic, based on a patented Ultra Wide Band antenna, also providing AC synch signal	Interfaces	Wireless 802.11 b/g (WiFi)
Bandwidth	100 MHz	AC external synch	Wireless RF interface @ 868 MHz
PD sensitivity	Down to 1 pC	Internal battery	Li-Po 7.4 V, 2200 mAh. Autonomy approx. 6 hours
Synch frequency	From 10 Hz to 1 kHz	Working temperature	From -25 °C to 70 °C
Sampling frequency	200 MS/s	Weight	400 g
Processing	Real-time filtering capabilities, ultra-precise time stamping (*10 ns)	Dimensions	L160 x W120 x H130 mm
		Case	Rugged ABS plastic with IP67 protection rating



Key features

-  Portable
-  Wireless technology
-  Ultra-wide bandwidth differential field sensor with 0.5 pC sensitivity
-  Accurate acquisition of PD and AC sync
-  No galvanic connection for maximum safety

Why PRY-CAM PORTABLE is better for your business

- 100 % of critical defects detected on HV and MV
- Up to 80 % of faults avoided
- 70 % measurement time saved against traditional technologies
- Up to 5x higher sensitivity on small defects

PRY-CAM Backpack kit

Includes one backpack, one telescopic stick, one tripod, one strap and one car charger, giving you everything you need, even in the most difficult situations.



PRY-CAM CLOUD

PRY-CAM CLOUD is the ideal way to empower your business by effectively managing your data. Your measurements, collected by PRY-CAM devices, can be safely stored and protected on the PRY-CAM CLOUD, and used for advanced post processing and learning. So you can easily share measurements, test details and knowledge within your company.



Electrical parameters

Voltages

For the rated, operating and test voltages of cables, the definitions given in DIN VDE 0298, Part 3, apply. Some of these are mentioned in the following pages.

AC = Alternating Current
DC = Direct Current

Rated voltage

The rated voltage of an insulated electric cable is the voltage which is used as the basis for the design and the testing of the cable with regard to its electrical characteristics.

The rated voltage is expressed by the two values of power frequency voltage U_0/U in V.

U_0 = rms value between one conductor and "Earth"
 U = rms value between two conductors of a multi-core cable or of a system of single-core cables

In a system with AC voltage, the rated voltage of a cable must be at least equal to the rated voltage of the system for which it is used. This requirement applies both to the value U_0 and the value U .

In a system with DC voltage, its rated voltage must not be more than 1.5 times the value of the rated voltage of the cable.

Operating voltage

The operating voltage is the voltage applied between the conductors and earth of a power installation with respect to time and place with trouble-free operation.

- Cables with a rated voltage U_0/U up to 0.6/1 kV
These cables are suitable for use in three-phase AC, single-phase AC and DC installations, the maximum continuously permissible operating voltage of which does not exceed the rated voltage of the cables by more than
 - 10% for cables with a rated voltage U_0/U up to and including 450/750 V
 - 20% for cables with a rated voltage $U_0/U = 0.6/1$ kV
- Cables with a rated voltage U_0/U greater than 0.6/1 kV
These cables are suitable for use in three-phase and single-phase AC installations, the maximum operating voltage of which does not exceed the rated voltage of the cable by more than 20%
- Cables in DC installations
If the cables are used in DC installations, the continuously permissible DC operating voltage between the conductors must not exceed 1.5 times the value of the permissible AC operating voltage. In single-phase earthed DC installations this value should be multiplied by a factor of 0.5.

Test voltage

Regarding the test voltage of flexible cables, the values given in the corresponding parts of DIN VDE 0250 apply. If the relevant shield is missing, as for example with CORDAFLEX and PROTOMONT cables, "core against core" is tested in appropriate combinations. The values are to be regarded as AC test voltages (unless stated otherwise) for single-phase testing, i.e. the AC test voltage is applied between the core and the corresponding shielding (e.g. semiconductive layer, earth conductor, shield). Telecommunication cores (pairs) and other shielded pairs (e.g. (2x1)C) are tested "core against core" and "core against shield" whereby the test voltages are correspondingly different. With single-core cables without shielding, the corresponding opposite pole is a water bath. See table page 187.

Short-circuit current-carrying capacity

Permissible short-circuit current at max. permissible short-circuit temperatures of the conductor surface and for a fault duration $t_{kr} = 1$ s

Cross-section mm ²	1	1.5	2.5	4	6	10	16	25	35
Short-circuit current (kA)	0.143	0.215	0.358	0.572	0.858	1.43	2.29	3.58	5.01

Cross-section mm ²	50	70	95	120	150	185	240	300	400
Short-circuit current (kA)	7.15	10.01	13.6	17.16	21.45	26.46	34.32	42.9	71.5

The short-circuit current-carrying capacity I_{thz} for a short-circuit duration t_k deviating from $t_{kr} = 1$ s, is:

$$I_{thz} = I_{thr} \cdot \sqrt{\frac{t_{kr}}{t_k}}$$

Voltage drop

$$\Delta U = \sqrt{3} \times I_b \times l \times (R'_{w20} \times \cos\Phi + X'_L \times \sin\Phi)$$

For deviating conductor temperatures (e.g. 90 °C instead of 20 °C) the effective resistance R'_{w} has to be converted:

$$R'_{w90} = R'_{w20} (1 + (0.004 \times 70k))$$

For the practical use a more easier calculation may be sufficient:

$$\Delta U = \sqrt{3} \times I_b \times l \times R'_{w\Theta} \times \cos\Phi$$

I_b = load current [A]

l = cable length [km]

R'_{w20} = effective resistance per unit length and 20 °C [Ω /km]

X'_L = Reactance per unit length [Ω /km]

Φ = phase-angle

Test voltage of flexible cables

Rated voltage	Max. permissible operating voltage			Test voltage applied to the complete cable				
	In AC systems	In DC systems		Power cores		Control cores	Pilot cores	Tele-communication cores
		unearthed	single-phase earthed	AC	DC			
U ₀ /U	U ₀ /U	U kV	U kV	kV	kV	kV	kV	kV
250/250 V	275/275 V	0.412	-	1.5	3.75	-	-	-
300/500 V	318/550 V	0.825	0.413	2	5	-	-	-
450/750 V	476/825 V	1.238	0.619	2.5	6.25	-	-	-
0.6/1 kV	0.7/1.2 kV	1.8	0.9	2.5	6.25	2		
1.8/3 kV	2.1/3.6 kV	5.4	2.7	6	15	2	2	1
3.6/6 kV	4.2/7.2 kV	10.8	5.4	11	27.5	2	2	1
6/10 kV	6.9/12 kV	18	8	17	42.5	2	2	1
8.7/15 kV	10.4/18 kV	27	14	24	60.0	2	2	1
12/20 kV	13.9/24 kV	36	18	29	72.5	2	2	1
14/25 kV	17.3/30 kV	45	3	36	90.0	2	2	1
18/30 kV	20.8/36 kV	54	27	43	107.5	2	2	1
20/35 kV	24.3/42 kV	63	32	50	125	2	2	1

Current-carrying capacity

If, after all selection criteria have been taken into account, the type of flexible electric cable to be used for mining applications has been decided on, the necessary cross-section of the conductor can be determined either from the current to be transmitted or from the power.

Installation conditions (stretched laying, suspended freely in air, reeled), variations in ambient temperature, grouping, type of operation (continuous duty, intermittent periodic duty) and the use of multi-core cables are to be taken into account.

The table below is valid for continuous duty at 30 °C ambient temperature and three loaded cores.

Current-carrying capacity										
Cross-section mm ²	Stretched laying		Suspended freely in air	Reeled in						
	A	A		1 layer	2 layers	3 layers*	4 layers	5 layers	6 layers	7 layers
	Factor 1	Factor 1.36	1.05	0.8	0.61	0.49	0.42	0.38	0.27	0.22
Rubber-insulated up to 10 kV: CORDAFLEX, FELTOFLEX, PROTOLOX, PROTOMONT, SUPROMONT, TENAX										
1	18	24	19	14	11	9	8	7	5	4
1.5	23	31	24	18	14	11	10	9	6	5
2.5	30	41	32	24	18	15	13	11	8	7
4	41	56	43	33	25	20	17	16	11	9
6	53	72	56	42	32	26	22	20	14	12
10	74	101	78	59	45	36	31	28	20	16
16	99	135	104	79	60	49	42	38	27	22
25	131	178	138	105	80	64	55	50	35	29
35	162	220	170	130	99	79	68	62	44	36
50	202	275	212	162	123	99	85	78	55	44
70	250	340	263	200	153	123	105	95	68	55
95	301	409	316	241	184	147	126	114	81	66
120	352	479	370	282	215	172	148	134	95	77
150	404	549	424	323	246	198	170	154	109	89
185	461	627	484	369	281	226	194	175	124	101
240	540	734	567	432	329	265	227	205	146	119
300	620	843	651	496	378	304	260	236	167	136
Rubber-insulated from 15 kV: FELTOFLEX, PROTOLOX, PROTOMONT, SUPROMONT, TENAX										
16	105	143	-	84	64	51	44	40	28	23
25	139	189	-	111	85	68	58	53	38	31
35	172	234	-	138	105	84	72	65	46	38
50	215	292	-	172	131	105	90	82	58	47
70	265	360	-	212	162	130	111	101	72	58
95	319	434	-	255	195	156	134	121	86	70
120	371	505	-	297	226	182	156	141	100	82
150	428	582	-	342	261	210	180	163	116	94
185	488	664	-	390	298	239	205	185	132	107
240	574	781	-	459	350	281	241	218	155	126
300	660	889	-	528	403	323	277	251	178	145
PE-insulated: MSR-mining										
2 x 2 x 1	12									
5 x 2 x 1	8.5									
10 x 2 x 1	6.5									
20 x 2 x 1	5									

*The reduction factor is also valid for flat reeling cables (spirally).

De-rating factors

The de-rating factors take into account the installation and operating conditions, such as temperature, grouping, intermittent periodic duty and the number of simultaneously loaded cores. They are to be used for determining the current-carrying capacity in accordance with the table on page 188.

De-rating factors for varying ambient temperatures							
Ambient temperature °C							
10	15	20	25	30	35	40	45
1.15	1.12	1.08	1.04	1.0	0.96	0.91	0.87

Ambient temperature °C							
50	55	60	65	70	75	80	85
0.82	0.76	0.71	0.65	0.58	0.50	0.41	0.29

De-rating factors for grouping																
Arrangement		Number of multi-core cables or number of single or three-phase circuits made up of single-core cables (2 or 3 loaded conductors)														
		1	2	3	4	5	6	7	8	9	10	12	14	16	18	20
Bunched directly at the wall, the floor, in conduit or ducting, on or in the wall		1.0	0.8	0.7	0.65	0.6	0.57	0.54	0.52	0.5	0.48	0.45	0.43	0.41	0.39	0.38
Single layer on the wall or floor, touching		1.0	0.85	0.79	0.75	0.73	0.72	0.72	0.72	0.71	0.70	-	-	-	-	-
Single layer on the wall or floor, spaced with a clearance of 1 x cable diameter between adjacent cables		1.0	0.94	0.9	0.9	0.9	0.9	0.9	0.9	0.9	0.9	0.9	0.9	0.9	0.9	0.9
Single layer under ceiling, touching		0.95	0.81	0.72	0.68	0.66	0.64	0.63	0.62	0.61	-	-	-	-	-	-
Single layer under ceiling, spaced with a clearance of 1 x cable diameter between adjacent cables		0.95	0.85	0.85	0.85	0.85	0.85	0.85	0.85	0.85	0.85	0.85	0.85	0.85	0.85	0.85

De-rating factors for intermittent periodic duty				
Ambient temperature 30°C / Duty cycle 10 min				
Nominal cross-section mm ²	Duty factor ED %			
	60	40	25	15
0.75	1.00	1.00	1.00	1.00
1	1.00	1.00	1.00	1.00
1.5	1.00	1.00	1.00	1.00
2.5	1.00	1.00	1.04	1.07
4	1.00	1.03	1.05	1.19
6	1.00	1.04	1.13	1.27
10	1.03	1.09	1.21	1.44
16	1.07	1.16	1.34	1.62
25	1.10	1.23	1.46	1.79
35	1.13	1.28	1.53	1.90
50	1.16	1.34	1.62	2.03
70	1.18	1.38	1.69	2.13
95	1.20	1.42	1.74	2.21
120	1.21	1.44	1.78	2.26
150	1.22	1.46	1.81	2.30
185	1.23	1.48	1.82	2.32
240	1.23	1.49	1.85	2.36
300	1.23	1.50	1.87	2.39

De-rating factors for multi-core cables with conductor cross-sections up to 10 mm ²						
Number of loaded cores						
5	7	10	12	14	18	19
0.75	0.65	0.55	0.53	0.50	0.44	0.45

Number of loaded cores						
24	30	36	40	42	61	
0.40	0.37	0.36	0.35	0.35	0.30	

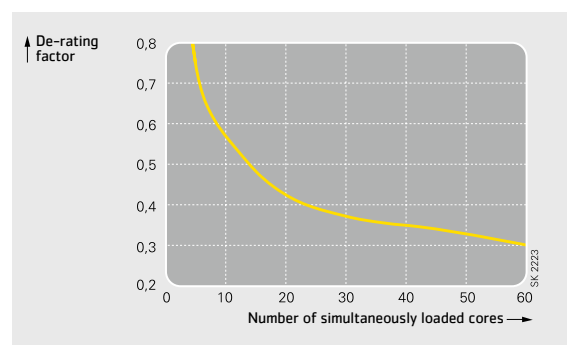

Thermal parameters

The different temperature limits of the individual flexible electric cables for mining applications are summarised in the table on page 191.

Under no circumstances may the values shown be exceeded due to interaction of internal Joule heat and the ambient temperature.

If cables are exposed to radiation, e.g. sunlight, the temperature of the outer sheath of the flexible electric cable can rise to a level which is significantly higher than the ambient temperature. This situation must be compensated for by corresponding reduction of the current-carrying capacity.

The temperatures on the surface of the cable are limits for the ambient temperature.

All insulating and sheathing compounds of the flexible electric cables become stiffer as the temperature drops. If the temperature falls below the specified limit, a point can be reached below which the compounds used become brittle.

In addition to this, more force (sometimes considerably more) is needed for bending a flexible electric cable due to the increase of stiffness of the insulating and sheathing compounds at lower temperatures. This can create problems in the use of the flexible electric cables (e.g. with the reel drive).

The relationship between the bending stiffness of flexible electric cables for mining applications and the temperature is shown in the figure below.

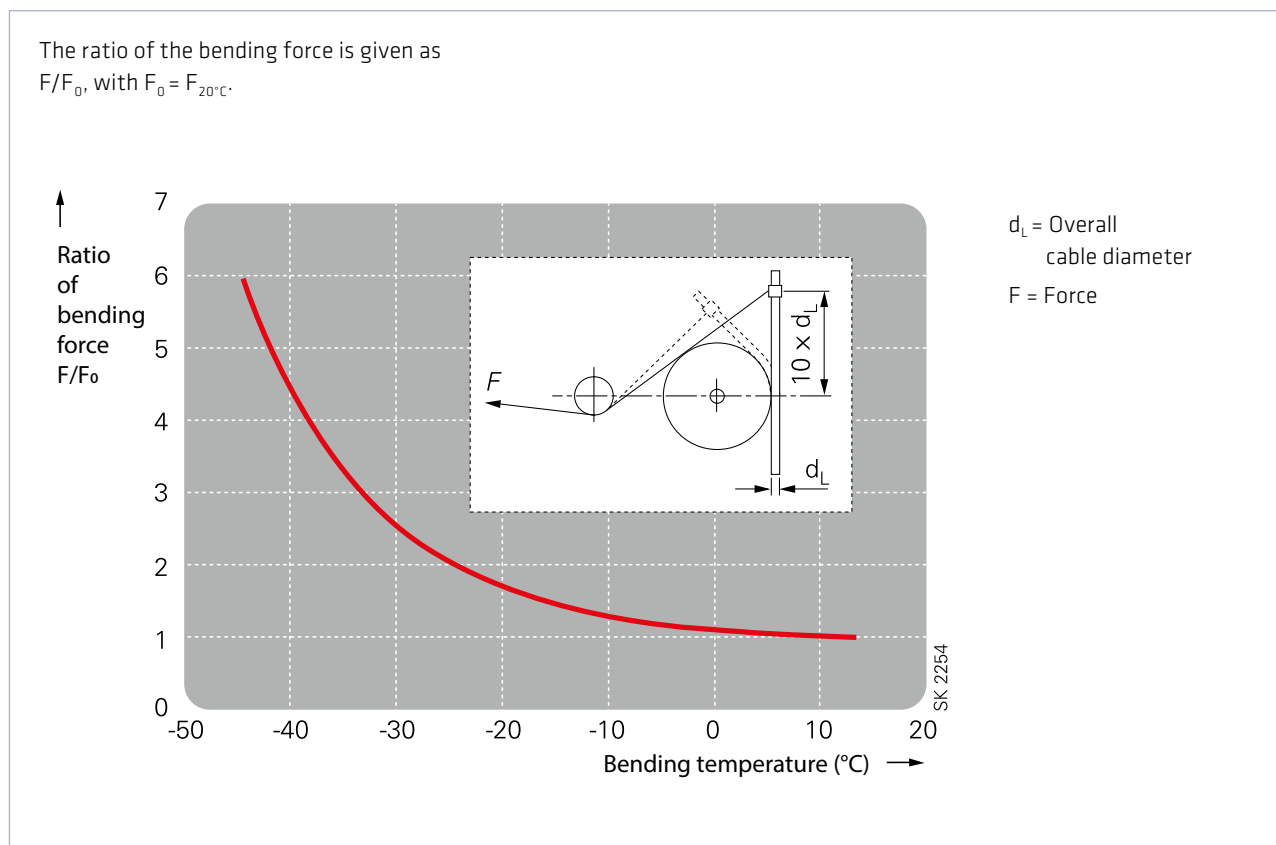

The temperature limits on the surface of the cable are specified to ensure problem-free and healthy operation during forced guidance of flexible electric cables for mining applications, especially while trailing over ground and during reeling operation.

Higher temperatures influence the hardness, abrasion, resistance to tear propagation and the transverse pressure stability of the insulating and sheathing compounds and can thus lead to a reduction of their service life.

Flexible electric cables should be selected, installed and operated so that the expected dissipation of Joule heat is not hindered in any way and therefore no risk of fire is incurred.

Temperature limits of the individual flexible electric cables for mining applications

Flexible cables	Type	Temperature limit during operation, storage, installation and transport (°C)			
		of the conductor during operation	of the conductor during short-circuit	on the surface of the cable, fixed installation	on the surface of the cable, fully flexible installation
CORDAFLEX(S)	NSHTOEU	90	250	-40 to +80	-25 to +60
FELTOFLEX	NTMCW0EU	90	250	-40 to +80	-25 to +80
OPTOFLEX(M)	-	-	-	-40 to +80	-
PROTOLON single-core	NTMCGCW0EU	90	250	-40 to +80	-25 to +60
PROTOLON(M) single-core	(N)TMCWCW0EU	90	250	-40 to +80	-25 to +60
PROTOLON(M)	F-(N)TSCGEW0EU	90	250	-40 to +80	-25 to +60
PROTOLON(M)	R-(N)TSCGEW0EU	90	250	-40 to +80	-35 to +80
PROTOLON(M) with F.O.	R-(N)TSCGEW0EU	90	250	-40 to +80	-35 to +80
PROTOLON(SB)	NTSCGEW0EU	90	250	-40 to +80	-20 to +60
PROTOLON(SB-SAM)	(N)TSCGEW0EU	90	250	-40 to +80	-30 to +60
PROTOLON(ST)	NTSCGEW0EU .../3E	90	250	-40 to +80	-25 to +60
PROTOLON(ST)	NTSCGEW0EU	90	250	-40 to +80	-25 to +60
PROTOMONT	NSSHOEU	90	250	-40 to +80	-25 to +60
PROTOMONT	NSHXOEU	90	250	-40 to +80	-25 to +60
PROTOMONT	NSSHOEU .../3E	90	250	-40 to +80	-25 to +60
PROTOMONT festoon	NTSKCGECW0EU	90	250	-40 to +80	-25 to +60
PROTOMONT EMV-FC	(N)SSHC0EU	90	250	-40 to +80	-25 to +60
PROTOMONT(M+)	(N)SHOEU	90	250	-40 to +80	-25 to +60
PROTOMONT(MSR)	ZYSLGCG0EU	60	150	-40 to +80	-25 to +60
PROTOMONT(MT)	(N)SHOEU	90	250	-40 to +80	-25 to +60
PROTOMONT(V)	NSSHCGE0EU	90	250	-40 to +80	-20 to +60
PROTOMONT(V)	NTSKCGECW0EU	90	250	-40 to +80	-20 to +60
PROTOMONT(VO)	(N)TSKCGEW0EU	90	250	-40 to +80	-20 to +60
PROTOMONT(S)	(N)SSHCGE0EU	90	250	-40 to +80	-20 to +60
PROTOMONT(Z)	NSSHKCGE0EU	90	250	-40 to +80	-20 to +60
PROTOMONT TBM	(N)TSCGEW0EU	90	250	-40 to +80	-20 to +60
PROTOMONT TBM	(N)TSCGECWHXOEU	90	250	-40 to +80	-20 to +60
SUPROMONT	(N)3GHSSYCY	90	250	-40 to +80	+5 to +60
SUPROMONT	(N)3GHSSHCH	90	250	-40 to +80	+5 to +60
TENAX-CTE	NSSHKCGE0EU	90	250	-40 to +80	-25 to +60
TENAX-HTT	(N)TSCGEW0EU	90	250	-40 to +80	-20 to +60
TENAX-LK	NTSKCGEW0EU	90	250	-40 to +80	-25 to +60
TENAX-LUMEN	(N)TSCGEH3S	90	250	-50 to +80	-50 to +60
TENAX-SAS	NTSCGEW0EU	90	250	-50 to +80	-50 to +60

Mechanical parameters

Tensile loads

The tensile loads of copper conductors in flexible electric cables for mining applications as specified by DIN VDE 0298, Part 3, should not exceed 15 N/mm². However, higher values are allowed for some cables as shown in the table below. These values refer to tensile load only.

These maximum permissible limits of tensile load are to be regarded as the sum of the static and dynamic loads.

When the permissible tensile force is being calculated, shields, concentric conductors and split protective-earth conductors as well as integrated control cores and monitoring cores of power cables must not be included in the calculation.

For higher tensile loads, appropriate steps have to be taken such as increasing the bending radii or using special cable designs with stress relieving support elements. In some cases, a shorter service life can be expected. In this case, the cable manufacturer should be consulted.

The maximum permissible tensile load for installing fixed laying flexible cables is 15 N/mm² referred to the cross-section of the conductor.

Maximum tensile loads during installation and operation of flexible electric cables for mining applications			
Flexible cables	Type	DIN VDE N/mm ²	Prysmian Group N/mm ²
CORDAFLEX(S)	NSHTOEU	15	30
FELTOFLEX	NTMCWOEU	15	15
OPTOFLEX(M)	-	-	2000 N for the cable
PROTOLON single-core	NTMCGCWOEU	15	15
PROTOLON(M) single-core	(N)TMCGCWOEU	15	15
PROTOLON(M)	F-(N)TSCGEWOEU	15	15
PROTOLON(M)	R-(N)TSCGEWOEU	15	static: 20 (dynamic: 25)
PROTOLON(M) with F.O.	R-(N)TSCGEWOEU	15	static: 20 (dynamic: 25)
PROTOLON(SB)	NTSCGEWOEU	15	15
PROTOLON(SB-SAM)	(N)TSCGEWOEU	15	20
PROTOLON(ST)	NTSCGEWOEU .../3E	15	15
PROTOLON(ST)	NTSCGEWOEU	15	15
PROTOMONT	NSSH0EU	15	15
PROTOMONT	NSHX0EU	15	15
PROTOMONT	NSSH0EU .../3E	15	15
PROTOMONT festoon	NTSKCGECWOEU	15	15
PROTOMONT EMV-FC	(N)SSHCOEU	15	15
PROTOMONT(M+)	(N)SH0EU	15	15
PROTOMONT(MSR)	2YSLGCG0EU	15	15
PROTOMONT(MT)	(N)SH0EU	15	15
PROTOMONT(V)	NSSHCGE0EU	15	15
PROTOMONT(V)	NTSKCGECWOEU	15	15
PROTOMONT(VO)	(N)TSKCGEWOEU	15	15
PROTOMONT(S)	(N)SSHCGE0EU	15	30
PROTOMONT(Z)	NSSHKCGE0EU	15	40
PROTOMONT TBM	(N)TSCGECWOEU	15	reeling: 15 (on TMB: 30)
PROTOMONT TBM	(N)TSCGECWHX0EU	15	reeling: 15 (on TMB: 30)
SUPROMONT	(N)3GHSSYCY	15	15
SUPROMONT	(N)3GHSSHCH	15	15
TENAX-CTE	NSSHKCGE0EU	15	15
TENAX-HTT	(N)TSCGEWOEU	15	15
TENAX-LK	NTSKCGEWOEU	15	30
TENAX-LUMEN	(N)TSCGEH3S	15	25
TENAX-SAS	NTSCGEWOEU	15	25

Torsional stresses

As a general rule the torsional stresses occurring during operation of flexible electric cables for mining applications are low. In certain applications, such as for example laying on large mobile equipment (cable booms), torsional stresses are unavoidable.

The maximum permissible torsional stresses which occur during operation at entries, slewing gears, windmills, etc., are summarised in the table below.

If the limits are exceeded, this can lead to a reduction in service life. In critical cases, the cable manufacturer should be consulted.

Torsional stresses created by the systems involved (e.g. due to misalignment of cable guidance systems, oblique cable pay out) should be avoided and are not included here.

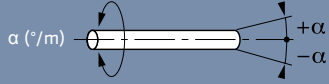
Maximum torsional stresses during operation of flexible electric cables for mining applications			
Flexible cables	Type		
		With semi-conductive rubber layer	With copper core shield
CORDAFLEX(S)	NSHTOEU	±25	-
FELTOFLEX	NTMCWOEU	-	±25
OPTOFLEX(M)	-	±100	-
PROTOLON single-core	NTMCGCWOEU	-	±25
PROTOLON(M) single-core	(N)TMCGCWOEU	-	±25
PROTOLON(M)	F-(N)TSCGEWOEU	±100	-
PROTOLON(M)	R-(N)TSCGEWOEU	±100	-
PROTOLON(M) with F.O.	R-(N)TSCGEWOEU	±100	-
PROTOLON(SB)	NTSCGEWOEU	±100	±25
PROTOLON(SB-SAM)	(N)TSCGEWOEU	±100	±25
PROTOLON(ST)	NTSCGEWOEU .../3E	-	±25
PROTOLON(ST)	NTSCGEWOEU	±100	-
PROTOMONT	NSSH0EU	±100	-
PROTOMONT	NSHX0EU	±100	-
PROTOMONT	NSSH0EU .../3E	-	±25
PROTOMONT festoon	NTSKCGECWOEU	-	±25
PROTOMONT EMV-FC	(N)SSHCOEU	-	±25
PROTOMONT(M+)	(N)SH0EU	±25	-
PROTOMONT(MSR)	2YSLGCG0EU	-	±25
PROTOMONT(MT)	(N)SH0EU	±100	-
PROTOMONT(V)	NSSHCGE0EU	±25	-
PROTOMONT(V)	NTSKCGECWOEU	±25	-
PROTOMONT(VO)	(N)TSKCGEWOEU	±50	-
PROTOMONT(S)	(N)SSHCGE0EU	±50	-
PROTOMONT(Z)	NSSHKCGE0EU	±10	-
PROTOMONT TBM	(N)TSCGECWOEU	-	±25
PROTOMONT TBM	(N)TSCGECWHX0EU	-	±25
SUPROMONT	(N)3GHSSYCY	-	±25
SUPROMONT	(N)3GHSSHCH	-	±25
TENAX-CTE	NSSHKCGE0EU	±50	-
TENAX-HTT	(N)TSCGEWOEU	±100	-
TENAX-LK	NTSKCGEWOEU	±100	-
TENAX-LUMEN	(N)TSCGEH3S	±100	-
TENAX-SAS	NTSCGEWOEU	±100	-

Minimum bending radii

If the bending radii are smaller than those permitted, a reduced service life can be expected depending on the stress conditions. The values given in the table below should be taken as a basis.

The minimum bending radii are shown as the product of the overall diameter of the cable and a factor, which is dependent on the diameter of the cable (e.g.: $3 \times d$).

The minimum permissible bending radii are valid within the specified ambient temperature range (see page 191), subject to the provision that the permissible tensile loads are not exceeded (see page 192).

In critical cases, the cable manufacturer should be consulted.

Minimum permissible bending radius R							
Flexible cables	Fixed installation	Fully flexible operation	For the entry, e.g. at a centre feed point	For forced guidance with reeling operation	For forced guidance with power tracks	For forced guidance with sheaves	Drawing by means of a roller stirrup
Rated voltage U_0/U							
up to 0.6/1 kV	4 x d	5 x d	5 x d	6 x d	5 x d*	7.5 x d	4 x d
above to 0.6/1 kV	6 x d	10 x d	10 x d	12 x d	10 x d	15 x d	8 x d

d = Max. overall cable diameter. * PROTOMONT (V)/(VO), TENAX CTE at max. 5 N/mm²: 2.3 x d

Travel speeds

Flexible electric cables for mining applications are intended for use on mobile equipment and are designed to cope with the technical requirements of the application.

In order to collect, release and move flexible electric cables, there are different cable guidance systems such as reels, drum cars, power tracks, sheave guided cable storage systems as well as sheaves and multi-roller guides.

Mining equipment and consequently also the cable guidance systems are operated at different travel speeds and are therefore subject to stress which can vary from low to very high.

During operation of the mobile equipment, the flexible electric cables are subject to stress such as tension, transverse pressure, torsion and bending. Thus, the travel speed and the acceleration are to be considered as indirect criteria for the stresses applied to the flexible electric cables.

The maximum permissible travel speed for the individual flexible electric cables are summarized in the table below.

If the travel-speed limits are exceeded, a reduction in service life cannot be excluded. The cable manufacturer should be consulted.

Maximum travel speed for flexible electric cables for mining applications					
Flexible cables	Type	Material handling equipment on tracks	Material handling equipment on caterpillar-type running gear	Loader operation of tyre mounted equipment	Rewinding with drum car
		m/min	m/min	m/min	m/min
CORDAFLEX(S)	NSHTOEU	no application	no application	160	100
PROTOLON(M)	R-(N)TSCGEW0EU	120	10	60	100
PROTOLON(M) with F.O.	R-(N)TSCGEW0EU	120	10	60	100
PROTOLON(SB)	NTSCGEW0EU	no application	10	no application	100
PROTOLON(SB-SAM)	(N)TSCGEW0EU	no application	10	no application	100
PROTOMONT EMV-FC	(N)SSHCOEU	no application	no application	no application	100
PROTOMONT(M+)	(N)SHOEU	no application	no application	60	100
PROTOMONT(MT)	(N)SHOEU	no application	no application	no application	60
PROTOMONT(V)	NSSHCGE0EU	Max. travel speed of the coal cutter 15 m/min			
PROTOMONT(V)	NTSKCGECW0EU	Max. travel speed of the coal cutter 15 m/min			
PROTOMONT(VO)	(N)TSKCGEWOEU	Max. travel speed of the coal cutter 15 m/min			
PROTOMONT(S)	(N)SSHCGE0EU	160	160	160	100
PROTOMONT(Z)	NSSHKCGE0EU	Max. travel speed of the coal cutter 15 m/min			
PROTOMONT TBM	(N)TSCGECW0EU	30	30	no application	100
PROTOMONT TBM	(N)TSCGECWHX0EU	30	30	no application	100
TENAX-CTE	NSSHKCGE0EU	Max. travel speed of the coal cutter 15 m/min			
TENAX-HTT	(N)TSCGEW0EU	30	30	no application	100
TENAX-LK	NTSKCGEWOEU	160	160	160	160
TENAX-LUMEN	(N)TSCGEH3S	no application	10	no application	100
TENAX-SAS	NTSCGEW0EU	no application	10	no application	100

Additional tests

Adequate testing of the operating characteristics needed for flexible electric cables for mining applications is not possible with the tests specified by DIN VDE. Our flexible electric cables for mining applications are therefore subject to additional and continuous mechanical tests at the manufacturer's facilities.

These additional tests facilitate time-compressed examination of the running and service characteristics under different kinds of mechanical stress, such as reserved bending strength, running over sheaves, flexing work and reeling operation in relation to tensile load and bending radii.

Reversed bending test

Based on DIN VDE 0281, Part 2

Testing of flexible electric cables for mining applications under increased loads.

- Cable diameter up to 50 mm, maximum tensile load 3000 N.
- Each movement from one extreme position to another (180°) is counted as a cycle.

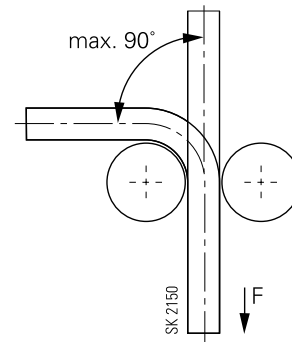

Roller bending test type A

Testing the roller bending characteristics of flexible electric cables for mining applications based on DIN VDE 0282, Part 2.

- Cable diameter up to 50 mm.
- Each movement between the extreme position is counted as a cycle.

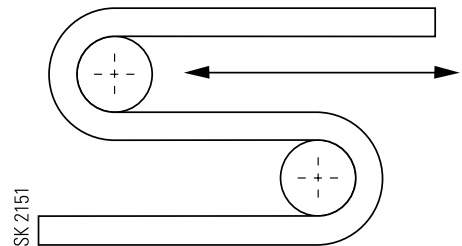

Roller bending test type B - Tender test

Practice-oriented testing of flexible electric cables for mining applications with reference to running and service characteristics.

- Cable diameter from 20 up to 60 mm.
- Each movement between the extreme position is counted as a cycle.

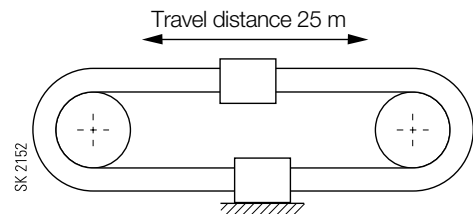

Roller bending test type C - Flexing test

Testing the running characteristics (flexing) of flexible electric cables for mining applications for evaluation of the mechanical service characteristics.

- Cable diameter from 60 up to 120 mm.
- Each movement between the extreme position is counted as a cycle. Moving distance 2 m.

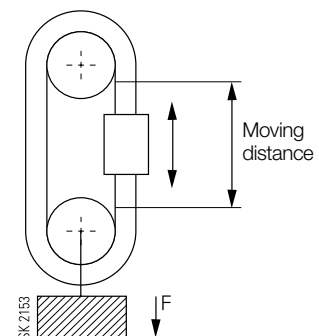

Torsional stress test

The cable is alternately twisted left and right through an angle α by application of the tensile force F .

Torsional angle max. $\pm 360^\circ$
Torsional torque max. 200 Nm
Tensile force max. 4000 N

Test duration at temperatures: -40°C to $+50^\circ\text{C}$.

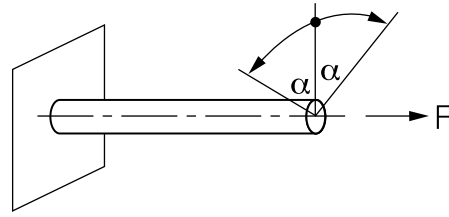

Sheath shifting test

Flexible electric cables for mining applications are generally stressed by dragging over the underground in open-cast mining applications.

The test determines the magnitude of the force required to slide the sheath along the core.

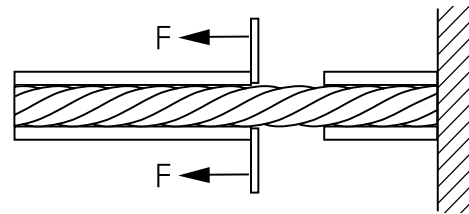

Transverse pressure test

This test demonstrates the behaviour of electric cables subjected to transverse pressure, e.g. as a result of jamming in plant components, being hit by falling stones (blocks of stones), etc.

The test is passed when no electrical event occurs up to the specified value (earth-fault or short-circuit).

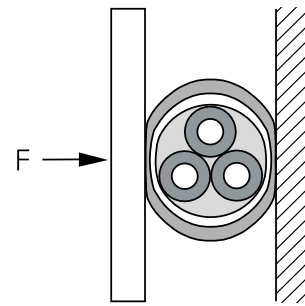

Welding beads test

During constructional and maintenance work on large mobile equipment such as excavators, putting-down machines, etc., welding beads can fall on previously installed electric cables. This test verifies the resistance of the outer sheath to such stresses.

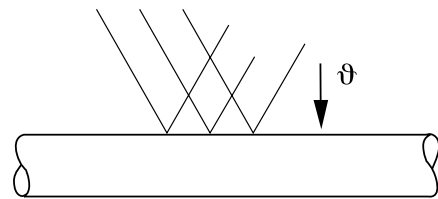

Brine resistance

Automatic material handling and reloading installations (e.g. bunkering and blending plants) are sprayed with brine to prevent them from freezing in order to guarantee smooth trouble-free operation in winter. This test verifies the resistance of the outer sheath of mining-type cables to such stresses.

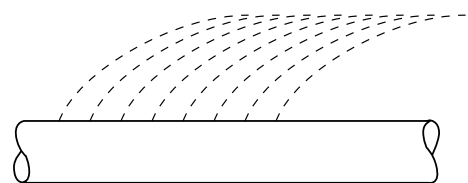

Water resistance

During operation of flexible electric cables for mining applications, the possibility that they will be operated in water over considerable periods of time cannot be excluded. Verification of the resistance to water is carried out according to EN 50525-2-21.

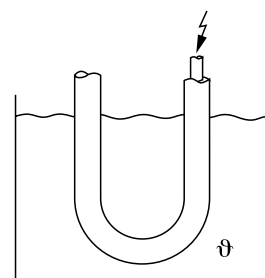

The following tables depicts the test conditions for the individual flexible electric cables for mining applications. Under the severe conditions in mining operation, cables are subjected to considerable mechanical stresses, which by far exceed those defined in the requirement profile according to the VDE standards.

These additional tests assure compliance with the special requirement profile for mining applications and document the suitability of our electric cables for all applications in open-cast and underground mines in a convincing manner.

The tensile loads and the bending and sheave radii are specified and the minimum number of cycles which must be achieved.

The decisive criterion for passing the mechanical test is the number of individual broken wires in the copper conductor and/or non-continuity of the electrical conductor.

In the roller bending tests type A and B, the degree of deformation (cork-screwing effect) is tested additionally.

Test conditions for the individual flexible electric cables for mining applications – table 1					
Additional mechanical tests		PROTOLON(M) R-(N)TSCGEWÖEU PROTOLON(M) with F.O. R-(N)TSCGEWÖEU	PROTOLON(M) F-(N)TSCGEWÖEU	PROTOMONT(MT) (N)SHÖEU	OPTOFLEX(M)
Reversed bending test	Tensile load	20 N/mm ²	5 N/mm ²	5 N/mm ²	300 N
	Bending diameter	10 x D	10 x D	10 x D	250 mm
	Number of cycles	15 000	30 000	30 000	50 000
Roller bending test (test type A) D < 50 mm	Tensile load	15 N/mm ²	2.5 N/mm ²	2.5 N/mm ²	300 N
	Bending diameter	10 x D	10 x D	10 x D	250 mm
	Number of cycles	50 000	30 000	30 000	75 000
Roller bending test (test type B) 20 mm < D < 60 mm	Tensile load	-	-	-	-
	Bending diameter	-	-	-	-
	Number of cycles	-	-	-	-
Roller bending test (test type C) 60 mm < D < 120 mm	Tensile load	20 N/mm ²	20 N/mm ²	15 N/mm ²	-
	Bending diameter	10 x D	10 x D	10 x D	-
	Number of cycles	30 000	15 000	30 000	-
Torsional stress test	Tensile load	10 N/mm ²	10 N/mm ²	10 N/mm ²	300 N
	Torsional angle	± 100 °/m	± 100 °/m	± 100 °/m	± 120 °/m
	Number of cycles	50 000	50 000	50 000	50 000
Sheath shifting test	Pulling speed	20 mm/min	20 mm/min	-	-
	Shifting force	> 20 kN	> 10 kN	-	-
Transverse pressure test	Pressure force	> 150 kN	> 150 kN	> 50 kN	-
	Degree of deformation	< 50 %	< 50 %	< 50 %	-
Resistance to welding beads	Testing temperature	450 °C	450 °C	450 °C	450 °C
	Criterion	no damage	no damage	no damage	no damage
Brine resistance	Storage in	27 % brine solution	27 % brine solution	27 % brine solution	27 % brine solution
	Temperature	60 °C	60 °C	60 °C	60 °C
	Duration	14 days	14 days	14 days	14 days
Water compability acc. to EN 50525-2-21	Duration of storage in water	100 days	100 days	100 days	100 days
	Temperature	50 °C	50 °C	50 °C	50 °C

Test conditions for the individual flexible electric cables for mining applications – table 2

Additional mechanical tests		CORDAFLEX(S) NSHTOEU PROTOMONT(S) (N)SSHCGE0EU	TENAX-LK NTSKCGE0EU	PROTOLON(SB) NTSCGEW0EU PROTOLON (SB-SAM) (N)TSCGEW0EU	TENAX-SAS NTSCGEW0EU	TENAX-LUMEN (N)TSCGEH3S
Reversed bending test	Tensile load	20 N/mm ²	20 N/mm ²	-	20 N/mm ²	20 N/mm ²
	Bending diameter	10 x D	10 x D	-	10 x D	10 x D
	Number of cycles	60 000	60 000	-	30 000	30 000
Roller bending test (test type A) D < 50 mm	Tensile load	5 N/mm ²	5 N/mm ²	-	-	-
	Bending diameter	10 x D	10 x D	-	-	-
	Number of cycles	200 000	200 000	-	-	-
Roller bending test (test type B) 20 mm < D < 60 mm	Tensile load	5 N/mm ²	5 N/mm ²	-	-	-
	Bending diameter	320 mm	320 mm	-	-	-
	Number of cycles	300 000	300 000	-	-	-
Roller bending test (test type C) 60 mm < D < 120 mm	Tensile load	20 N/mm ²	20 N/mm ²	-	20 N/mm ²	20 N/mm ²
	Bending diameter	10 x D	10 x D	-	10 x D	10 x D
	Number of cycles	30 000	30 000	-	30 000	30 000
Torsional stress test	Tensile load	-	-	-	-	-
	Torsional angle	-	-	-	-	-
	Number of cycles	-	-	-	-	-
Sheath shifting test	Pulling speed	-	-	20 mm/min	20 mm/min	20 mm/min
	Shifting force	-	-	> 10 kN	> 10 kN	> 10 kN
Transverse pressure test	Pressure force	-	-	-	-	-
	Degree of deformation	-	-	-	-	-
Resistance to welding beads	Testing temperature	450 °C	450 °C	450 °C	450 °C	450 °C
	Criterion	no damage	no damage	no damage	no damage	no damage
Brine resistance	Storage in	-	-	-	-	-
	Temperature	-	-	-	-	-
	Duration	-	-	-	-	-
Water compability acc. to EN 50525-2-21	Duration of storage in water	-	-	-	-	-
	Temperature	-	-	-	-	-

Test conditions for the individual flexible electric cables for mining applications – table 3

Additional mechanical tests		PROTOLON(ST) NTSCGEW0EU .../3E PROTOLON(ST) NTSCGEW0EU	PROTOMONT(Z) NSSHKCGE0EU	PROTOMONT(V) NSSHCGE0EU PROTOMONT(V) NTSKCGECW0EU PROTOMONT(VO) (N)TSKCGEW0EU	TENAX-CTE NSSHKCGE0EU
Roller bending test (test type C) 60 mm < D < 120 mm	Tensile load	-	30 N/mm ²	5 N/mm ²	5 N/mm ²
	Bending diameter	-	10 x D	5 x D	5 x D
	Number of cycles	-	5 000	3 000	3 000
Resistance to welding beads	Testing temperature	450 °C	450 °C	450 °C	450 °C
	Criterion	no damage	no damage	no damage	no damage

Construction characteristics

Conductors

Conductors for flexible electric cables are designed according to DIN EN 60228 (VDE 0295). Nowadays, the conductors are made of copper (Cu). Aluminium and other materials have not found general acceptance.

In many countries, the design of the conductors according to DIN VDE 0295 is accepted. The regulation corresponds to EN 60228 and IEC 60228.

The conductor classes F, FS and FF are employed for flexible electric cables for mining applications. The conductor classes are divided into nominal cross-sections. The individual conductor classes F, FS and FF and the nominal cross-section are defined by specification of the maximum diameter of the single wires and by the maximum resistance of the conductor at 20 °C (see table).

These flexible conductors are made of bare or tinned annealed copper. The conductors are constructed of many single wires, all of which must have the same diameter.

Overview of common kinds of conductors:

<u>Abbreviation</u>	<u>Designation</u>	<u>Specification/regulation</u>
RE conductor	Circular, solid	DIN VDE 0295 Class 1
RM conductor	Circular, stranded	DIN VDE 0295 Class 2
RMV conductor	Circular, stranded, compacted	DIN VDE 0295 Class 2
F conductor	Finley stranded	DIN VDE 0295 Class 5
FS conductor	Very finely stranded	Prysmian specification
FF conductor	Extremely finely stranded	DIN VDE 0295 Class 6

Conductors – construction characteristics					
Nominal cross-section mm ²	Max. diameter of the single wires mm			Resistance of the conductor at 20 °C Ω/km	
	F conductor (Class S)	FS conductor (Prysmian Group)	FF conductor (Class C)	Bare single wires	Tinned single wires
0.5	0.21	0.16	0.16	39	40.1
0.75	0.21	0.16	0.16	26	26.7
1	0.21	0.16	0.16	19.5	20
1.5	0.26	0.21	0.16	13.3	13.7
2.5	0.26	0.21	0.16	7.98	8.21
4	0.26	0.26	0.16	4.95	5.09
6	0.31	0.26	0.21	3.30	3.39
10	0.31	0.26	0.21	1.91	1.95
16	0.41	0.31	0.21	1.21	1.24
25	0.41	0.31	0.21	0.780	0.795
35	0.41	0.31	0.21	0.554	0.565
50	0.41	0.36	0.31	0.386	0.393
70	0.51	0.36	0.31	0.272	0.277
95	0.51	0.41	0.31	0.206	0.210
120	0.51	0.41	0.31	0.161	0.164
150	0.51	0.41	0.31	0.129	0.132
185	0.51	0.41	0.41	0.106	0.108
240	0.51	0.41	0.41	0.0801	0.0817
300	0.51	0.41	0.41	0.0641	0.0654

Conductors – summary

The conductors used in flexible electric cables for mining applications are summarised in the table below.

The construction of the conductor itself and its design features are open to variation.

The conductor for flexible electric cables is designed according to EN 60228 (VDE 0295), as described in the table below and especially in the table on the previous page.

Conductors used in flexible electric cables for mining applications – summary				
Flexible cables	Type	Conductor		
		Class	Design	
CORDAFLEX(S)	NSHTOEU	FS	Electrolytic copper, tinned	Very finely stranded
FELTOFLEX	NTMCW0EU	F	Electrolytic copper, tinned	Finely stranded
OPTOFLEX(M)	-	Fibre-optics, no copper conductors		
PROTOLON single-core	NTMCGCW0EU	F	Electrolytic copper, tinned	Finely stranded
PROTOLON(M) single-core	(N)TMCGCW0EU	F	Electrolytic copper, tinned	Finely stranded
PROTOLON(M)	F-(N)TSCGEW0EU	F	Bare electrolytic copper	Finely stranded
PROTOLON(M)	R-(N)TSCGEW0EU	FS	Bare electrolytic copper	Very finely stranded
PROTOLON(M) with F.O.	R-(N)TSCGEW0EU	FS	Bare electrolytic copper	Very finely stranded
PROTOLON(SB)	NTSCGEW0EU	F	Electrolytic copper, tinned	Finely stranded
PROTOLON(SB-SAM)	(N)TSCGEW0EU	F	Bare electrolytic copper	Finely stranded
PROTOLON(ST)	NTSCGEW0EU .../3E	F	Electrolytic copper, tinned	Finely stranded
PROTOLON(ST)	NTSCGEW0EU	F	Electrolytic copper, tinned	Finely stranded
PROTOMONT	NSSH0EU	F	Electrolytic copper, tinned	Finely stranded
PROTOMONT	NSHX0EU	F	Electrolytic copper, tinned	Finely stranded
PROTOMONT	NSSH0EU .../3E	F	Bare electrolytic copper	Finely stranded
PROTOMONT festoon	NTSKCGECW0EU	F	Electrolytic copper, tinned	Finely stranded
PROTOMONT EMV-FC	(N)SSHCOEU	F	Electrolytic copper, tinned	Finely stranded
PROTOMONT(M+)	(N)SH0EU	F	Bare electrolytic copper	Finely stranded
PROTOMONT(MSR)	2YSLGCG0EU	F	Bare electrolytic copper	Finely stranded
PROTOMONT(MT)	(N)SH0EU	F	Bare electrolytic copper	Finely stranded
PROTOMONT(V)	NSSHCGE0EU	FS	Electrolytic copper, tinned	Very finely stranded
PROTOMONT(V)	NTSKCGECW0EU	FS	Electrolytic copper, tinned	Very finely stranded
PROTOMONT(VO)	(N)TSKCGE0EU	FS	Electrolytic copper, tinned	Very finely stranded
PROTOMONT(S)	(N)SSHCGE0EU	FS	Electrolytic copper, tinned	Very finely stranded
PROTOMONT(Z)	NSSHKCGE0EU	FS	Electrolytic copper, tinned	Very finely stranded
PROTOMONT TBM	(N)TSCGECW0EU	F	Electrolytic copper, tinned	Finely stranded
PROTOMONT TBM	(N)TSCGECWHX0EU	F	Electrolytic copper, tinned	Finely stranded
SUPROMONT	(N)3GHSSYCY	F	Bare electrolytic copper	Finely stranded
SUPROMONT	(N)3GHSSHCH	F	Bare electrolytic copper	Finely stranded
TENAX-CTE	NSSHKCGE0EU	FS	Electrolytic copper, tinned	Very finely stranded
TENAX-HTT	(N)TSCGEW0EU	F	Bare electrolytic copper	Finely stranded
TENAX-LK	NTSKCGE0EU	FS	Electrolytic copper, tinned	Very finely stranded
TENAX-LUMEN	(N)TSCGEH3S	F	Electrolytic copper, tinned	Finely stranded
TENAX-SAS	NTSCGEW0EU	F	Electrolytic copper, tinned	Finely stranded

Design elements

Figure 1 shows the design elements of a conductor for flexible electric cables for mining applications.

Depending on the cross-section of the conductor, a flexible conductor consists of one or more strands which are laid up around a central strand in several layers. In the diagram, six individual strands (second layer) are laid up around a central strand (first layer). A third layer would then be made from $6 + 6 = 12$ individual strands, arranged around the second layer.

The strands of the flexible conductors consist of many single wires bunched together. The single wires can be laid up (bunched) to the right or left, thus determining the direction of lay. This is shown in figure 2 as the Z direction of lay (right) or the S direction of lay (left). This also applies to a conductor which is laid up of single strands.

Conductor design

The conductor design and the nominal cross-section of the flexible F, FS and FF conductors for flexible electric cables are usually as shows in the table "Conductor design".

Conductor types

Depending on the combination of the individual design elements of a conductor, there are three basic types of conductors (see table "Conductor types").

The main advantage of the uniform-lay conductor is its high flexibility. As a result of its design, the conductor also has a smaller diameter than other types of conductors.

Disadvantages are its susceptibility to torsional loads (unstable) and its poor resistance to axial compression and sharp bending. The uniform-lay conductor is used for all TENAX cables.

The alternating-lay conductor is very stable with respect to torsional loads and is not sensitive to axial compression and sharp bending. A disadvantage is its relatively low flexibility. As a result of its design the many crossing points of the single wires cause a lot of friction, which can lead to early breaking of the conductor, as compared to the other two types of conductors. The alternating-lay conductor has the largest diameter compared to the other two types of conductors.

The design of the opposite-lay conductor best meets the requirements of flexible electric cables for mining applications. It combines the advantages of both the uniform-lay conductor and the alternating-lay conductor without any of their disadvantages. The conductor is highly flexible, remains stable with respect to torsional loads and exhibits high axial compression and sharp bending strength. It has proven its excellent characteristics in many years of practice. The opposite-lay conductor is used for CORDAFLEX, PROTOMONT, SUPROMONT and PROTOLON.

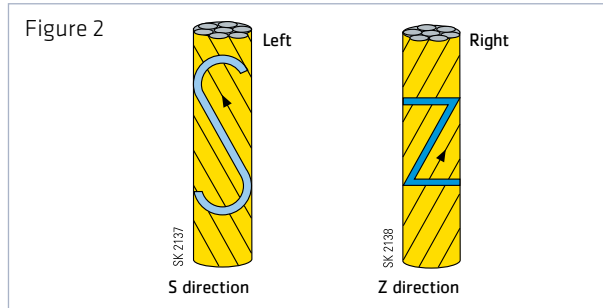
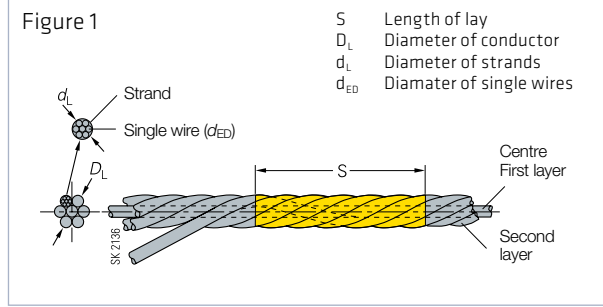

Conductor design				
		F conductor	FS conductor	FF conductor
Bunched		up to 10 mm ²	up to 2.5 mm ²	up to 2.5 mm ²
Stranded		from 16 mm ²	from 4 mm ²	from 4 mm ²

Conductor types				
		Design	Strand	Layer
Uniform-lay conductor		Centre	Z	
		2 nd layer	Z	Z
		3 rd layer	Z	Z
Alternating-lay conductor		Centre	Z	
		2 nd layer	S	Z
		3 rd layer	Z	S
Opposite-lay conductor		Centre	S	
		2 nd layer	S	Z
		3 rd layer	S	Z

Insulating and sheathing compounds

The table below gives an overview of all common compounds used for flexible electric cables. A basic distinction is made between thermoplastics and elastomers:

- Thermoplastics, generally known as plastic, are usually not cross-linked
- Elastomers, generally known as rubber, are always cross-linked

Compounds used for flexible electric cables				
Serial no.	Material	Abbreviation	Type designation*	
			VDE	Harm.
Thermoplastics				
1	Polyvinyl chloride	PVC	Y	V
2	Cross-linked polyvinyl chloride	PVC	X	V4
3	Polyethylenen	PE	2Y	E
4	Cross-linked polyethylenen	XLPE	2X	X
5	Low-pressure polyethylene	PE	2Yn	E2
6	Foam polyethylene	PE	02Y	
7	Polystyrene	PS	3Y	Q3
8	Polyamide	PA	4Y	Q4
9	Polytetrafluor ethylene	PTFE	5Y	E4
10	Perfluor ethylene propylene	PEP	6Y	E5
11	Ethylene tetrafluor ethylene	ETFE	7Y	E6
12	Polyimide	PI	8Y	Q5
13	Polypropylene	PP	9Y	E7
14	Polyvinylidene fluoride	PVDF	10Y	Q6
15	Polyurethane	TPU/PU	11Y	Q
16	Polyterephthalic acid ester	PETP	12Y	Q2
17	Polyester thermoplastic	-	13Y	
18	Perfluor ethylene oxyalkane	PFA	14Y	
19	Polychlorotrifluor ethylene	ECTFE	15Y	
Elastomers				
20	Natural rubber	NR	G	R
21	Synthetic rubber	SR	G	R
22	Styrene-butadiene rubber	SBR	G	R
23	Silicon rubber	SIR	2G	S
24	Isobuthylene-isoprene rubber	IIR	3G	B3
25	Ethylene-propylene rubber	EPR/EPDM	3G	B
26	Ethylene vinylacetate	EVA	4G	G
27	Chloroprene rubber	CR	5G	N
28	Chlorosulfonated polyethylene	CSM	6G	N4
29	Fluor elastomers		7G	
30	Nitrile butadiene rubber	NBR	8G	N5
31	Chlorated polyethylene	CM/CPE	9G	

***Type designation:**

Y: Type designation for a thermoplastic material.

G: Type designation for an elastomeric material.

X: Type designation for a cross-linked thermoplastic material (the letter "X" replaces the "Y" in "2X" for cross-linked polyethylene).

0: Additional designation for foam materials (the zero is placed in front of the relevant type designation, e.g. "02Y" for foamed PE).

The insulating and sheathing compounds, which are employed in flexible electric cables for mining applications constructed according to the existing VDE standards listed below, are compared with respect to the individual requirements in

the table below. The characteristics are specified in DIN VDE 0207 or EN 50290 and allow a preliminary estimation of the properties of these compounds.

Characteristics of insulating and sheathing compounds						
Requirements		Unit	Compound			
			Sheath		Insulation	
			CR/MR		SR	EPR
			5GM3	5GM5	GM1b	3GI3
Max. permissible operating temperature at the conductor		°C	90	90	90	90
Tensile strength before ageing	min.	N/mm ²	10.0	15.0	4.2	4.2
Elongation at break before ageing	min.	%	300	300	200	200
Ageing	at	°C	100 ±2	100 ±2	100 ±2	135 ±2
	over	d	7.0	7.0	7.0	7.0
Change in tensile strength after ageing	max.	%	±30	±30	-	±30
Elongation at break after ageing	min.	%	250	250	200	-
Change in elongation at break after ageing	max.	%	±40	±40	-	±30
Abrasion	max.	mm ³	-	300	-	-
Resistance to tear propagation	min.	N/mm	-	30	-	-
Thermal expansion	at	°C	100 ±2	100 ±2	-	200 ±3
	over	min.	15	15	15	15
	with	N/cm ²	20	20	20	20
	loaded max.	%	175	175	175	175
	relieved max.	%	25	25	25	25
Resistance to oil (ASTM Oil no. 2)	at	°C	100 ±2	100 ±2	-	127 ±1
	over	h	24	24	-	40
	with	bar	-	-	-	5.5 ±1
Change in tensile strength	max.	N/mm ²	±40	±40	-	±30
Change in elongation at break	max.	%	±40	±40	-	±30
Surface resistance at 20 °C	min.	Ω	10 ⁹	10 ⁹	10 ⁹	-
Volume resistance at 20 °C	min.	Ω x cm	-	-	-	10 ¹²

Shield

The shield is a “barrier” against electromagnetic fields and protects electric signals against external signals. The aim is to weaken or stop unwanted signals to such an extent that the wanted data signals can be transmitted without interference in the endangered signalling conductor. There are three basic types of shield structure:

- Overall shield over several cores
- Shielded pairs
- Individually shielded cores.

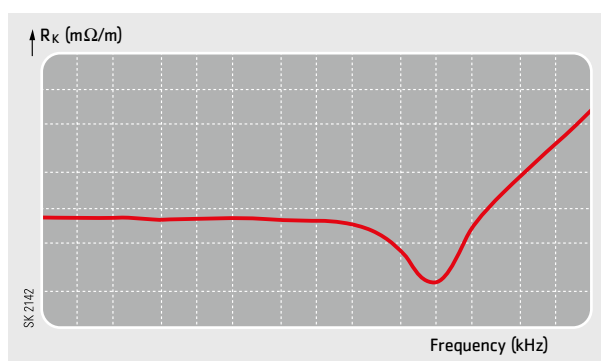

An overall sheath over several cores, which as a rule is situated between the inner and outer sheath of a cable, has not found general acceptance for reeling cables, because as a result of frequent bending the tensile and pressure forces within the cable lead to premature destruction of the shields and to failure of the cable.

Shielded pairs and individually shielded cores, on the other hand, have proven themselves in practice and are successfully used in Prysmian Group cables.

Braided screens are characterized by their transfer impedance which is defined as the ratio of the voltage drop along the shield on the interfered side to the parasitic current on the other side. The transfer impedance R_k (DIN 40500) is given for a specific frequency in mΩ/m and is usually plotted with respect to frequency. The lower the transfer impedance of a shield, the better the screening effect. The transfer impedance of the braided screens usually used for flexible electric cables for mining applications is optimized at 30 MHz and is therefore focussed on data-processing quality.

A typical transfer impedance characteristic is shown in the diagram to the left.

Electrical field control with cables

The cores of MV-reeling and trailing cables of voltage level 6 kV and above are always equipped with inner and outer semiconductive layers made of semiconductive rubber.

The inner and outer semiconductive layers are extruded with the insulation in a single-pass operation. Secure bonding to the insulation is obtained as a result of this method of extrusion.

The inner semiconductive layer prevents build-up of excessive electrical field strength at the individual wires of the flexible conductor and partial discharges between the conductor and the insulation.

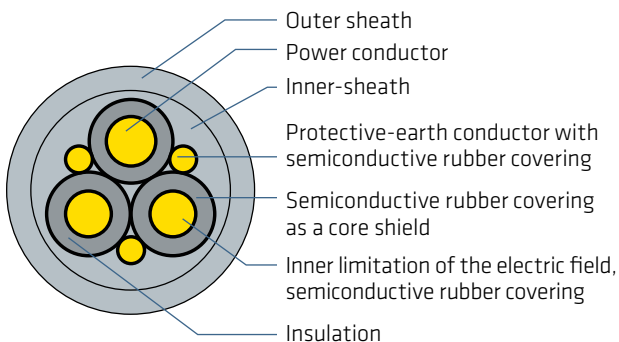

The outer semiconductive layer serves as a core shield and performs the following tasks:

- Protection against electric shock
- Avoidance of partial discharges in the conductor assembly
- Generation of the radial electrical field in the insulation
- Discharge of current in the event of a fault.

The core shield is thus an integral component of the protective-earth conductor.

The resistance between the protective-earth conductor and any point on the outer semiconductive layer must not exceed 500 Ω . The protective-earth conductor, which touches the core shield, is covered with semiconductive rubber and ensures longitudinal conductivity of the system. The figure to the left shows the cross-section of a MV-cable with inner and outer semiconductive layers.

In addition to the electrical requirements, the core shield in flexible electric cables for mining applications must also be able to cope with the high (sometimes very high) mechanical stresses.

Metal shields are more liable to become defective when used in flexible electric cables for mining applications and are inferior to shields made of semiconductive rubber material.

Core arrangement

The basic criteria of the core arrangement for flexible electric cables for mining applications are summarised in the table on page 207.

In round flexible electric cables, the individual cores are arranged by laying them up. Up to four cores are laid up without a central element. Five cores and above are laid up around a centre, which can also consist of three-core stranded elements.

A stretched core in the centre of the flexible cable (as the actual centre or placed in the centre) is not permitted according to the DIN VDE standards. A stretched core at the centre of the flexible cable would quickly result in premature failure of the conductor due to breakage, especially in flexible electric cables for mining applications.

A maximum of three core layers is best for the conductor assembly. Investigations have shown that, if there are more than three layers, the internal stability of the flexible cable and in consequence the service life is reduced as a result of increasing secondary and relative forces between the cores.

Core arrangements in round flexible cables:

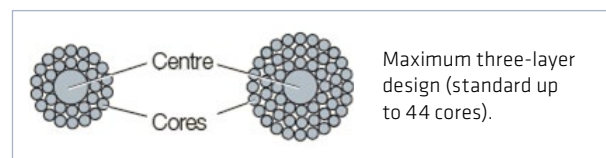
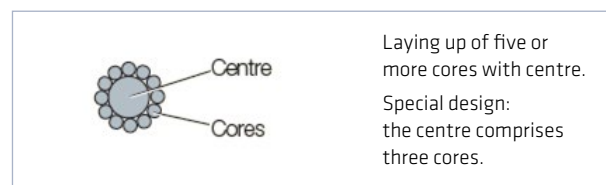
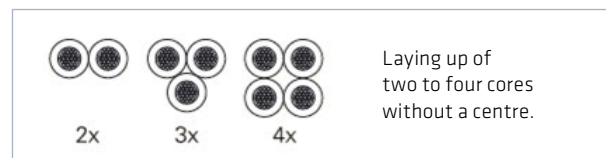

The length of lay S is a design feature used for laying up the conductor assembly (see table) and influences the bending flexibility and the bending stability. The length of lay is an important factor for the service life of flexible electric cables for mining applications.

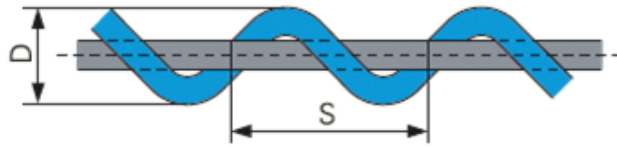

The length of lay S is the length, measured in the direction of the lay, over which a core circumscribes 360° around the laying axis. It is given as a multiple of the diameter D over the conductor assembly, e.g. $S = 8 \times D$

Length of lay for flexible electric cables for mining applications		
Flexible cables	Type	Length of lay
CORDAFLEX(S)	NSHTOEU	5 x D
FELTOFLEX	NTMCW0EU	not applicable
OPTOFLEX(M)	-	Especially laid-up around a GFK support element
PROTOLON single-core	NTMCCW0EU	not applicable
PROTOLON(M) single-core	(N)TMCCW0EU	not applicable
PROTOLON(M)	F-(N)TSCGEW0EU	12 x D
PROTOLON(M)	R-(N)TSCGEW0EU	7 x D
PROTOLON(M) with F.O.	R-(N)TSCGEW0EU	7 x D
PROTOLON(SB)	NTSCGEW0EU	10 x D
PROTOLON(SB-SAM)	(N)TSCGEW0EU	10 x D
PROTOLON(ST)	NTSCGEW0EU .../3E	10 x D
PROTOLON(ST)	NTSCGEW0EU	10 x D
PROTOMONT	NSSH0EU	Power cable: 15 x D (Control cable: 25 x D)
PROTOMONT	NSHX0EU	Power cable: 15 x D (Control cable: 25 x D)
PROTOMONT	NSSH0EU .../3E	20 x D
PROTOMONT festoon	NTSKCGECW0EU	7 x D
PROTOMONT EMV-FC	(N)SSHCOEU	20 x D
PROTOMONT(M+)	(N)SH0EU	10 x D
PROTOMONT(MSR)	2YSLGCG0EU	Laid-up pairs $\geq 25 \times D$ / Laid-up cores $\geq 15 \times D$
PROTOMONT(MT)	(N)SH0EU	Power cable: 15 x D (Control cable: 25 x D)
PROTOMONT(V)	NSSHCGE0EU	6 x D
PROTOMONT(V)	NTSKCGECW0EU	6 x D
PROTOMONT(V0)	(N)TSKCGEW0EU	6 x D
PROTOMONT(S)	(N)SSHCGE0EU	6 x D
PROTOMONT(Z)	NSSHKCGE0EU	6 x D
PROTOMONT TBM	(N)TSCGECW0EU	12 x D
PROTOMONT TBM	(N)TSCGECWHX0EU	12 x D
SUPROMONT	(N)3GHSSYCY	12 x D
SUPROMONT	(N)3GHSSHCH	12 x D
TENAX-CTE	NSSHKCGE0EU	6 x D
TENAX-HTT	(N)TSCGEW0EU	12 x D
TENAX-LK	NTSKCGEW0EU	7 x D
TENAX-LUMEN	(N)TSCGEH3S	6.5 x D
TENAX-SAS	NTSCGEW0EU	6.5 x D

Support elements

Flexible electric cables for mining applications should not be stressed above the limits set out in table “Maximum tensile loads” on page 192 for the permissible tensile forces. If higher tensile forces are expected, support elements have to be provided as part of the structure of the cable. There are several possibilities for integration of support elements in cables.

Two variants are normally used:

- A support element located in the centre of the cable or
- A braid between the inner and outer sheath

The force/elongation diagram in the figure shows the characteristic of these cables with different arrangements of support elements as compared to a cable without a support element.

After a compacting phase, in which the individual cable elements are initially pulled together, until the copper conductor begins to bear the tensile force, the cable without a support element remains linear in the first section of the curve (curve C). In the next phase, elongation increases considerably on a slight increase of force.

Cables with a braid as a support element between the inner and outer sheath behave in the first section of the curve (curve B) in a similar manner to cables without a support element. The braid becomes effective as a support element and bears the applied force only after the force and the consequent elongation have increased over a certain period of time. The tensile force, which is borne, increases with less elongation than that of the cable without a support element. The braid as a support element can prevent the cable, e.g. from tearing.

Cables with a central support element behave differently provided that the support element was correctly dimensioned. The support element bears the tensile forces from the very beginning and thus relieves the copper conductor (curve A).

The force/elongation characteristics of the support elements and of the copper conductors are decisive for correct design of the support element and dimensioning of the flexible cables. The actual design should be worked out in close co-operation with the cable manufacturer.

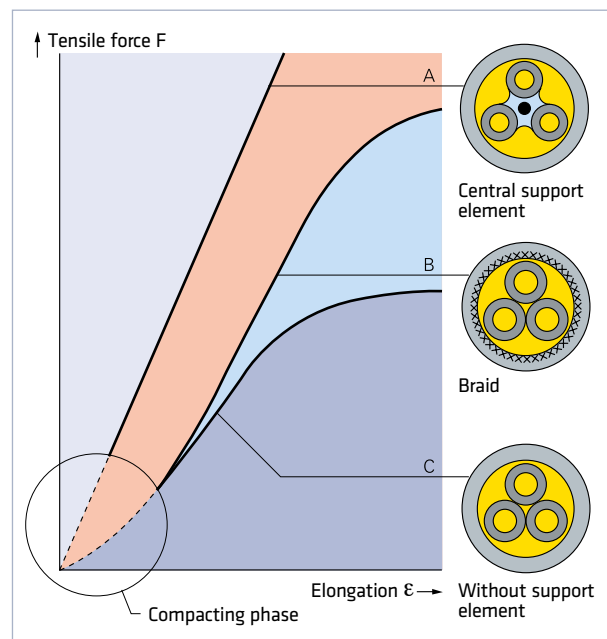

Anti-torsion braid

Flexible electric cables for mining applications are often fitted with an anti-torsion braid between the inner and outer sheath in order to minimize twisting under torsional loads. This applies to CORDAFLEX(S), PROTOLON(M)-R, TENAX-LK, PROTOMONT(S) and TENAX-SAS.

The effect of an anti-torsion braid on the angle of torsion α with increasing torsional moment for comparable cables with and without an anti-torsion braid is shown in the figure.

The flexible cable with anti-torsion braid tends to twist less than the flexible cable without a braid for the same torsional moment.

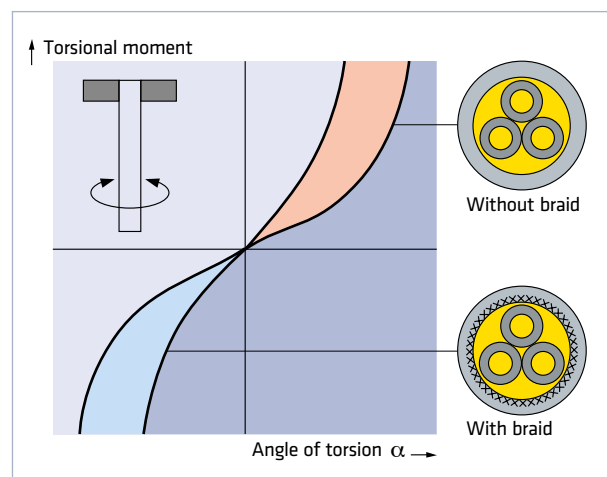

Cable drum overview

Cable drums			
Drum size	Weight kg	Dimensions Ø x width cm	Volume m ³
051	9	50x46	0.09
071	23	71x48	0.19
081	28	80x48	0.26
091	43	90x64	0.45
101	50	100x64	0.70
121	125	125x76	1.09
141	145	140x95	1.37
161	210	160x95	2.01
181	280	180x110	2.80
200	380	200x110	4.24
220	500	224x138	5.44
224	700	240x138	7.26
281	900	280x138	10.10
300	1100	300x170	12.14
320	1200	320x170	18.10
340	1400	340x220	20.43

Local standards

Comparison AWG

AWG (American Wire Gage)		
AWG size	Equivalent cross-section (mm ²)	Closest metrical cross-section (mm ²)
18	0.823	1.0
16	1.31	1.5
14	2.08	2.5
12	3.31	4.0
10	5.26	6.0
8	8.37	10.0
6	13.30	16.0
4	21.15	25.0
2	33.63	35.0
1/0	53.48	50.0
2/0	67.43	70.0
3/0	85.01	95.0

AWG (American Wire Gage)		
AWG size	Equivalent cross-section (mm ²)	Closest metrical cross-section (mm ²)
250 MCM	107.20	120.0
300 MCM	152.00	150.0
350 MCM	177.35	185.0
400 MCM	202.71	185.0
500 MCM	253.35	240.0
600 MCM	303.96	300.0
750 MCM	379.95	400.0
1000 MCM	506.71	500.0

Worldwide Prysmian Group mining cables acc. to local standards

Prysmian Group mining cables				
Brandname	Cable type	Standard	Production location	Application
Australia – Australian Standard (AS)				
MineMaster	Type 209 1.1-11 kV	AS/NZS 1802	Australia	Underground feeder cable for pumps, fans and crushers
MineMaster	Type 210 1.1 kV	AS/NZS 1802	Australia	Underground cable for hand-held boring machines
MineMaster	Type 240 1.1-11 kV	AS/NZS 1802	Australia	Underground feeder cable for continuous miner
MineMaster	Type 241 1.1-11 kV	AS/NZS 1802	Australia	Underground screened cable for continuous miner and feeder
MineMaster	Type 275 1.1 kV	AS/NZS 1802	Australia	Underground cable for high speed reeling on shuttle cars
MineMaster	Type 409 3.3-22 kV	AS/NZS 2802	Australia	Opencast screened cable for trailing application
MineMaster	Type 440 3.3-22 kV	AS/NZS 2802	Australia	Opencast screened cable for trailing application
MineMaster	Type 441 3.3-22 kV	AS/NZS 2802	Australia	Opencast screened cable for trailing application
MineMaster	Type 450 3.3-33 kV	AS/NZS 2802	Australia	Opencast screened cable for trailing application
Czech Republic				
	1-CHBU 0.6/1 kV	Based on DIN VDE 0250	Germany	Semi-flexible installation
	3-CHBU 1.8/3 kV	Based on DIN VDE 0250	Germany	Semi-flexible installation
	6-CHBU 3.6/6 kV	Based on DIN VDE 0250	Germany	Semi-flexible installation
	6-CHCU 3.6/6 kV	Based on DIN VDE 0250	Germany	Semi-flexible installation along conveyor belts
	6-CHCU-TT 3.6/6 kV	Based on DIN VDE 0250	Germany	Cable for reeling application
	6-CHCU-TTAR 3.6/6 kV	Based on DIN VDE 0250	Germany	Cable for reeling and trailing application
	35-CHVU 20/35 kV	Based on DIN VDE 0250	Germany	Cable for slow reeling and trailing application
Great Britain – British Standard (BS)				
PROTOMONT	Type 7 - 7M - 7S 1.1 kV	BS 6708	Germany	Flexible rubber cable for use in underground mines
PROTOMONT	Type 307 - 307M - 307S 3.3 kV	BS 6708	Germany	Flexible rubber cable for use in underground mines
PROTOMONT	Type 201 - 211 1.1 kV	BS 6708	Germany	Pliable wire armoured cables for underground use
PROTOMONT	Type 62 - 63 - 64 1.1 kV	BS 6708	Germany	Pliable wire armoured for use as roadway extension and lighting cables
PROTOMONT	Type 321 - 331 3.3 kV	BS 6708	Germany	MV pliable wired armoured for use as mine roadway extension cables
PROTOMONT	Type 631 6.6 kV	BS 6708	Germany	MV pliable wired armoured for use as mine roadway extension cables
PROTOMONT	Type 506 - 512 - 518 - 524	BS 6708	Germany	Pliable wire armoured signaling and auxiliary cables
India – Indian Standard (IS)				
	TYPE FT7 1.1 kV	IS 14494	Germany	Flexible rubber cable for use in underground mines
	TYPE FT10 1.1 kV	IS 14494	Germany	Flexible rubber cable for use in underground mines
	TYPE FT11 1.1 kV	IS 14494	Germany	Flexible rubber cable for use in underground mines
	TYPE PLC2 - PLC3 - PLC4 - PLC5 1.1 kV	IS 14494	Germany	Pliable wire armoured cables for underground use
PROTOMONT	Type 506 - 524	IS 14494	Germany	Pliable wire armoured signaling and auxiliary cables
Serbia				
	EPN 78	SRPS N.C5.374	Germany	MV cable for reeling, trailing and semi-flexible application
USA				
ANACONDA	Type W 2kV	ICEA S-75-381	USA	Flexible rubber cable for general purpose
ANACONDA	Type G - G-GC 2 kV	ICEA S-75-381	USA	Flexible rubber cable for general purpose
ANACONDA	Type SHD-GC 2-25 kV	ICEA S-75-381	USA	Flexible MV cable for trailing in opencast and underground mines
ANACONDA	Type MP-GC 5-25 kV	ICEA S-75-381	USA	Semi-flexible installation

Linking the future

Issue: March 2019

All sizes and values without tolerances are reference values. Specifications are for product as supplied by Prysmian Group: any modification or alteration afterwards of product may give different result. The content contained within this document must not be copied, reprinted or reproduced in any form, either wholly or in part, without the written consent of Prysmian Group. The information is believed to be correct at the time of issue. Prysmian Group reserves the right to amend this specification without prior notice. This specification is not contractually valid unless specifically authorised by Prysmian Group.

Prysmian Group

Prysmian Kabel und Systeme GmbH
Ph: +49 (0) 30 3675 40
E-mail: kontakt@prysmiangroup.com
www.prysmiangroup.de

